

Department of the Army
Pamphlet 385-63

Safety

Range Safety

Headquarters
Department of the Army
Washington, DC
16 April 2014

UNCLASSIFIED

SUMMARY of CHANGE

DA PAM 385-63
Range Safety

This major revision, dated 16 April 2014-

- o Provides clarification on the prohibition of using contractors as range officers in charge (para 1-5a).
- o Updates signage and flag requirements (paras 2-2a, 2-2g, and 8-4a).
- o Modifies Army requirements for use of batwing surface danger zone (paras 3-2b(2) and 4-1c).
- o Provides additional danger zones information, to include tabular data, for firing small arms (tables 4-9, 4-10, 4-11, 4-14, and 4-17).
- o Adds range safety information for small caliber dummy, drill, and inert ammunition (para 4-3).
- o Adds range safety warnings for nonlethal weapons used on operational training ranges (para 14-3).
- o Provides danger zone requirements for the Spider XM 7 Network Command Munition, M2 and M4A1 Selectable Lightweight Attack Munition, M3 Demolition Attack Munition, Grenade Rifle Entry Munition, and Rifle Launched Entry Munition (paras 15-7e, 15-13, and 15-14).
- o Provides clarification to procedural guidance for the institutional laser range safety authority (para 16-2).
- o Adds requirement for exercise emergency action plans (para 17-3b).
- o Updates and adds technical data in the text, figures, and tables (throughout).
- o Makes administrative changes (throughout).

Safety

Range Safety

By Order of the Secretary of the Army:

RAYMOND T. ODIERNO
General, United States Army
Chief of Staff

Official:



GERALD B. O'KEEFE
Administrative Assistant to the
Secretary of the Army

History. This publication is a major revision.

Summary. The Army and the Marine Corps will use this pamphlet in conjunction with AR 385–63 and MCO 3570.1C to establish and maintain a comprehensive range safety program.

Applicability. The standards and procedures in this pamphlet apply to all personnel and range operations and activities on Army or Marine Corps controlled property or within Army or Marine Corps jurisdiction. The provisions of this pamphlet apply in peacetime and contingency operations and are advisory for actual combat operations. Except for airspace and water

traffic safety requirements, these provisions do not apply to development, proof and function test ranges, or laboratories. However, Army commands, Army Service component commands, direct reporting units, and Marine Corps installations having such ranges and laboratories are required to develop and apply alternate standards that are appropriate to the mission and that ensure the preservation of life and property.

Proponent and exception authority.

The proponent of this pamphlet is the Director of Army Staff. The proponent has the authority to approve exceptions or waivers to this regulation that are consistent with controlling law and regulations. The proponent may delegate this approval authority, in writing, to a division chief within the proponent agency or its direct reporting unit or field operating agency, in the grade of colonel or the civilian equivalent. Activities may request a waiver to this regulation by providing justification that includes a full analysis of the expected benefits and must include formal review by the activity's senior legal officer. All waiver requests will be endorsed by the commander or senior leader of the requesting activity and forwarded through their higher headquarters to the policy proponent. Refer to AR 25–30 for specific guidance.

Suggested improvements. Users are invited to send comments and suggested improvements on DA Form 2028 (Recommended Changes to Publications and Blank Forms) directly to Headquarters, Department of the Army, Director of Army Safety Office (DACS–SF), 9351 Hall Road, Building 1456, Fort Belvoir, VA 22060–5860. Marine Corps users are invited to submit comments and suggested improvements to the Commanding General, Marine Corps Combat Development Command (C465), 2079 Barnett Avenue, Quantico, VA 22134–5001.

Distribution. This pamphlet is available to Army users in electronic media only and is intended for command levels A, B, C, D, and E for the Active Army, the Army National Guard/Army National Guard of the United States, and the U.S. Army Reserve. Publication and distribution to authorized users for Marine Corps commands are indicated in the Table of Allowances for Publications.

Contents (Listed by paragraph and page number)

Chapter 1

Introduction, page 1

Purpose • 1–1, page 1

References • 1–2, page 1

Explanation of abbreviations and terms • 1–3, page 1

Deviations • 1–4, page 1

Requirements for range safety certification programs • 1–5, page 2

Chapter 2

Ranges, page 3

Restricting access to and activities on impact areas • 2–1, page 3

*This pamphlet supersedes DA Pam 385–63, dated 30 January 2012.

Contents—Continued

Posting warning signs, markers, and flags • 2-2, *page 4*
Controlling other range usage • 2-3, *page 5*
Coordinating use of special use airspace • 2-4, *page 5*
Small Arms Range Safety Area (Army) • 2-5, *page 6*
Coordinating use of navigable waterways • 2-6, *page 7*
Army safety requirements for indoor firing ranges and shoothouses • 2-7, *page 7*
Marine Corps safety requirements for indoor firing ranges • 2-8, *page 10*
Recreational ranges • 2-9, *page 10*
Ammunition and explosive items on ranges • 2-10, *page 10*
Range personal protective equipment requirements • 2-11, *page 12*
Army requirements for areas known to contain improved conventional munitions and sub-munitions • 2-12, *page 12*

Chapter 3

Danger Zones, *page 14*

General • 3-1, *page 14*
Types of danger zones • 3-2, *page 14*
Authorization for personnel within danger zones • 3-3, *page 24*

Chapter 4

Small Arms, *page 25*

Firing conditions • 4-1, *page 25*
Surface danger zones • 4-2, *page 25*
Small caliber dummy, drill, and inert ammunition • 4-3, *page 45*

Chapter 5

Grenades and Grenade Launchers, *page 45*

Hand grenades • 5-1, *page 45*
Grenade launchers and grenade machine guns • 5-2, *page 49*

Chapter 6

Antitank Rockets, *page 54*

Firing conditions • 6-1, *page 54*
Surface danger zone • 6-2, *page 54*

Chapter 7

Antitank Guided Missiles, *page 65*

BGM-71 and BTM-71 series tube launched, optically-tracked, wire-guided missiles • 7-1, *page 65*
FGM-148 Javelin guided missile • 7-2, *page 73*

Chapter 8

Tank/Fighting Vehicle Gunnery, *page 79*

Tank/fighting vehicle firing conditions • 8-1, *page 79*
Surface danger zone • 8-2, *page 79*
Fighting vehicles • 8-3, *page 88*
Firing vehicle status designations • 8-4, *page 99*
Sub-caliber tank/fighting vehicle gunnery devices • 8-5, *page 100*
Grenade launchers • 8-6, *page 100*
Close support of ground personnel • 8-7, *page 104*
Weapons effect signature simulator • 8-8, *page 104*
Hazardous impulse noise exposure • 8-9, *page 104*

Chapter 9

Mortars, *page 107*

Firing conditions • 9-1, *page 107*
Surface danger zones • 9-2, *page 107*

Contents—Continued

Chapter 10

Field Artillery, *page 110*

Procedures and precautions • 10-1, *page 110*

Safety certification program • 10-2, *page 110*

Field artillery cannons • 10-3, *page 110*

Field artillery cannon surface danger zones • 10-4, *page 111*

Bunkers and fighting vehicles • 10-5, *page 112*

Overhead fire • 10-6, *page 113*

Expeditionary Fire Support System M327 120mm rifled towed mortar • 10-7, *page 113*

Anti-personnel ammunition (Army) • 10-8, *page 115*

M712 Copperhead cannon-launched guided projectile (Army) • 10-9, *page 117*

Flight corridors (refer to chapter 11 for aviation range safety) • 10-10, *page 119*

Improved conventional munitions • 10-11, *page 123*

Multiple Launch Rocket System and High Mobility Artillery Rocket System • 10-12, *page 124*

Multiple Launch Rocket System/High Mobility Artillery Rocket System reduced range practice rocket • 10-13, *page 128*

Chapter 11

Aviation Range Safety, *page 135*

General • 11-1, *page 135*

Firing operations, general requirements • 11-2, *page 136*

Firing conditions, general procedures • 11-3, *page 137*

Firing conditions, specific requirements • 11-4, *page 138*

Unmanned aircraft systems considerations • 11-5, *page 141*

Weapon danger zone program methodology • 11-6, *page 141*

Weapon danger zone tool • 11-7, *page 142*

Applying the weapon danger zone tool • 11-8, *page 142*

Rotary wing surface danger zones • 11-9, *page 143*

HELLFIRE missile (semi-active laser) designation criteria • 11-10, *page 144*

AGM-114 A/F and AGM-114 K/N HELLFIRE missile weapon danger zones/surface danger zones • 11-11, *page 145*

AGM-114 P/P+/R HELLFIRE missile • 11-12, *page 145*

HELLFIRE missile maximum altitude • 11-13, *page 145*

Chapter 12

Air Defense Artillery Weapon Systems, *page 155*

General • 12-1, *page 155*

Firing conditions-general requirements • 12-2, *page 155*

FIM-43 Redeye guided missile (Army) • 12-3, *page 156*

FIM-92 Stinger guided missile • 12-4, *page 157*

MIM-72 Chaparral guided missile • 12-5, *page 159*

MIM-104 PATRIOT guided missile • 12-6, *page 161*

MIM-23B Improved Hawk guided missile (Army) • 12-7, *page 162*

Trajectory corridor • 12-8, *page 166*

Chapter 13

Chemical Agents and Smoke, *page 166*

Chemical agents • 13-1, *page 166*

Riot control agents • 13-2, *page 166*

Smoke • 13-3, *page 168*

Smoke pots • 13-4, *page 168*

Oil smoke candles • 13-5, *page 168*

Contents—Continued

Chapter 14

Non-Lethal Weapons, page 168

Definition • 14-1, *page 168*

General • 14-2, *page 169*

Surface danger zones • 14-3, *page 169*

12-gauge shotgun, M1012 (AA51), M1013 (AA52), and bean bag (AA29) projectiles • 14-4, *page 169*

40mm M1006 (BA06) sponge grenade • 14-5, *page 170*

40mm grenade foam rubber baton (BA07), rubber ball grenade (BA08), and M1029 (BA13) • 14-6, *page 171*

Rubber ball grenade (GG04) • 14-7, *page 172*

M5 modular crowd control munition (WA97) • 14-8, *page 174*

M84 stun grenade (GG09) • 14-9, *page 175*

M98 (FZ16) and M99 (FZ17) 66mm non-lethal grenade • 14-10, *page 176*

Launched electrode stun device • 14-11, *page 178*

M104 non-lethal bursting hand grenade • 14-12, *page 179*

Non-lethal/tube launched munition system • 14-13, *page 179*

Special Effects Small Arms Marking System (Marine Corps) • 14-14, *page 181*

Close combat mission capability kit (Army) • 14-15, *page 182*

Chapter 15

Mines, Firing Devices, Trip Flares, Simulators, and Explosive Charges, page 182

General • 15-1, *page 182*

Firing devices • 15-2, *page 185*

Shaped charges • 15-3, *page 185*

Bangalore torpedoes • 15-4, *page 185*

Mine-clearing line charge • 15-5, *page 185*

Cratering charges • 15-6, *page 189*

Mines • 15-7, *page 189*

Firing devices • 15-8, *page 196*

M48 and M49 trip flares • 15-9, *page 196*

Simulators • 15-10, *page 196*

Safety requirements for firing aerial pyrotechnics (Marine Corps only) • 15-11, *page 198*

Training conducted in explosive entry techniques • 15-12, *page 198*

M2 and M4A1 Selectable Lightweight Attack Munition and the M3 Demolition Attack Munition • 15-13, *page 198*

Rifle Launched Entry Munition and Grenade, Rifle Entry Munition • 15-14, *page 199*

Chapter 16

Laser Range Safety, page 203

General • 16-1, *page 203*

Procedural guidance • 16-2, *page 204*

Laser range certification • 16-3, *page 207*

Laser range design • 16-4, *page 207*

Other safety considerations • 16-5, *page 207*

Laser accident/incident reporting • 16-6, *page 208*

Chapter 17

Live-Fire Exercises, page 208

Safety during live-fire exercises • 17-1, *page 208*

Information for commanders • 17-2, *page 208*

Exercise planning • 17-3, *page 209*

Firing precautions • 17-4, *page 209*

Fire control • 17-5, *page 211*

Maneuver in temporary impact areas • 17-6, *page 211*

Air support • 17-7, *page 211*

Appendix A. References, page 213

Contents—Continued

Table List

- Table 1–1: Officer In Charge and Range Safety Officer appointment requirements, *page 2*
- Table 2–1: Breathing zone exposure limits for intermittent atmospheric lead exposures (Army), *page 9*
- Table 2–2: Personal protective equipment, *page 12*
- Table 4–1: Surface danger zone data for 12-gauge ammunition small arms direct-fire weapons, *page 34*
- Table 4–2: Surface danger zone data for all small arms blank ammunition with blank firing adapter, *page 34*
- Table 4–3: Surface danger zone data for .22 caliber ammunition small arms direct-fire weapons, *page 34*
- Table 4–4: Surface danger zone data for 9mm small arms direct-fire weapons, *page 35*
- Table 4–5: Surface danger zone data for .38 caliber small arms direct-fire weapons, *page 35*
- Table 4–6: Surface danger zone data for .45 caliber small arms direct-fire weapons, *page 35*
- Table 4–7: Surface danger zone data for 5.56mm small arms direct-fire weapons, *page 36*
- Table 4–8: Surface danger zone data for 5.56mm M855A1 enhanced performance round (ball), *page 36*
- Table 4–9: Surface danger zone data for 5.56mm Cartridge, M856A1 Tracer, *page 37*
- Table 4–10: Surface danger zone data for 5.56mm Cartridge, MK301 Dim Tracer, *page 38*
- Table 4–11: Surface danger zone data for 5.56mm Cartridge, M1037 Short Range Training Ammunition, *page 38*
- Table 4–12: Surface danger zone data for 7.62mm small arms direct-fire weapons, *page 39*
- Table 4–13: Surface danger zone data for M993 7.62mm armor piercing, *page 39*
- Table 4–14: Surface danger zone data for 7.62mm Cartridge, M276 Dim Tracer, *page 40*
- Table 4–15: Surface danger zone data for M973 Ball and M974 Tracer 7.62mm short range training ammunition, *page 41*
- Table 4–16: Surface danger zone data for MK 248 MOD 0 .300 Winchester Magnum small arms direct-fire ammunition, *page 41*
- Table 4–17: Surface danger zone data for MK 248 MOD 1 .300 Winchester Magnum small arms direct-fire ammunition, *page 42*
- Table 4–18: Surface danger zone data for .50 caliber small arms direct-fire, *page 43*
- Table 4–19: Surface danger zone data for M903 .50 caliber sabot light armor penetrator, *page 43*
- Table 4–20: Surface danger zone data for M962 .50 caliber sabot light armor penetrator-T, *page 44*
- Table 4–21: Surface danger zone data for .50 caliber MK211, MK211–0/API–T, *page 44*
- Table 4–22: Surface danger zone data for 20 mm small arms direct-fire weapons, *page 44*
- Table 4–23: Surface danger zone data for 30 mm small arms direct-fire weapons, *page 45*
- Table 5–1: Surface danger zone dimensions for MK32, M79, M203, and M320 40mm grenade launcher, *page 50*
- Table 5–2: Surface danger zone dimensions for MK19, MOD3 40mm grenade machine gun, *page 50*
- Table 6–1: Antitank rocket launcher surface danger zone criteria, in meters, *page 55*
- Table 6–2: Maximum ranges at various quadrant elevations for the 35 mm M73 practice rocket, *page 55*
- Table 6–3: Multi- role anti-armor antipersonnel weapon systems surface danger zone criteria, in meters, *page 57*
- Table 6–4: M136 AT4 surface danger zone criteria, in meters, *page 60*
- Table 6–5: Shoulder-launched multipurpose assault weapon surface danger zone criteria, in meters, *page 62*
- Table 7–1: TOW missile system configuration and range distances, *page 67*
- Table 7–2: Javelin missile surface danger zone criteria, in meters, *page 73*
- Table 7–3: Javelin Block 1 missile surface danger zone criteria, in meters, *page 74*
- Table 7–4: Javelin Block 1 surface danger zone variable criteria, *page 74*
- Table 8–1: General tank cannon cartridge surface danger zone criteria, *page 80*
- Table 8–2: Select tank cannon cartridge surface danger zone criteria, *page 82*
- Table 8–3: Surface danger zone parameters for 120mm Target Practice Multi Purpose -Tracer Cartridge M1002, *page 83*
- Table 8–4: Surface danger zone criteria for M865 and M1002 sabot petal discard hazard, *page 85*
- Table 8–5: Surface danger zone criteria for firing M968, 35mm tank precision gunnery inbore device cartridge corresponding to target ranges, *page 87*
- Table 8–6: 25mm surface danger zone criteria, *page 89*
- Table 8–7: Surface danger zone parameters for 30mm MK239 TP–T (Fighting Vehicle - Elevation Restriction), *page 91*
- Table 8–8: Surface danger zone parameters for 30mm MK238 MOD 1 HEI–T and MK266 MOD 1 HEI–T (Fighting Vehicle - Elevation Restriction), *page 91*

Contents—Continued

- Table 8–9: Surface danger zone parameters for 30mm MK264 Multi-Purpose Low Drag (MPLD)-T (Fighting Vehicle - Elevation Restriction), *page 92*
- Table 8–10: Surface danger zone parameters for 30mm MK310 Programmable Air Burst Munition (PABM)-T (Fighting Vehicle - Elevation Restriction), *page 92*
- Table 8–11: Surface danger zone parameters for 30mm MK258 and MK268 APFSDS–T (Fighting Vehicle - Elevation Restriction), *page 93*
- Table 8–12: Surface danger zone parameters for MK239 TP- T 30mm (free gun - no elevation restriction), *page 93*
- Table 8–13: Surface danger zone parameters for MK238 MOD 1 HEI–T and MK266 MOD 1 HEI–T 30mm (free gun - no elevation restriction), *page 94*
- Table 8–14: Surface danger zone parameters for MK264 MPLD- T 30mm (free gun - no elevation restriction), *page 94*
- Table 8–15: Surface danger zone parameters for MK310 PABM- T 30mm (free gun - no elevation restriction), *page 95*
- Table 8–16: Surface danger zone parameters for MK258 and MK268 APFSDS- T 30mm (free gun - no elevation restriction), *page 95*
- Table 8–17: Sabot Surface danger zone parameters for MK 258 and MK268 APFSDS- T 30mm (all firing conditions), *page 96*
- Table 8–18: Sub-caliber devices surface danger zone criteria, *page 100*
- Table 8–19: Exposure limits to hazardous impulse noise from 105mm main gun cartridges (per 24 hours), *page 105*
- Table 8–20: Exposure limits to hazardous impulse noise from tank main gun for selected cartridges 120mm (per 24 hours), *page 105*
- Table 8–21: Hazardous impulse noise contours for various tank/vehicle cannon cartridges, *page 106*
- Table 9–1: Mortar surface danger zone criteria (in meters), *page 108*
- Table 9–2: Basic impact area dimensions, *page 108*
- Table 10–1: Basic impact area dimensions for field artillery cannons, *page 112*
- Table 10–2: Field artillery cannon surface danger zone criteria, *page 112*
- Table 10–3: Heights of burst above occupied fighting vehicles, *page 113*
- Table 10–4: Expeditionary Fire Support System 120mm (rifled) mortar surface danger zone criteria (Marine Corps), *page 113*
- Table 10–5: Anti-personnel ammunition surface danger zone criteria, *page 116*
- Table 10–6: Maximum range data sources for improved conventional munitions, *page 123*
- Table 10–7: Secondary danger zones (A, B, and C) for improved conventional munitions, *page 123*
- Table 10–8: Sub-missile drift factors for improved conventional munitions, *page 124*
- Table 10–9: Multiple Launch Rocket System/High Mobility Artillery Rocket System surface danger zone criteria, *page 125*
- Table 10–10: Multiple Launch Rocket System/High Mobility Artillery Rocket System reduced range practice rocket surface danger zone criteria (M28A1/A2), *page 129*
- Table 11–1: Friendly position marking requirements, *page 140*
- Table 11–2: Aerial rocketry surface danger zone criteria, *page 146*
- Table 11–3: Army rotary wing HELLFIRE missile firing modes and restriction requirements, *page 155*
- Table 12–1: Improved Hawk corridor dimensions, *page 166*
- Table 14–1: Surface danger zone for 12-gauge, hard and soft targets, *page 169*
- Table 14–2: M1006 (BA06) 40mm sponge grenade, *page 171*
- Table 14–3: 40mm grenade foam rubber baton (BA07), rubber ball grenade (BA08), and M1029 (BA13) grenade, *page 172*
- Table 14–4: Surface danger zone parameters for the 66mm M98 and M99 Grenades, *page 177*
- Table 14–5: Non-lethal/tube launched munition system maximum allowable environment, *page 180*
- Table 14–6: Close combat mission capability kit (Army), *page 182*
- Table 15–1: Dimensions of sand cushion, *page 200*
- Table 15–2: Safe distances for personnel (near bare charges), *page 201*
- Table 15–3: Hearing protection distances, *page 201*
- Table 15–4: Minimum safe distances between radio frequency transmitters and electric blasting operations, *page 201*
- Table 15–5: Minimum safe distances between television and FM broadcast transmitters and electric blasting operations, *page 202*
- Table 15–6: Minimum safe distances between mobile RF transmitters and electric blasting operations, *page 203*

Contents—Continued

Table 15–7: Surface danger zone criteria for the Rifle Launched Entry Munition and Grenade Rifle Entry Munition (hard and soft targets), *page 203*

Figure List

- Figure 2–1: Sample warning signs, *page 4*
- Figure 3–1: Basic elements of a laser surface danger zone, *page 15*
- Figure 3–2: Cone surface danger zone for small arms direct-fire weapons without explosive projectiles, *page 16*
- Figure 3–3: Batwing surface danger zone for small arms direct-fire weapons without explosive projectiles, *page 16*
- Figure 3–4: Cone surface danger zone for small- arms direct-fire weapons with explosive projectiles, *page 17*
- Figure 3–5: Batwing surface danger zone for small- arms direct-fire weapons with explosive projectiles, *page 17*
- Figure 3–6: Surface danger zone for indirect fire, mortars, *page 18*
- Figure 3–7: Surface danger zone for indirect fire, field artillery cannon, *page 18*
- Figure 3–8: Multiple surface danger zone; multiple fixed firing points and multiple fixed targets, *page 19*
- Figure 3–9: Multiple surface danger zone for single fixed firing point and multiple fixed targets, *page 19*
- Figure 3–10: Multiple surface danger zone with multiple fixed firing points and a single fixed target, *page 20*
- Figure 3–11: Multiple surface danger zone with multiple fixed firing points and multiple fixed or moving targets, *page 21*
- Figure 3–12: Movement box, multiple firing points, and fixed or moving targets, *page 22*
- Figure 3–13: Composite surface danger zone, *page 23*
- Figure 3–14: Basic weapon danger zone profile, *page 24*
- Figure 4–1: Cone surface danger zone for firing small arms direct-fire weapons without exploding projectiles, *page 26*
- Figure 4–2: Cone surface danger zone for firing small arms direct-fire weapons with exploding projectiles, *page 27*
- Figure 4–3: Batwing surface danger zone for firing small arms direct-fire weapons without exploding projectiles, except 5.56mm M1037 Short Range Training Ammunition, *page 28*
- Figure 4–4: Batwing surface danger zone for firing 5.56mm M1037 Short Range Training Ammunition, *page 29*
- Figure 4–5: Batwing surface danger zone for firing small arms direct-fire weapons with exploding projectiles, *page 30*
- Figure 4–6: Surface danger zone for M903, M962, MK211, and MK 211–0 .50 caliber ammunition, *page 31*
- Figure 4–7: Surface danger zone for .50 caliber M903 SLAP and M962 SLAP–T ammunition sabot discard area, *page 32*
- Figure 4–8: Surface danger zone for shotfall, *page 33*
- Figure 5–1: Surface danger zone for fragmentation and offensive hand grenades, *page 48*
- Figure 5–2: Surface danger zone for firing MK32, M79, M203, and M320 grenade launchers, *page 52*
- Figure 5–3: Surface danger zone for the MK19, MOD3 40mm grenade machine gun, *page 53*
- Figure 6–1: Surface danger zone for firing rocket launchers, *page 56*
- Figure 6–2: Surface danger zone, Area F, for firing rocket launchers, *page 57*
- Figure 6–3: Surface danger zone for firing multi- role anti-armor antipersonnel weapon systems, *page 59*
- Figure 6–4: Surface danger zone, Area F, for firing multi- role anti-armor antipersonnel weapon system, *page 60*
- Figure 6–5: Surface danger zone for firing AT4, *page 61*
- Figure 6–6: Surface danger zone, Area F, for firing AT4, *page 62*
- Figure 6–7: Surface danger zone for firing MK 80 SMAW–NE, *page 63*
- Figure 6–8: Surface danger zone for firing SMAW–HEAA, -HEDP, and common practice round, *page 64*
- Figure 6–9: Surface danger zone, Area F, for firing SMAW–NE, -HEAA, -HEDP, and common practice round, *page 65*
- Figure 7–1: Surface danger zone for firing basic TOW, practice TOW, ITOW, TOW 2A, TOW 2B, TOW 2B AERO, and TOW BB missiles, *page 69*
- Figure 7–2: Surface danger zone, Area F, for firing basic TOW, practice TOW, ITOW, TOW 2A, TOW 2B, TOW 2B AERO, and TOW BB missiles, *page 70*
- Figure 7–3: Surface danger zone adjustments for firing basic TOW, practice TOW, ITOW, TOW 2A, TOW 2B, TOW 2B AERO, and TOW BB missiles in a ground launch mode, *page 71*
- Figure 7–4: Area F for ATWESS and TOW missiles (Multiple Integrated Laser Engagement System training), *page 72*
- Figure 7–5: Surface danger zone for Javelin missiles, *page 75*
- Figure 7–6: Surface danger zone for Javelin Block 1 missiles, *page 76*

Contents—Continued

- Figure 7–7: Surface danger zone Area F, for Javelin missiles, *page 77*
- Figure 7–8: Primary danger area, Area F, extension for activation of the Javelin missile flight motor pressure relief system, *page 78*
- Figure 8–1: Surface danger zone for firing general tank cannon cartridges, *page 81*
- Figure 8–2: Surface danger zone for firing select tank cannon cartridges, *page 84*
- Figure 8–3: Surface danger zone for M865 and M1002 sabot petal discard hazard, *page 86*
- Figure 8–4: Flechette dispersion pattern for for M494 105mm, APERS–T, *page 88*
- Figure 8–5: Surface danger zone for firing 25mm and 30mm cannon cartridges, *page 90*
- Figure 8–6: Surface danger zone for fighting vehicle firing port weapon systems, *page 96*
- Figure 8–7: 25mm aluminum base Sabot discard hazard area, *page 97*
- Figure 8–8: 25mm plastic base Sabot discard hazard area, *page 98*
- Figure 8–9: 30mm discard hazard area, *page 99*
- Figure 8–10: Surface danger zones for firing L8A1/A3 smoke grenades, *page 101*
- Figure 8–11: Surface danger zones for firing grenades from M176, M226, and M239 grenade launchers, *page 102*
- Figure 8–12: Surface danger zones for firing M81 grenade using standard 66mm launchers on armored vehicles, *page 103*
- Figure 8–13: Surface danger zones for firing M82 grenades using standard 66mm launchers on armored vehicles, *page 104*
- Figure 8–14: Hazardous impulse noise 140 dBP contour zones, *page 106*
- Figure 9–1: Surface danger zone for firing mortars, *page 109*
- Figure 10–1: Surface danger zone for firing field artillery cannon or Expeditionary Fire Support System 120mm (rifled) mortar in the indirect mode at ground, fixed, or moving targets, *page 114*
- Figure 10–2: Surface danger zone for firing field artillery cannon in the direct mode at ground, fixed, or moving targets, *page 115*
- Figure 10–3: Surface danger zone for firing field artillery cannon with antipersonnel ammunition in the direct mode at fixed or moving targets, *page 116*
- Figure 10–4: Surface danger zone for firing Copperhead projectiles in the ballistic mode, *page 118*
- Figure 10–5: Surface danger zone for firing Copperhead projectiles in the glide mode, *page 119*
- Figure 10–6: Flight corridor for field artillery cannon fire over aircraft, *page 121*
- Figure 10–7: An example of an established flight corridor, *page 122*
- Figure 10–8: Surface danger zone for firing Multiple Launch Rocket System/High Mobility Artillery Rocket System, *page 126*
- Figure 10–9: Area F for Multiple Launch Rocket System/High Mobility Artillery Rocket System, *page 127*
- Figure 10–10: Surface danger zone for firing Multiple Launch Rocket System/High Mobility Artillery Rocket Systems reduced range practice rocket point to point, *page 130*
- Figure 10–11: Surface danger zone for firing Multiple Launch Rocket System/High Mobility Artillery Rocket Systems reduced range practice rocket point-to-area, *page 131*
- Figure 10–12: Surface danger zone for firing Multiple Launch Rocket System/High Mobility Artillery Rocket Systems reduced range practice rocket operational area, *page 132*
- Figure 10–13: Area F for Multiple Launch Rocket System/High Mobility Artillery Rocket Systems reduced range practice rocket, *page 133*
- Figure 10–14: Area F for reduced range practice rocket operational area, *page 134*
- Figure 10–15: Formulas for determining risk during Multiple Launch Rocket System/High Mobility Artillery Rocket System reduced range practice rocket overhead fire, *page 135*
- Figure 11–1: Flanking fire restrictions, *page 140*
- Figure 11–2: Surface danger zone for firing aerial rocketry at ground targets Figure 11–2., *page 147*
- Figure 11–3: Area F, rear blast area for hover firing and loading or unloading aerial rockets, *page 148*
- Figure 11–4: Directed fire surface danger zone for firing AGM–114 A/F HELLFIRE laser-guided missiles in direct launch at fixed target (Lock-On-After-Launch autonomous or Lock-On-Before-Launch with remote designation), *page 149*
- Figure 11–5: Indirect fire weapons danger zone/surface danger zone for firing AGM–114 A/F HELLFIRE laser-guided missile in the indirect launch mode with remote designation) at fixed target or firing the AGM–114 K/N missile in either the direct or indirect launch mode, *page 150*
- Figure 11–6: Expanded direct weapons danger zone/surface danger zone (Army RW only) for firing AGM–114 A/F HELLFIRE laser-guided missile with associated missile tip-off error in direct launch mode at fixed target (Lock-On-After-Launch autonomous or Lock-On-Before-Launch with remote designation), *page 151*

Contents—Continued

- Figure 11-7: Expanded indirect weapons danger zone/surface danger zone for firing AGM-114 A/F HELLFIRE laser-guided missile with associated tip-off error in the indirect launch mode (Lock-On-After-Launch with remote designation) at fixed target or firing the AGM 114-K/N missile with associated tip-off error in either the direct or indirect launch mode, *page 152*
- Figure 11-8: Designator zones for use with AGM-114 HELLFIRE laser-guided missile surface danger zone, *page 153*
- Figure 11-9: Maximum designation angle for AGM-114 HELLFIRE missile laser designators, *page 154*
- Figure 12-1: Surface danger zone for firing Redeye guided missile at moving targets, *page 157*
- Figure 12-2: Surface danger zone for firing Stinger guided missiles at moving targets, *page 158*
- Figure 12-3: Surface danger zone, Area F, for firing Stinger guided missile, *page 159*
- Figure 12-4: Surface danger zone for firing Chaparral guided missiles at a point in space, *page 160*
- Figure 12-5: Surface danger zone for firing PATRIOT missiles, *page 162*
- Figure 12-6: Surface danger zone for Improved Hawk guided missile firing at a point in space, *page 163*
- Figure 12-7: Typical trajectory corridor, *page 164*
- Figure 14-1: Surface danger zone for 12- gauge M1012 (AA51) and M1013 (AA52), *page 170*
- Figure 14-2: Surface danger zone for M1006 (BA06) 40mm sponge grenade, *page 171*
- Figure 14-3: Surface danger zone for the 40mm grenade foam rubber baton (BA07), rubber ball grenade (BA08), and M1029 (BA13), *page 172*
- Figure 14-4: Surface danger zone for rubber ball grenade (GG04) (Hand Thrown), *page 173*
- Figure 14-5: Surface danger zone for rubber ball grenade (GG04) (Shotgun Launched Grenade), *page 174*
- Figure 14-6: Surface danger zone for modular crowd control munition (WA97), *page 175*
- Figure 14-7: Surface danger zone for M84 stun grenade (GG09), *page 176*
- Figure 14-8: Surface danger zone for M98 (FZ16), and M99 (FZ17) 66mm non-lethal grenade, *page 177*
- Figure 14-9: Launched electrode stun device, *page 178*
- Figure 14-10: Surface danger zone for the non-lethal bursting hand grenade (M104), *page 179*
- Figure 14-11: Surface danger zone for the non-lethal/tube launched munition system, *page 181*
- Figure 15-1: Surface danger zone for firing a mine-clearing line charge with the M58 HE charge, *page 187*
- Figure 15-2: Surface danger zone for firing mine-clearing line charge with the M68 inert charge, *page 188*
- Figure 15-3: Surface danger zone for firing the Anti-Personnel Obstacle Breaching System, *page 189*
- Figure 15-4: Surface danger zone for firing Claymore mines, *page 191*
- Figure 15-5: Surface danger zone for Air Volcano anti-personnel multiple delivery mine system, *page 192*
- Figure 15-6: Surface danger zone for Air Volcano Anti-Tank multiple delivery mine system, *page 193*
- Figure 15-7: Surface danger zone for M87/M87A1 Ground Volcano multiple delivery mine system, *page 194*
- Figure 15-8: Surface danger zone for M88 Ground Volcano multiple delivery mine system, *page 195*
- Figure 15-9: Surface danger zone for M2/M4A1 Selectable Lightweight Attack Munition and M3 Demolition Attack Munition, *page 199*
- Figure 15-10: Surface danger zone for the Rifle Launched Entry Munition and Grenade Rifle Entry Munition, *page 200*

Glossary

Chapter 1 Introduction

1-1. Purpose

This pamphlet provides minimum requirements for the U.S. Army and Marine Corps Range Safety Programs prescribed in Army Regulation (AR) 385-63 and Marine Corps Order (MCO) 3570.1C. It also establishes standards and procedures for the safe firing of ammunition, demolitions, lasers, guided missiles, and rockets, and the delivery of bombs for training, target practice, and to the extent practicable, combat.

1-2. References

Required and related publications and prescribed and referenced forms are listed in appendix A.

1-3. Explanation of abbreviations and terms

Abbreviations and special terms used in this pamphlet are explained in the glossary.

1-4. Deviations

a. Deviations from range standards or procedures contained in AR 385-63/MCO 3570.1C and this document may be granted based on critical mission requirements. Risk management will be integrated into the deviation process. Deviations are limited to—

(1) Reducing surface danger zone (SDZ), laser surface danger zone (LSDZ), and weapon danger zone (WDZ) dimensions when terrain, artificial barriers, or other compensating factors make smaller danger zones safe.

(*a*) Deviations applied to danger zones extending beyond authorized range impact area(s)/installation boundaries must be based on the ability to sufficiently contain projectiles, hazardous fragments, laser beams, and both vertical and horizontal ricochets within the authorized range impact area(s)/installation boundaries and areas under military control (for example, leased land or training areas acquired through memorandum of agreement or memorandum of understanding).

(*b*) For the Marine Corps, deviations for danger zones extending beyond the installation boundaries must be validated by Commanding General (CG), Training Education Command, Range and Training Area Management (RTAM) Branch, Marine Corps Combat Development Command (MCCDC), 3300 Russell Road, Quantico, VA 22134-5001 using the Probabilistic SDZ Tool.

(2) Modifying prescribed procedures for a munitions' use appropriate for a state of training of participating personnel to increase training realism.

(3) Allowing personnel not authorized by chapter 3 of this pamphlet within the danger zone, unless prohibited.

b. At a minimum, all deviation authorizations will contain the following, as appropriate:

(1) Statement citing chapter, paragraph, and subparagraph of the specific condition requiring deviation, and the name and number of the operational range, training facility, or maneuver area involved.

(2) Description of the existing condition and anticipated hazards, subsequent hazard analysis, and risk analysis.

(3) Statement as to why a deviation is necessary and impact on training if not granted.

(4) Control measures taken to mitigate hazards and/or minimize risk and residual risk level.

(5) Installation and unit standard operating procedures (SOPs) governing the specific operational range, training facility, or maneuver area for which the deviation applies.

(6) Scaled topographical map depicting SDZ and requested deviation.

(7) Map coordinates of the firing position(s), target location, and quadrant or elevation of fire, if required. The firing position(s), direction of fire, and danger zones will be plotted on the scaled map with distances shown in meters (m).

(8) Computer-generated danger zones and terrain profiles created using the Range Managers Toolkit (RMTK) may be submitted with deviation requests in lieu of developing them through manual means, if deemed appropriate by the senior commander (Army)/installation commander (Marine Corps). These computer-generated danger zones and terrain profiles must be developed using the current approved version of the RMTK. Danger zones and terrain profiles must depict the gun target line (GTL), the left and right limits of fire, the relative elevation of the weapon system being fired, the target, and the natural terrain backstop or artificial barrier, as appropriate. Risk-management principles will be applied in determining if alternate danger zones are applicable.

c. Requests for deviation shall originate from the unit or activity conducting the event or the installation Range Management Authority (RMA) (Army), Range Control Officer (RCO) (Marine Corps). The installation RMA (Army), RCO (Marine Corps) makes the initial judgment regarding the suitability of a proposed deviation prior to submission to the approving authority. Requests will be coordinated through the appropriate chain of command. For the Army, coordination will include both garrison and mission safety offices, legal review, environmental, and public affairs offices, as appropriate.

d. Deviations are valid for 1 year or less.

e. Deviations shall not be applied to other Federal agency directives, such as airspace or water traffic requirements.

f. Army commands (ACOMs), Army Service component commands (ASCCs), and direct reporting units (DRUs)

communicate directly with the U.S. Army Training and Doctrine Command (TRADOC) Capability Manager - Ranges (TCM Ranges) for technical information and guidance on risk management. Marine Corps organizations may communicate directly with Training and Education Command, RTAM Division (C465) for technical information and guidance.

1–5. Requirements for range safety certification programs

a. Range safety certification programs will be used to train and qualify personnel in the duties of Officer In Charge (OIC) and Range Safety Officer (RSO) for firing exercises and maneuver operations. Army certification programs are normally conducted at the unit level in accordance with an established range safety certification program. Marine Corps OIC and RSO certifications will be conducted at the installation level only. Prior to attendance, Marine Corps personnel must complete the Range Safety (Basic) Distance Learning Course. The Marine Corps certificate is valid for 3 years. Government civilian personnel may serve as OIC or RSO per the guidance in table 1–1. Contractors may serve as RSO, but in accordance with Department of Defense Instruction (DODI) 1100.22 and Federal Acquisition Regulations Subpart 7.5, contractors may not serve as OIC.

b. Range safety certification programs will be integrated into organizational training.

c. Once satisfied through training and testing that individuals are qualified to perform the duties of OIC and RSO of the firing unit, battalion/squadron commanders will forward their names to range operations (Army), range control (Marine Corps) for appropriate action.

d. The RMA (Army), RCO (Marine Corps) will provide personnel designated as OICs and RSOs a range safety briefing on the use of the training complex as part of certification.

e. The installation RMA (Army), RCO (Marine Corps) and the garrison/mission safety staff (Army) will monitor the effectiveness of range safety certification programs for OICs and RSOs.

f. For the Army, a locally devised "Range Safety Card" program may be employed in lieu of unit-generated rosters of certified personnel if approved by the senior commander.

g. The senior commander (Army)/installation commander (Marine Corps) may reduce the OIC and RSO grade requirements in table 1–1 by not more than one grade, with the following exceptions:

(1) The OIC of battalion or larger combined arms live-fire exercise ((CALFEX) Army)/combined arms exercise ((CAX) Marine Corps) will be a field grade commissioned officer. Exercise RSO of battalion or larger CALFEX/CAX will be an E–7 or above.

(2) Marine Corps explosive ordnance disposal (EOD) units are exempt from OIC and RSO requirements when conducting EOD proficiency training on a Department of Defense Explosives Safety Board (DDESB) sited range. However, when EOD units are conducting operational training on any operational training range the OIC/RSO requirements in table 1–1 apply. EOD units conducting EOD operations will supervise demolition and disposal operations following the guidance contained in NAVSEA OP 5, NAVSEA SWO60–AA–MMA–010, and Explosive Ordnance Disposal Bulletin (EODB)/Technical Manual (TM) 60–series publications. Marine Corps EOD units conducting disassembly and inerting will assign a qualified EOD technician as an RSO. Commanding officers may designate in non-emergency SOPs other instances that require EOD units to use an RSO. The RSO may be an E–5 or above if they are currently qualified as an EOD officer or technician military occupational specialty (MOS) 2305/2336.

**Table 1–1
Officer In Charge and Range Safety Officer appointment requirements**

Weapon system	OIC ¹			RSO ¹		
	Officer	Warrant officer (WO)	Noncommissioned officer (NCO)	Officer	WO	NCO
Practice hand grenades; sub-caliber training devices; laser devices; firing devices; simulators and trip flares; small arms and machine guns.	X	X	E–6	X	X	E–5
Chemical agents and smoke ²	X	X	E–6	X	X	E–5
Aerial gunnery and air defense weapons; live grenades, grenade launchers, and grenade machine guns; live mines and demolitions; tank and fighting vehicle cannons.	X	X	E–7	X	X	E–6
Field artillery ³	X	X	E–7	X	X	E–6
Mortars	X	X	E–6	X	X	E–6 ⁴

**Table 1-1
Officer In Charge and Range Safety Officer appointment requirements—Continued**

Air defense artillery rockets and guided missiles	X	X		X	X ⁵	
Direct fire antitank rockets and missiles	X	X	E-7	X	X	E-6
Live-fire exercises using organic weapons, squad through company, battery, troop.	X	X	E-7	X	X	E-6
CALFEX/CAX using outside fire support, troop, battery, squad, platoon, company; or battalion and larger. ⁶	X	X	E-7	X	X	E-6

Notes:

¹ Civilians in the grade of general schedule (GS)-07 and above, or equivalent, may act as OIC; GS-05 and above, or equivalent, may act as RSO.

² For the Marine Corps, OIC and RSO must be E-4 and above and be chemical, biological, radiological, and nuclear (CBRN) MOS 5702/5711 when conducting CBRN or smoke training. For the Army, OIC and RSO must be CBRN qualified when conducting CBRN or smoke training.

³ Use of E-7s as OICs is authorized only when approved by the senior commander (Army)/installation commander (Marine Corps). Duties of the RSO are normally performed by either the battery executive officer or the platoon leader.

⁴ RSO for Marine Corps can be an E-5 for mortar training activities.

⁵ Senior Range Safety Officer (SRSO) will be a chief warrant officer four or higher, or a civilian in the grade of GS-12 or above.

⁶ For battalion or larger CALFEX/CAX, OIC will be a field grade commissioned officer; exercise RSO will be E-7 or above.

Chapter 2 Ranges

2-1. Restricting access to and activities on impact areas

a. Unauthorized persons are prohibited from entering the installation training complex. When empowered, the installation RMA (Army), RCO (Marine Corps) is the approval authority for entry onto ranges and maneuver areas, and into any impact area - temporary, dedicated, or high hazard.

b. Unauthorized persons are prohibited from entering impact areas and other areas known or suspected to contain unexploded ordnance (UXO) by use of positive controls to include fencing and/or posting of UXO hazard warning signs. Commanders will ensure appropriate measures are used to restrict access to areas known or suspected to contain UXO. The commander will use risk management to determine the type and extent of marking and/or fencing required. Primary factors to consider in making this risk decision are accessibility of the public to restricted locations and the level of UXO hazards in the area.

c. Where practical, positive means of excluding livestock (such as fences or gates) must be established unless a written agreement negating this requirement is in effect with livestock owners.

d. The installation RMA (Army), RCO (Marine Corps), a designated representative, and/or EOD personnel will brief personnel, who have an operational requirement and are authorized access to an operational range's impact area, on the hazards associated with UXO and other hazards.

e. Access into temporary and/or dedicated impact areas will be strictly controlled. Those portions of temporary and dedicated impact areas authorized for training or other authorized purposes will be surface cleared of UXO before access is permitted. Cleared areas that become contaminated during live-fire exercises will be cleared when the exercise has been completed. Firing munitions into a UXO contaminated area for the purpose of clearing the area of UXO is not authorized. Training events that include firing mine clearing line charges or other similar munitions are not considered UXO clearing activities. Controlled burn activities to reduce ground cover to mitigate risks prior to a surface-clearing operation or contamination survey must be coordinated with appropriate installation staff offices. Fire will not be used to clear UXO.

f. Access to high-hazard impact areas will be limited to qualified EOD personnel, range operations (Army), range control (Marine Corps), range maintenance, and safety personnel designated by the installation RMA (Army), RCO (Marine Corps).

g. High-hazard impact areas that have improved conventional munition (ICM) or sub-munition duds are permanently contaminated and will not be cleared by Army personnel or entered by Army range personnel for range maintenance. Marine Corps EOD personnel and supporting Marine Corps personnel of any MOS are authorized access into ICM-contaminated impact areas to conduct range clearance operations and MOS proficiency training. Marine Corps EOD personnel will accompany supporting personnel at all times while in the ICM contaminated area.

h. Entry into high explosive (HE) dud contaminated areas to extinguish fires may be an extremely high-risk operation that requires a thorough risk assessment and approval at the appropriate level of command.

i. Digging entrenchments, foxholes, slit trenches, or any other activities that disturbs earth within an impact area is not permitted unless authorized by the installation RMA (Army), RCO (Marine Corps). Maneuvers within a temporary

impact area that include bivouac must prevent disturbing earth by driving poles, pegs, and so forth into the ground, trenching around tents, or any activity that could disturb a UXO located just beneath the ground surface. Open fires will not be permitted.

j. Unauthorized personnel are prohibited from handling UXO and munitions or removing them from the training complex. Procedures (for example, amnesty boxes) will be established for turn-in of ammunition and explosives (AE) items.

k. All normal vehicular and foot traffic approaches to ranges and impact areas will be guarded by range guards, properly instructed in their duties, or closed off by appropriate barriers, as determined by the installation RMA (Army), RCO (Marine Corps). When barriers are used, appropriate signs will be posted.

l. Aeronautical charts limit aerial access to ranges within restricted areas.

2-2. Posting warning signs, markers, and flags

a. Warning signs should comply with Section 200, Part 1926, Title 29, Code of Federal Regulations (29 CFR 1926) and DA Pam 385-11. Such signage should include a signal word (such as "Danger" or "Warning"), safety symbols that identify the hazard and hazard avoidance (such as a pictogram of an explosion and "Do Not Enter" symbol), and a text message (such as "Explosive Hazard, Keep Out") (refer to DA Pam 385-11). (Note: New signage, if constructed locally, shall be at least 33 centimeters (cm) by 43.5cm in overall size and of weather-resistant materials.) The sign will state "UNEXPLODED ORDNANCE - DO NOT ENTER" in two lines of red, sans-serif capital letters in the lower white section of the sign. Lettering will be at least 5cm high and of weather-resistant materials or as dictated by the host nation. Warning signs will be posted around the installation training complex to warn and prohibit entry by unauthorized persons, and to alert authorized personnel entering a hazard area (see fig 2-1).



Figure 2-1. Sample warning signs

b. Signs at entry points to the training complex will prohibit trespassing and removal of items under penalties provided by law. Signs will also emphasize the dangers associated with unlawful entry and handling of dud ammunition. Where appropriate, signs will be in both English and the applicable foreign language.

c. Warning signs will be placed to ensure they are visible to individuals attempting to enter training complex live-fire areas at any point around its perimeter. They will be placed at 200 m intervals or less, if practicable, or in a way that will ensure that a person cannot enter the range without seeing at least one sign within a legible distance.

d. Commanders will ensure UXO hazard signs are posted at a maximum of 200 m intervals around all UXO locations.

e. Safety (danger, warning, caution) signs and signals will be used to warn personnel approaching a firing area. Scarlet danger flags supplemented by blinking red lights at night or during reduced visibility will be displayed from a prominent point, normally at the range entrance.

f. Signs warning personnel of the danger from projectiles, bombs, lasers, and UXO will be posted near the firing area at all times.

g. Internal and external limit of fire markers will be placed to denote right and left limits of fire. For the Army, internal and external limit of fire markers will be placed on direct-fire ranges only. See Training Circular (TC) 25–8 for limit-of-fire design requirements. When required, limit-of-fire markers shall be illuminated to ensure proper target area identification at times of limited visibility. Limit-of-fire markers should be thermalized when thermal weapons sights are used. In accordance with DA Pam 385–11, appropriate hearing protection, eye protection, and laser warning signs will be posted at each range and firing line.

h. Individual vehicles, tanks, fighting vehicles, and armored personnel carriers may display flags to show the vehicle's weapon status in accordance with the appropriate field manual. See paragraph 8–4 for more information.

2–3. Controlling other range usage

a. When the installation training complex is authorized for use by non-military organizations such as schools; county, municipal, State, or Federal agencies; organized clubs (including rod and gun clubs) or civic associations, the following requirements apply:

(1) The organization or agency will comply with requirements and procedures established by AR 385–63/MCO 3570.1C, this pamphlet, and local range regulations and SOPs.

(2) Requests for use will be coordinated with the installation RMA (Army), RCO (Marine Corps), appropriate safety office(s), and the Judge Advocate General; and submitted to the senior commander (Army)/installation commander (Marine Corps) for approval.

(3) Requests will identify if non-DOD associated minors will be involved in live-fire activities. If so, the activity must be an approved course of marksmanship training, unless otherwise approved by the senior commander (Army)/installation commander (Marine Corps).

(4) A written agreement must be completed between the installation and the non-military organization, detailing all rights and responsibilities of each party, liabilities, procedures, and regulatory and procedural requirements. For the Army, this agreement will be incorporated into the report of availability as required by AR 405–80.

(5) The non-military organization will designate an OIC and RSO. Personnel designated as OICs and RSOs will complete a pistol and rifle course approved by the National Rifle Association, or equivalent (for example, U.S. Pistol Shooters Association). The senior commander (Army)/installation commander (Marine Corps), based on input from the RMA (Army), RCO (Marine Corps), garrison safety office, Judge Advocate General, and other staff agencies, as appropriate, will determine the equivalency. For the Marine Corps, OICs and RSOs must complete the Range Safety (Basic) Distance Learning Course.

(6) The installation RMA (Army), RCO (Marine Corps) will ensure designated OICs and RSOs are briefed on their duties and responsibilities.

b. Military Family members engaging in authorized live-fire activities such as marksmanship training or participating in activities involving weapons firing, such as organizational or Family days, will comply with this pamphlet, installation range regulations, and SOPs. Requests for these activities will specify if minors will be involved. Unit will maintain a roster of all Family members for tracking and identification purposes.

c. Civilian personnel, such as military Family members and local populace, must receive authorization from the installation RMA (Army), RCO (Marine Corps) to enter the training complex to participate in or observe capabilities exercises, fire power demonstrations, training courses, competitions, or other types of live-fire exercises. Such personnel will remain in designated safe areas as determined by the installation RMA (Army), RCO (Marine Corps).

d. Inspection team members or other official observers required to be on the firing line, firing position, or firing area will position themselves in safe areas as determined by the installation RMA (Army), RCO (Marine Corps). These personnel must wear appropriate safety equipment as specified by the local range regulations and the installation RMA (Army), RCO (Marine Corps).

e. Civilians, to include Family members and DOD civilians, must have approval from the installation RMA (Army), RCO (Marine Corps) to fire weapons within the installation training complex.

2–4. Coordinating use of special use airspace

a. *Hazardous activities.* Any activity considered hazardous to nonparticipating aircraft or requiring special use airspace (SUA) to segregate it from other users of the National Airspace System or in the airspace of host countries will not be conducted until appropriate SUA has been designated and activated for that purpose.

b. *Types of activities that may require special use airspace.* Types of activities that may require SUA include, but are not limited to: artillery fire, mortars, missiles and rockets, air-to-ground and ground-to-air weapon systems, aerial target practice, laser operations, demolition and explosive devices, electronic warfare devices, remotely piloted and unmanned aerial systems, conducting hazardous activities, small arms ranges and any other activity considered to be hazardous or non-compatible with other users of the airspace. SUA is required to be designated and activated prior to conducting any activity over 45 m (150 feet (ft)) above ground level (AGL) (to include ricochet ordinates) that would be hazardous to aircraft. When determining requirements for and type of new SUA to support planned training, a risk assessment will be performed that identifies the degree of risk posed by hazards to existing airspace users from planned live-fire events.

c. Installation Range Management Authority (Army), Range Control Officers (Marine Corps) special use airspace. The installation's RMA (Army), RCO (Marine Corps) shall be involved in all SUA matters. For the Army, SUA will be established and managed in accordance with appropriate Federal Aviation Administration (FAA) regulations, applicable host nation rules and procedures, and AR 95-2. The installation air traffic and airspace (AT&A) officer is the focal point for SUA actions. For additional information and guidance, contact the appropriate ACOM, ASCC, DRU AT&A officer or Department of the Army representative (DAR). For the Marine Corps, SUA will be established and managed in accordance with appropriate FAA regulations or International Civil Aviation Organization rules, applicable host nation rules and procedures, OPNAVINST 3770.2K, MCO P3550.10, local SOPs, and range control procedures. All formal communications with the FAA must be in accordance with OPNAVINST 3770.2K.

d. Types of special use airspace. Types of SUA that may be established include, but are not limited to:

(1) *Restricted areas.* Airspace identified by an area on the surface of the earth within which the flight of aircraft, while not wholly prohibited, is subject to restrictions. Restricted areas will be designated when determined necessary to confine or segregate activities considered to be hazardous to nonparticipating aircraft. Examples of those activities include, but are not limited to, artillery, aerial gunnery, or guided missile firing.

(2) *Warning areas.* Airspace of defined dimensions that contains activity that may be hazardous to nonparticipating aircraft. The purpose of such warning areas is to warn nonparticipating pilots of the potential danger. A warning area may be located over domestic or international waters or both.

(3) *Military operations area.* Airspace of defined vertical and lateral limits established for the purpose of containing certain military training activities that include, but are not limited to, air combat tactics, air intercepts, acrobatics, formation flying, and low-altitude tactics in airspace as free as possible from nonparticipating aircraft.

(4) *Controlled firing area.* A controlled firing area (CFA) is established to contain activities that, if not conducted in a controlled environment, would be hazardous to nonparticipating aircraft. The distinguishing feature of a CFA, as compared to other SUA, is that its activities are suspended immediately when spotter aircraft, radar, or ground lookout positions indicate an aircraft might be approaching the area. Examples of CFAs are small arms or EOD ranges.

e. Display of special use airspace. SUA shall be shown on installation maps and overlays, as appropriate.

2-5. Small Arms Range Safety Area (Army)

For the Army, Small Arms Range Safety Areas (SARSAs) are areas the garrison commander establishes in the contiguous United States to contain small arms range activities that could be hazardous to non-participating aircraft. SARSAs are not SUA. Garrison commanders will ensure that users of Army small arms ranges that are located outside restricted airspace or CFAs follow the SARSA policy and procedures established below:

a. To protect aircraft, the garrison commander or designated representative (normally the installation range manager) will establish or abolish SARSAs at each small arms range not located within SUA as required by this pamphlet. Unless otherwise identified in this pamphlet, the data in tables 4-1 through 4-23, will be used as the basic vertical component for each weapon system used on the range. When determining SARSA altitude boundaries, 152 m (500 ft) will be added to that value and rounded up to the next 152-m increment of altitude as a safety buffer. Garrison commanders will take appropriate action to ensure that airspace above and adjacent to small arms ranges is adequately monitored to preclude endangering aircraft operations. Garrison commanders will also consider maximum ordinate (Max Ord) and highest altitude of fire where the specific range operations call for it.

b. The garrison commander or designated AT&A officer will coordinate with the appropriate senior commander's AT&A officer and DAR for development of SARSA proposals and letters of agreement (LOA) with local air traffic control (ATC) facility personnel to assist in the early detection and notification of approaching aircraft. Garrison commanders will coordinate SARSA proposals through Headquarters, U.S. Army Aeronautical Services Agency for areas not covered by the DAR. SARSA proposal requests will include—

- (1) Activity for which approval is being requested.
- (2) Specific location and boundaries.
- (3) Altitudes.
- (4) Name, address, and phone number of the originator of the request.
- (5) Proposed times of use.
- (6) Desired effective date.
- (7) Proposed safety precautions including visibility requirements, ceiling (cloud height) requirements, safety observers, communication links, and any other factors that enhance range safety.
- (8) Instructions, if applicable, for the installation range OIC to notify the owner or manager of airports that might be affected by the SARSA.

(9) Attachments: risk assessment, map with SDZ and 5 miles buffer depicted and ATC LOA (if applicable).

c. Upon receipt of SARSA proposal, the DAR:

- (1) Reviews the garrison commander's proposal to determine if the proposed SARSA presents conflict with the requirements of other airspace users.

(2) Encourages the proponent to explore the feasibility of conducting the activity in an existing restricted area where possible.

(3) Assists the AT&A officer in coordination with local ATC for LOA (if applicable) and reviews prior to signature.

(4) Prior to the establishment of the SARSA, reviews the proposal and informs the garrison commander of any recommendations by formal correspondence for proposal feasibility.

d. The following precautionary measures are mandatory requirements for all small arms ranges, as applicable:

(1) The ceiling (cloud height) will be at least 305 m (1000 ft) above the ricochet height. The garrison commander or their designated representative should also consider highest altitude of fire and Max Ord in addition to ricochet height as a part of risk assessment.

(2) Visibility will be sufficient to detect nonparticipating aircraft and then establish a cease fire before penetration of the aircraft into the SDZ.

(3) The garrison commander may elect, based on risk analysis, to substitute radar surveillance for the ceiling and visibility requirements. This provision is contingent on the adequacy and availability of the radar service and the necessary communication links to the range OIC.

e. The garrison commander or designated representative will establish procedures that designate a responsible officer (normally the range OIC) for the surveillance of the airspace in the SARSA. Safety observer(s) and radar should be able to monitor airspace inclusive of a border extending 5 miles from the boundaries of the SDZ of the SARSA. Safety observers will maintain positive, immediate communication with the range OIC or range operations firing desk (Army), range control (Marine Corps) at all times. Safety observers will be thoroughly briefed on their duties and responsibilities. Range operations (Army), range control (Marine Corps) must have an adequate plan in place to support the range OIC in this effort.

f. All firing activities within the SARSA must cease upon notification of impending or actual incursion of the SARSA by nonparticipating aircraft.

g. For assistance on SARSA matters, contact:

(1) Garrison commander's AT&A officer.

(2) Senior commander's AT&A officer.

(3) The DAR responsible for your geographic area (see AR 95-2, for DAR contact information).

(4) Headquarters, U.S. Army Aeronautical Services Agency.

2-6. Coordinating use of navigable waterways

a. U.S. Army Corps of Engineers (USACE) maintains notices of the restricted danger zones published in 33 CFR 334. USACE is the only entity authorized to waive water traffic requirements that apply to the live-fire of military munitions over navigable waters, to include inter-coastal waterways. Senior commanders (Army)/installation commanders (Marine Corps) will notify the USACE division or district commanders and the applicable U.S. Coast Guard District Office of—

(1) Waterway involved.

(2) Operations to be conducted.

(3) Sector of waterway needed for closure.

b. Federal laws that protect water traffic on navigable waterways authorize Secretary of the Army to prescribe regulations for use and navigation of waterways endangered or likely to be endangered by firings and target practice. USACE will publish a notice of the restricted danger zone under 33 CFR 334.

c. The senior commander (Army)/installation commander (Marine Corps) will not authorize firing until notice of the restricted danger zone is published in 33 CFR 334 and navigation maps have been revised. Additionally, the senior commander (Army)/installation commander (Marine Corps) will enforce closed waterways by radar and/or surface vessel surveillance. Firing will not commence until the U.S. Coast Guard has marked the restricted danger zone with buoys.

d. Military munitions containing phosphorous, including guided missiles or rockets, will not be fired or dropped into any inland waterway, lake, bay, wetlands, or other body of water.

e. Firing over navigable waters in overseas areas, to include inter-coastal waterways, will be performed within parameters of Status of Forces Agreements/Visiting Forces Agreements and appropriate host nation requirements.

2-7. Army safety requirements for indoor firing ranges and shoothouses

This paragraph provides Army requirements for the safe operation and maintenance of indoor firing ranges and shoothouses.

a. *Lead intoxication.*

(1) Indoor firing ranges and shoothouses must comply with Occupational Safety and Health Administration standards (29 CFR 1910.1025) including medical surveillance requirements. Personnel exposures, which are intermittent, will be controlled per the criteria provided in table 2-1.

(2) The criteria in table 2-1 were developed to control intermittent lead exposure and establish maximum hours of

exposure based on the airborne lead concentration and the number of days firing per year. These criteria are to be used as interim control measures only. Maximum effort will be made to reduce the airborne lead levels to 0.03 milligrams per cubic meter (mg/m³) or less.

(3) Lead exposures for personnel are determined by a sampling strategy that employs general-area and breathing-zone samples. Paragraph *b* contains guidance for air sampling. The Industrial Hygiene Department of the U.S. Army Public Health Command will conduct the airborne lead sampling and provide the analysis and recommend the maximum allowable hours of exposure to be used as indicated table 2–1. Once an airborne lead concentration is determined, table 2–1 is used to set maximum allowable hours of exposure for each category of range user. Other potential lead exposures, including off-duty firing, may contribute to an individual's overall exposure and should be considered in establishing maximum allowable exposure time.

(4) The command safety manager, RMA, industrial hygienist, and medical authority will make recommendations to the appropriate risk decision authority to determine the need for medical surveillance. Medical surveillance is not required for intermittent users if the maximum allowable exposure hours from table 2–1 are enforced.

b. Air sampling.

(1) Collect all lead samples on cellulose ester filters meeting the following specifications: pore size of 0.8 microns, 37 millimeters (mm) in diameter, three-piece preloaded cassette, and closed face. Sampling rate should be 1 to 4 liters per minute for a minimum volume of 500 liters.

(2) In indoor firing ranges, sample on the firing line, 3 m behind the firing line, and in adjacent areas (such as range office, supply room, or hallways). In small ranges (fewer than six firing positions), samples should be taken at each firing position on and off line. In larger ranges (six or more firing positions), breathing-zone and general-area samples should be taken in every other firing position and off line. In shoothouses, sample at each doorway and other locations where personnel may pause. Permanently assigned range personnel may be evaluated using data obtained from general-area and breathing-zone samples, if applicable. Take at least one air sample for lead in an area adjacent to the facility defined above during each monitoring period. The sample should indicate whether or not lead contamination is confined to the facility.

(3) The following actions are critical to proper evaluation:

(a) Sample during periods of maximum use.

(b) If firing is over an extended period of time, allow time for possible buildup of airborne concentrations before sampling.

(c) Sample during the use of higher-caliber ammunition if more than one type of ammunition is used.

(4) Calibrate all pumps before and after use by a method traceable to a primary standard (for example, bubble and burette).

c. Ventilation.

(1) Contaminations occur as byproducts of firing (that is, lead, carbon monoxide, and aldehydes) and must be removed from the facility through an adequate ventilation system. The maximum concentration of lead acceptable for an 8-hour daily exposure (time-weighted average) is 0.05 mg/m³. A ventilation system designed to provide this protection is sufficient to remove other byproducts of firing.

(2) Optimum ventilation systems should intake make-up air behind the firing line and expel exhausted air at the target line or bullet trap.

(3) Downrange air velocity can be measured or approximated by using a 30-second smoke candle and stop watch. Ignite the smoke candle behind the firing line and time the smoke from the moment the first plume crosses the firing line until it reaches the bullet trap. Calculate the air velocity in meters per second (m/s) by dividing the range distance or length (from firing line to bullet trap) (D) by time (T), or $D/T = m/s$. A minimum of 0.18 m/s is required. This is equal to 0.017 cubic meters per second per square meter of cross-sectional area. During the smoke evaluation, observe the range for any "dead spots" (swirling of smoke up-range) or other turbulent airflow motions that may allow for increased exposure at or behind the firing line.

(4) Ensure proper disposal of contaminated waste (for example, filters).

d. Army requirements for inspection of indoor firing ranges and shoothouses. These facilities require periodic inspections to ensure compliance with current health and safety standards. The types of periodic inspections are initial, detailed, and annual.

(1) Initial inspections are one-time inspections made by qualified and competent safety or engineer personnel. The purpose of the initial inspection is to classify the authorized level of use of the facility. Based on the findings of the initial inspection, the facility will be classified as safe, limited, or unsafe. DA Form 5687 (Initial Inspection Checklist for Indoor Ranges) will be used to record the initial indoor firing range inspection. Criteria for initial inspection of shoothouses will be developed by the RMA, appropriate safety office, industrial hygiene office, and appropriate medical authority based on local conditions. A copy of the initial inspection will be maintained at the range and available for review.

(a) A facility classified as safe permits authorized firing for military and civilian use.

(b) A facility classified as limited permits only limited use under controlled conditions. The personnel exposure limits for intermittent atmospheric lead exposure will be used for limited operation of the facility.

(c) A facility classified as unsafe is not authorized for use under any conditions.

(2) Detailed inspections will be made by the support installation team composed of safety, facility engineer, and medical department activity representatives. Detailed inspections are in addition to the initial inspection. DA Form 5688 (Detailed Inspection Checklist for Indoor Ranges) will be used as a minimum for conducting the indoor firing range inspection. Criteria for detailed inspection of shoothouses will be developed locally as in paragraph (1), above. Findings from the detailed inspection will determine complete facility retrofit requirements. For new facilities, a detailed inspection will be made within 120 days of the initial inspection. It is important that appropriate safety, industrial hygienist and range authority representatives participate in the planning, preparation and execution stages of design and construction of all ranges.

(3) Annual inspections will be made by safety specialist (0018 series) or safety engineer (0803 series) personnel to ensure safety standards and procedures are maintained in the operation of the facility. The annual inspection will be made within 45 days of the anniversary date of the last annual inspection.

e. Disposition. of Army inspection and evaluation results.

(1) Inspection and evaluation results will be provided to the next higher headquarters for action as appropriate. Supporting installation safety managers will maintain an information copy.

(2) The supporting facility coordinator will maintain a record of each inspection. Subsequent inspections will be made as a follow-up check against previous inspection results to assure required corrective action(s) noted has/have been accomplished and that there are not adverse changes to the building envelope, environmental conditions, and/or safe operating procedures.

f. ACOMs, ASCCs, and DRUs may address inquiries pertaining to indoor range safety to Commanding General, U.S. Army Training and Doctrine Command, TRADOC Capability Manager (TCM) Ranges (ATIC-LTR-O), Fort Eustis, VA 23604-5700.

g. Inquiries. pertaining to ventilation, air sampling and other industrial hygiene issues should be directed to Commander, U.S. Army Public Health Command (MCHB-IP-OFS), 5158 Blackhawk Road, Aberdeen Proving Ground, MD 21010-5403.

**Table 2-1
Breathing zone exposure limits for intermittent atmospheric lead exposures (Army)**

Concentrations (in mg/m ³) ¹	Maximum hours of allowable exposure per day		
	Soldiers exposed fewer than 30 days per year	Soldiers in marksmanship teams or soldiers exposed more than 30 days per year and all nonmilitary personnel	Range users under 17 years of age
0.000 to 0.029	8	8	4
0.030 to 0.039	8	6	3
0.040 to 0.049	8	4.5	2
Limited-use ranges			
0.050 to 0.059	6.5	4	2
0.060 to 0.079	5	3	1
0.080 to 0.099	4	2.25	1
0.100 to 0.149	2.5	1.6	0
0.150 to 0.199	2	1.2	0
0.200 to 0.299	1.25	.75	0
0.300 to 0.399	1	0.6	0
0.400 to 0.499	0.75	0.45	0
0.500 to 0.749	.5	0.3	0
0.750 to 0.999	0.35	0.24	0
1.000 or above	0	0	0

Notes:

¹ These values are the actual concentrations measured over the sampling period and are not 8-hour, time-weighted averages.

2-8. Marine Corps safety requirements for indoor firing ranges

This paragraph provides Marine Corps requirements for the safe operation and maintenance of indoor firing ranges.

- a. Indoor firing ranges will comply with the information listed within Military Handbook (MIL-HDBK) 1027/3B and NEHC-TM 6290.99-10.
- b. Marine Corps inquiries regarding indoor firing ranges will be directed to Commanding General, Training Education Command, Range and Training Area Management Branch, Marine Corps Combat Development Command (MCCDC), 3300 Russell Road, Quantico, VA 22134-5001.
- c. Indoor firing ranges will be certified and recertified per MCO 3550.9.

2-9. Recreational ranges

a. Procedures in this pamphlet apply to recreational ranges located on Government property. Recreational activity on ranges must be approved by the installation commander on a case by case basis. Formal memorandums of agreement must be established with approved organizations participating in recreational range activity. Memorandums of agreement at a minimum must address the following:

- (1) Liability for both safety and environmental National Environment Protection Action compliance.
- (2) Emergency response requirements and responsibilities.
- (3) Responsibilities for maintenance and best management practices of the range.
- (4) Operating cost and consumables.

b. Archery target ranges will follow range designs included in the USACE Drawings (Planning and Design of Outdoor Sports Facilities) file number 750-90-01. Other designs including 3-dimensional archery ranges or field ranges simulating hunting scenarios must have a positive backstop. Additional guidance is available from the National Field Archery Association.

c. Shotgun (skeet/trap) ranges will follow range designs included in the USACE Drawings (Planning and Design of Outdoor Sports Facilities) file number 750-90-01. The shotfall danger zone will be a minimum of 275 m (300 yards) as per 750-90-01 and the ranges must be limited to shot sizes 7.5, 8, 8.5, and 9 shot. Additional guidance is available from the National Skeet Shooting Association, and the National Sporting Clays Association. Military training used for shotgun firing (not on a recreational skeet/trap range) will be in accordance with SDZ requirements in chapter 4. Marine Corps shotgun ranges will be certified in accordance with MCO 3550.9.

2-10. Ammunition and explosive items on ranges

Procedures for transporting, storage, handling, and security of AE items are contained in DA Pam 385-64 or NAVSEA OP5 or in applicable field manuals (FMs) or technical manuals (TMs). In addition, the following instructions, with relevant references, pertain to operational ranges:

a. *Positioning and issuing of ammunition and explosive.* Positioning and issuing of AE, to include quantity-distance determinations, will be in accordance with DA Pam 385-64 or NAVSEA OP5, Volume 1. The RMTK may be used to plan for positioning and issuing of AE on operational ranges.

(1) Operational ranges require AE at various locations (for example, firing points) that are inherent to a training exercise or temporary or transient by nature. These locations do not require a site plan approved by the DDESB. However, permanent structures on ranges used for administrative storage or issuance of AE must be sited and approved by the U.S. Army Technical Center for Explosives Safety and subsequently by the DDESB.

(2) Distribution of AE to personnel will occur only in areas designated for that purpose, for example, ready lines, firing lines, attack positions, assembly areas, or defilade positions. Blank and live-fire AE will not be stored in or issued from the same location at the same time.

(a) Fuel storage areas will be located at separation distances from ammunition storage areas based on the amount of fuel.

1. Fuel quantities up to 500 gallons will be separated from each potential explosion site by at least 50 ft.

2. Fuel quantities between 500 to 5,000 gallons will be separated from each potential explosion site by at least 100 ft. U.S. Army ACOMs, ASCCs, and DRUs may address inquiries pertaining to indoor range safety to Commanding General, U.S. Army Training and Doctrine Command, TRADOC Capability Manager (TCM) Ranges (ATIC-LTR-O), Fort Eustis, VA 23604-5700.

3. For fuel quantities greater than 5,000 gallons, refer to DA Pam 385-64 (Army) or NAVSEA OP5 (Marine Corps).

(b) Forward arming and refueling point operations, and separation distances for fuel, ready ammunition storage areas, and basic load storage areas will be in accordance with FM 3-04.111, FM 10-67-1, and Naval Air Systems Command (NAVAIR) 00-80T-109.

1. The quantity of ammunition unpacked for training will be kept to the minimum quantity needed for live-fire training or an exercise. Packaging material, propelling increments, and fuzes will be retained until completion of the live-fire portion of the training or exercise. Units will not burn wooden containers or indiscriminately use or dispose of ammunition to preclude its return to a storage facility. (Exception: GTR-18 Smokey Sam rockets are issued by the case with a quantity of 12 rockets and 12 igniter rods. Planning use of these pyrotechnics requires careful consideration of

the effects of moisture on unpacked items. All unpacked rockets must be expended and only full, unbroken cases returned to the ammunition supply point (ASP.) Broken and/or unserviceable increments (powder bags) will be handled in accordance with installation range SOPs.

2. Guided missiles, rockets and components, such as fuels, propellants, oxidizers, and explosives in ready storage or at the firing location will be positioned to minimize the possibility of ignition or detonation by motor exhaust or by an accident involving the firing of a missile or rocket. Such military munitions will be stored in dry locations, protected from direct rays of the sun, and adequately ventilated. Marine Corps Smokey Sams, Smokey Guns, and pyrotechnics will be stored as outlined in appropriate Marine Corps TMs, or NAVAIR technical publications.

3. During pre-fire preparation, guided missiles, rockets, and components will be handled and assembled in a manner consistent with this pamphlet, local range SOPs, and appropriate FM and TM. Any alteration to guided missiles or rockets and their associated equipment is prohibited except as authorized by official publications or by CG, Army Materiel Command (AMC).

4. All AE, unpacked for use but not used, will be repackaged into its original packing configuration prior to return to the ASP. AE that is easily degraded by short-term exposure to moisture, such as propelling charges, pyrotechnic signals, and simulators, will be unpacked only for the minimum amount of time consistent with mission requirements.

(c) Requests for current status of AE not listed in Naval Supply Systems Command (NAVSUP) P-801 will be sent to Navy Operational Logistics Support Center (NOLSC) Mechanicsburg, PA, Defense Switched Network 430-2107/commercial (717) 605-2107 (Marine Corps).

(d) Defective AE will be reported in accordance with MCO 8025.1E (Marine Corps).

b. *Suspension or disposition of ammunition and explosives involved in malfunctions and accidents.* The suspension or disposition of AE involved in malfunctions and accidents will be in accordance with AR 75-1, DA Pam 385-40, and MCOs 8025.1E and P5102.1B. Firing suspensions are published in Technical Bulletin (TB) 9-1300-385, NAVSUP P-801, and appropriate TMs.

(1) Any AE suspended and listed in TB 9-1300-385 or NAVSUP P-801 and their supplements will not be fired in training.

(2) Firing of "restricted" AE listed in TB-9-1300-385 or NAVSUP P-801 and their supplements will be conducted in accordance with the restriction requirements.

(3) AE determined to be defective will not be fired. Defective AE will be reported to the installation quality assurance specialist, ammunition surveillance office or the explosives safety office via the RMA (Army), RCO (Marine Corps). Examples of defects include, but are not limited to:

(a) Fuzes or fuzed rounds that are inadequately tightened, insecurely staked, or missing safety devices.

(b) Safe and arming mechanisms, if so equipped, in an armed position.

(c) AE showing deterioration or corrosion.

(d) AE showing evidence of defects in material or assembly.

(e) AE and/or unopened AE packaging which shows evidence of tampering. It will not be issued until cleared by competent explosives safety authority.

c. *Unexploded ordnance and misfire procedures and reporting.*

(1) The range OIC will report all UXO to the installation RMA (Army), RCO (Marine Corps). In the case of grenades or other munitions that may be immediately hazardous to personnel (for example, bursting radius), firing will be halted until qualified EOD personnel clear the dud. In other cases, firing need not be halted. Duds not cleared by EOD personnel before the unit departs the training complex will be reported in writing to the installation RMA (Army), RCO (Marine Corps) for determination of clearance scope.

(2) Misfire procedures in training manuals/current operating manuals for the appropriate weapon system will be followed. Misfires that present an immediate hazard to personnel or require an immediate cease-fire will be reported to the range operations firing desk (Army), range control (Marine Corps).

(3) AE malfunctions or defects will be reported in accordance with appendix A of AR 75-1 (Army) or MCO 8025.1E (Marine Corps).

(4) Range clearance and destruction of UXO on operational ranges will be in accordance with DODI 3200.16 and approved Service procedures.

d. *Blank ammunition.* The following precautions will be observed during the use of blank ammunition:

(1) The blank firing adapter (BFA) is a necessary component for operational safety. Weapon systems for which approved BFAs are manufactured will not be fired without the proper BFA. The distance at which weapons can be safely fired at unprotected troops without causing injury is somewhat reduced with the BFA. However, 5 m safe separation distance will not be reduced. This distance, with a dispersion angle of 10 degrees left and right of the GTL, does not exclude possible injury to the unprotected eye. Hearing protection (ear plugs) should be worn while firing blank ammunition.

(2) Army combat uniform and Marine Corps combat utility uniforms offer skin protection and should be worn at all times. For Army, eye protection will be used. For Marine Corps, eye protection should be used.

(3) A violation of the safe separation distance could result in serious injury, and within 1 m may cause fatal injuries.

2-11. Range personal protective equipment requirements

a. Training casualties on operational ranges must be minimized through the use of appropriate personal protective equipment (PPE). This pamphlet provides recommendations as to the level of PPE to be used with specific weapon systems. These PPE levels are found in table 2-2. Ultimately, the commander must decide the appropriate level of PPE based on thorough risk assessment.

b. All personnel within the hearing hazard zone will wear approved hearing protection. The size of the hazard zone varies with the weapon. For mixed-use ranges, it is usually convenient to establish the zone based on the loudest weapon used. For administrative convenience, the size of the hearing protection zones can be increased to encompass areas within convenient access or demarcation points. For the Army, the senior commander may, based on risk management, mitigate risk of noise hazard to the lowest possible level consistent with mission accomplishment. The Marine Corps requires that all personnel exposed to gunfire or artillery or missile firing, under any circumstances, will wear hearing protective devices. The following list of distances to the hazard contours for common military weapons is conservative:

- (1) 0.50 caliber: 55 m to the side; 12 m to the rear.
- (2) 0.45 caliber: 12 m to the side; 4.5 m to the rear.
- (3) 9mm: 9 m to the side; 6 m to the rear.
- (4) 7.62mm: 20 m to the side; 8 m to the rear.
- (5) 5.56mm: 24 m to the side; 6 m to the rear.

c. Approved eye protection (or eye armor) will be used, especially during force-on-force training maneuvers or scenarios by personnel undergoing training, as well as those in close proximity (for example, evaluators, observers, and very important persons). Based on risk assessment, the senior commander (Army)/installation commander (Marine Corps) may reduce or eliminate requirement for eye protection, if the decision is made that reduced vision created by use of eye protection outweighs its value. For the Army, to prevent serious eye injury the only approved eye protection for use with close combat mission capability kit (CCMCK) is the standard-issue sun, wind, and dust goggles (national stock number 8465-01-328-8268), which must be worn until all training has ceased.

d. The discharge of weapons creates hazardous impulse noise levels and in the firing range, the impulse noise may act differently when it reflects off hard surfaces. Repeated exposure to impulse noise greater than 140 decibels can cause significant hearing loss. The noise exposure limit is at 84 decibels on the A-weighted scale (decibels (A)) for frequencies of 20 to 16,000 hertz)) for an 8-hour time-weighted average. When time-weighted average exposures are greater than 84 decibels (A), personnel exposed to these activities shall be included in the Hearing Conservation Program.

Table 2-2
Personal protective equipment

Personal protective level	Personal protection required
0 ¹	Army combat uniform/standard utility uniform, hearing/eye protection
1 ¹	Body armor and helmet, hearing/eye protection
2 ¹	Body armor with front/back enhanced small arms protective insert plates and helmet, hearing/eye protection
3	Body armor with front/back/side enhanced small arms protective insert plates and helmet, hearing/eye protection

Notes:

¹ Eye protection is encouraged. Based on risk assessment, the unit commander may require ballistic and/or laser eye protection.

2-12. Army requirements for areas known to contain improved conventional munitions and sub-munitions

This section prescribes Army controls to address hazards associated with maintenance, characterization, clearance, or removal actions at ranges and other areas known to contain ICMs and sub-munitions.

a. *Applicability.*

(1) Activities that involve ICM or sub-munitions undertaken by Active Army, Army National Guard, U.S. Army Reserve personnel, Army civilian employees, Army contractors, and other DOD components.

(2) Operational and former ranges and other areas owned or controlled by the U.S. Army, both in the United States and overseas.

- (3) Activities conducted by other Services on Army-owned or Army-controlled property.
- (4) Does not apply to the following:
 - (a) Research, development, test or evaluation.
 - (b) Acceptance or proof testing.
 - (c) Practice sub-munitions.
 - (d) World War 2-era bomblets (for example, M83 butterfly bombs, and M54 series incendiary bomblets).
 - (e) Formerly used defense sites.

b. Functions.

(1) The Director of Army Safety, Office of Chief of Staff, in coordination with the Office of the Deputy Chief of Staff (ODCS), G-3/5/7 (DAMO-TRS), ODCS, G-4 (DALO-SUM) and Deputy Assistant Secretary of the Army for Environment, Safety and Occupational Health (DASA-ESOH) provide safety oversight and risk assessment criteria for range clearance activities (for example, target maintenance, environmental sampling, and clearance) that may involve ICM or sub-munitions.

(2) The Judge Advocate General is responsible for providing advice on applicable statutory and regulatory requirements affecting activities that involve ICM- and sub-munitions.

(3) The U.S. Army Technical Center for Explosives Safety (USATCES)—

(a) Provides, upon request, comments on requests for Certificates of Risk Acceptance (CoRA) for range clearance activities for areas known or suspected to contain ICMs and sub-munitions.

(b) Maintains an inventory of Army operational and former ranges and other properties where ICMs and sub-munitions are known or suspected to be present.

(4) Commanders—

(a) Ensure that ODCS, G-3/5/7 (DAMO-TRS), Director of Army Safety (DACS-SF), ODCS, G-4 (DALO-AMA), and USATCES (JMAC-ESM) are informed of any ranges or other areas known to contain ICMs or sub-munitions.

(b) Ensure ranges or other areas known to contain ICMs or sub-munitions are clearly marked and entry to these areas is restricted, with access controlled.

(c) Prohibit range clearance activities on operational ranges and removal actions on former ranges, training facilities, or maneuver areas known or suspected to contain ICMs or sub-munitions, unless a CoRA is submitted and approved per DA Pam 385-30.

(d) Have authority to approve CoRA per DA Pam 385-30.

c. Mandatory requirements. Mandatory requirements for operational ranges, training facilities, or maneuver areas known or suspected to contain ICM and sub-munitions.

(1) Ranges, training facilities, or maneuver areas known or suspected to contain ICMs or sub-munitions will be clearly marked, both physically and on the installation's master plans, to identify the hazard. Entry to such areas is prohibited with any authorized access to be strictly controlled.

(2) Before access is granted to an operational range, training facility, or maneuver area, the installation RMA will determine whether ICM or sub-munitions are known or suspected to be present. The RMA, in coordination with installation safety and EOD representatives, will determine if it is safe to authorize access and establish prerequisite precautions. Personnel authorized access to areas known or suspected to contain ICMs or sub-munitions will be fully advised of the potential dangers and safeguards to be followed, and escorted by EOD or UXO-qualified personnel.

(3) If an ICM or sub-munition is found on a range, training facility, or maneuver area that is not known to contain ICM or sub-munitions, use of the range will be suspended until the installation range operations conducts the procedures in paragraph 2-11c. The expeditious destruction of any ICM or sub-munition(s) encountered is authorized.

(4) Range operations or safety personnel will ensure that previously unreported areas known or suspected to contain ICM or sub-munitions are reported immediately through command channels to the ODCS, G-3/5/7 (DAMO-TR), Director of Army Safety (DACS-SF), ODCS, G-4 (DALO-AMA), and USATCES (JMAC-ESM). At a minimum, the report will include the location, the type of ICM or sub-munition, the boundaries (by coordinates) of the area, the suspected source (for example, weapon system and event in which the ICM or sub-munitions were most likely used), the date of discovery, a point of contact, and, if available, digital pictures of the discovered item. The location should be marked on the installation master plan and local supporting EOD units should be notified.

d. Certificate of Risk Acceptance.

(1) A CoRA is required prior to the conduct of clearance activities or a removal action in an area where ICMs or sub-munitions are known or suspected to be present.

(2) A CoRA will be developed and approved per DA Pam 385-30.

(3) Copies of approved CoRA will be electronically forwarded to: Office of the Chief of Staff, Director of Army Safety (DACS-SF), with copies furnished to ODCS's Director of Training G-3/5/7 (DAMO-TR), (DASA-ESOH)'s Assistant for Munitions and Chemical Matters), ODCS's G-4 (DALO-AMA), and USATCES (JMAC-ESM).

(4) An amended CoRA will be submitted for any condition that increases the level of explosive safety risk.

e. Hazard control requirements.

- (1) Operations will be conducted in a manner that exposes the minimum number of people to the smallest quantity of explosives for the shortest period of time.
- (2) All work activities will be coordinated with and have the approval of all appropriate levels of command and all organizations or Services involved.
- (3) All work activities will be conducted per controls outlined in approved planning documents (for example, work plans, explosives safety risk assessments, hazard analyses, and site safety and health plans).
- (4) Only EOD or UXO-qualified personnel may conduct clearance or removal actions in areas known or suspected to contain ICMs or sub-munitions. Qualifications for UXO personnel are in DDESB Technical Paper 18.
- (5) The final disposition of UXO that are ICMs and/ or sub-munitions will be per EOD-approved procedures. When possible, such military munitions will be blown in place. Prior to destruction of the UXO, all personnel will be removed beyond the specified safe separation distance.
- (6) Should an explosive-related incident involving injury to personnel occur:
 - (a) It will be reported per AR 385-10.
 - (b) All activities will be stopped until a review and validation of procedures has been completed and approved by the commander with responsibility for the activities.

Chapter 3 Danger Zones

3-1. General

a. Every weapon system and the ammunition/ordnance related to that weapon system requires a danger zone. The danger zones in this pamphlet represent minimum safety requirements; they are adequate only when employed with properly functioning safety equipment and devices, and when trained and competent personnel follow published firing procedures. They are three-dimensional areas derived from computer modeling and/or laboratory data. Danger zone size and shape are dependent on the performance characteristics of the weapon system, ammunition, training requirements, geographical location, and environmental conditions. They should not account for human error.

b. Danger zones can be constructed manually or by using geo-spatial data and the RMTK in either a desktop or web-based environment. The RMTK can be downloaded (desktop) and/or accessed (Web-based) at <https://srp.army.mil> or <https://rtam.tecom.usmc.mil>.

3-2. Types of danger zones

There are three types of danger zones:

a. *Laser surface danger zone (air-to-ground; ground-to-ground)*. A LSDZ consists of the target area in addition to horizontal and vertical buffer zones. It reflects the minimum land and air requirement, to include terrain mitigation, needed to safely employ a given laser. The LSDZ accounts for direct hazards (main beam) and indirect hazards (reflections). The boundaries of the LSDZ depend on which of the two overlapping zones, direct or indirect, are larger. If there are no specular reflectors on the range and the laser does not present a diffuse reflection hazard, there will not be an indirect hazard zone. LSDZs must accommodate stationary firing points (fixed positions) as well as mobile firing positions, in addition to fixed and moving targets. Figure 3-1 contains the basic elements of a LSDZ.

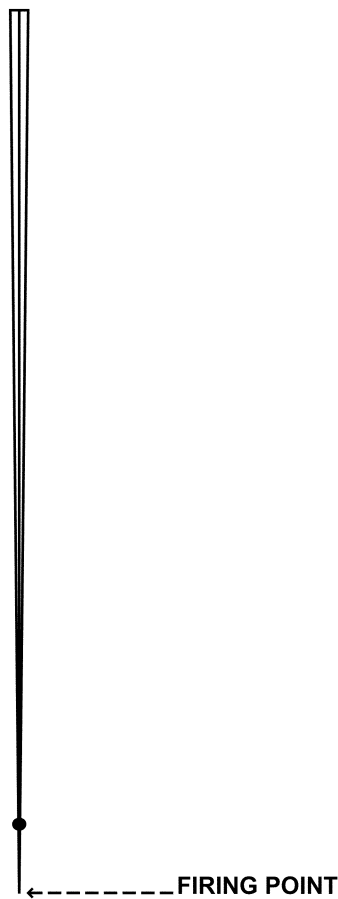

Figure 3-1. Basic elements of a laser surface danger zone

b. Surface danger zone (ground-to-ground). An SDZ delineates that portion of the earth and the air above in which personnel and/or equipment may be endangered by ground weapons firing or demolition activities. These SDZs are designed to make the probability of hazardous fragment or round escapement from installation boundaries unlikely and minimize the danger to the public, installation personnel, facilities/equipment, or property. The two basic SDZs are the cone and the "batwing." The batwing SDZ provides for greater containment of ricochets. Figures 3-2 and 3-3 contain cone and batwing SDZs for small arms direct-fire weapons without explosive projectiles. Figures 3-4 and 3-5 are cone and batwing SDZs for small arms direct-fire weapons with explosive projectiles. Figures 3-6 and 3-7 are SDZs for mortars and field artillery cannon in the indirect fire mode. Certain weapons, for example, tube-launched, optically-tracked, wire-guided (TOW) and FGM-148 Javelin missiles, have unique SDZs. They will be addressed in the appropriate chapter.

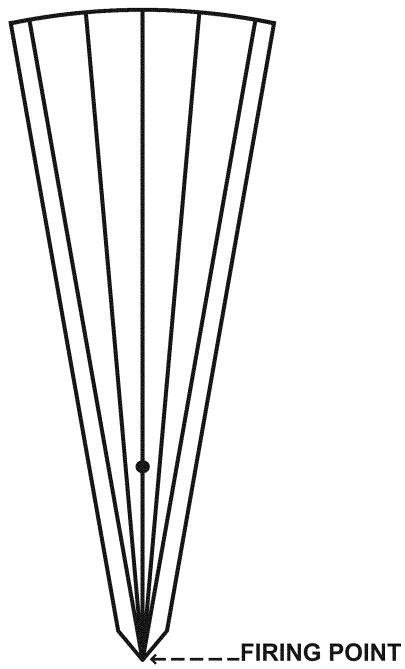

Figure 3-2. Cone surface danger zone for small arms direct-fire weapons without explosive projectiles

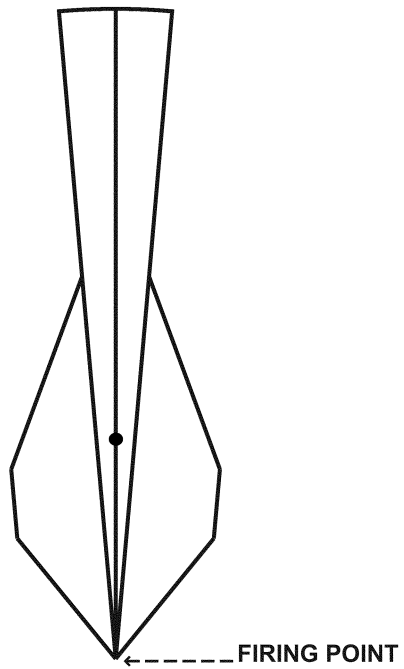

Figure 3-3. Batwing surface danger zone for small arms direct-fire weapons without explosive projectiles

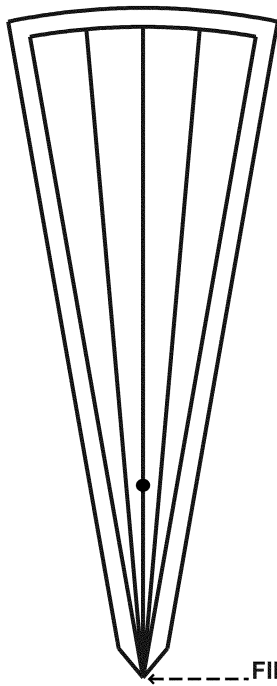

Figure 3-4. Cone surface danger zone for small- arms direct-fire weapons with explosive projectiles

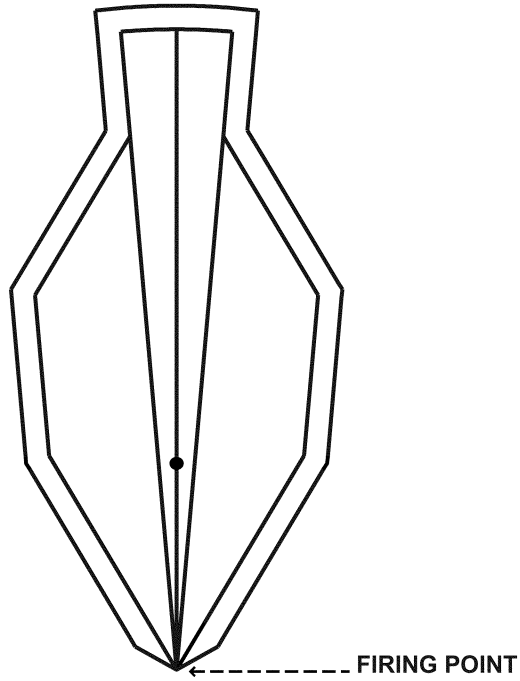

Figure 3-5. Batwing surface danger zone for small- arms direct-fire weapons with explosive projectiles

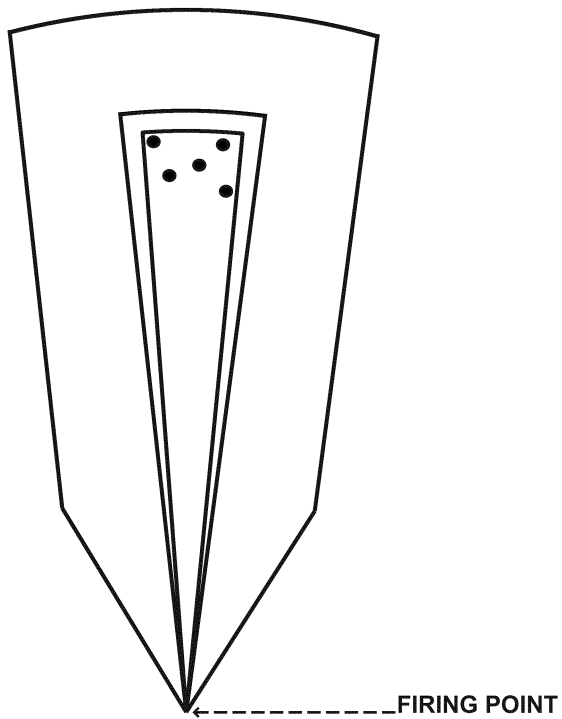

Figure 3-6. Surface danger zone for indirect fire, mortars

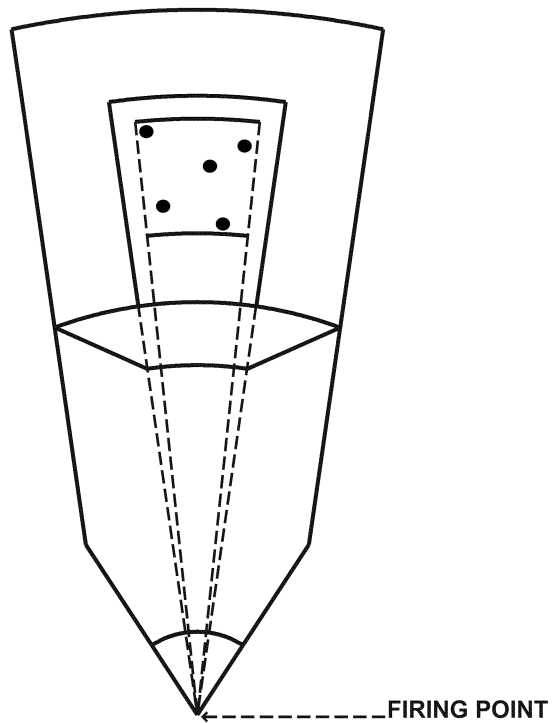

Figure 3-7. Surface danger zone for indirect fire, field artillery cannon

(1) *Multiple firing point/target surface danger zones.* A single SDZ for a particular weapon system may be expanded to accommodate multiple firing positions and/or targets for that weapon system. Figure 3-8 contains a SDZ for multiple fixed firing positions and multiple fixed targets. Figure 3-9 contains a SDZ for a single fixed firing position and multiple fixed targets. Figure 3-10 contains a SDZ with multiple fixed firing points and single fixed target. Figure 3-11 contains a SDZ with multiple fixed firing points and multiple fixed or moving targets.

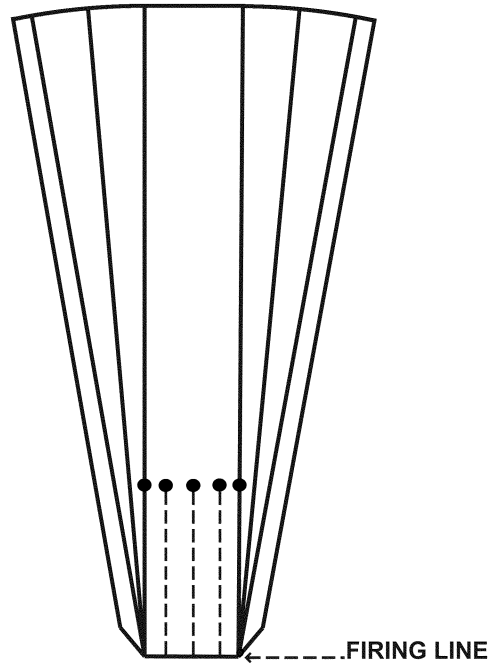

Figure 3-8. Multiple surface danger zone; multiple fixed firing points and multiple fixed targets

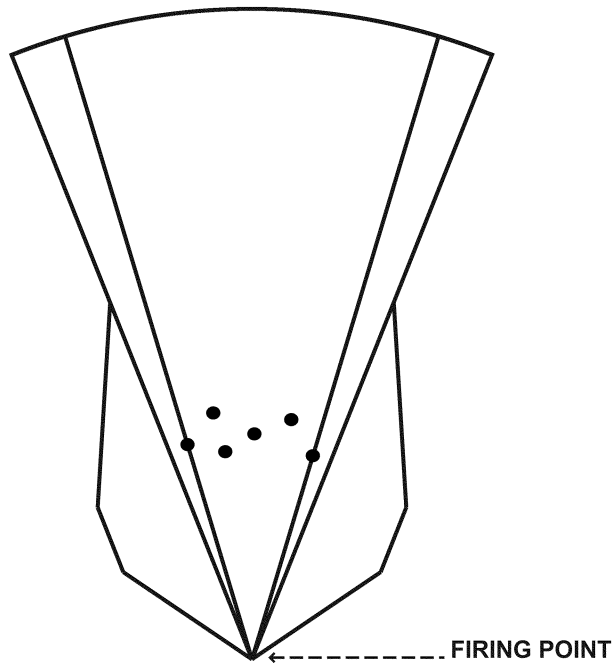

Figure 3-9. Multiple surface danger zone for single fixed firing point and multiple fixed targets

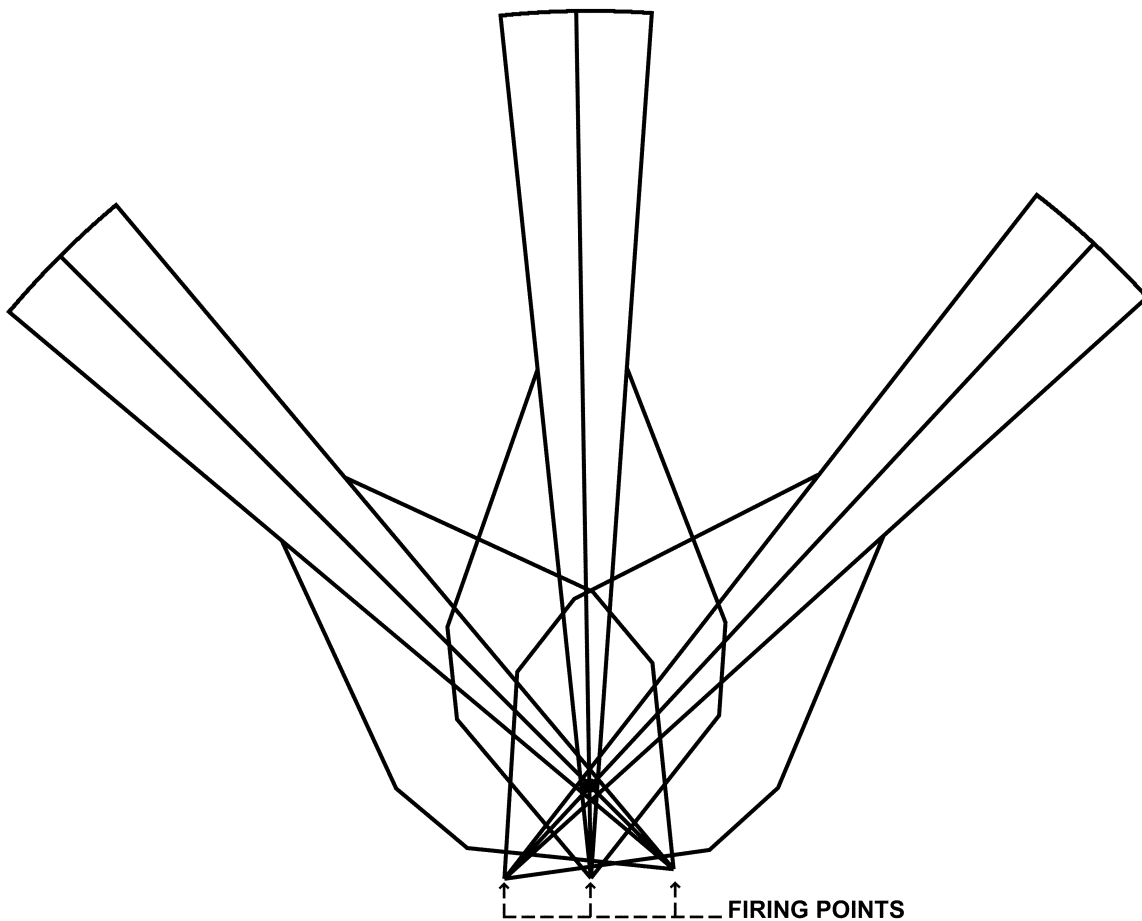

Figure 3-10. Multiple surface danger zone with multiple fixed firing points and a single fixed target

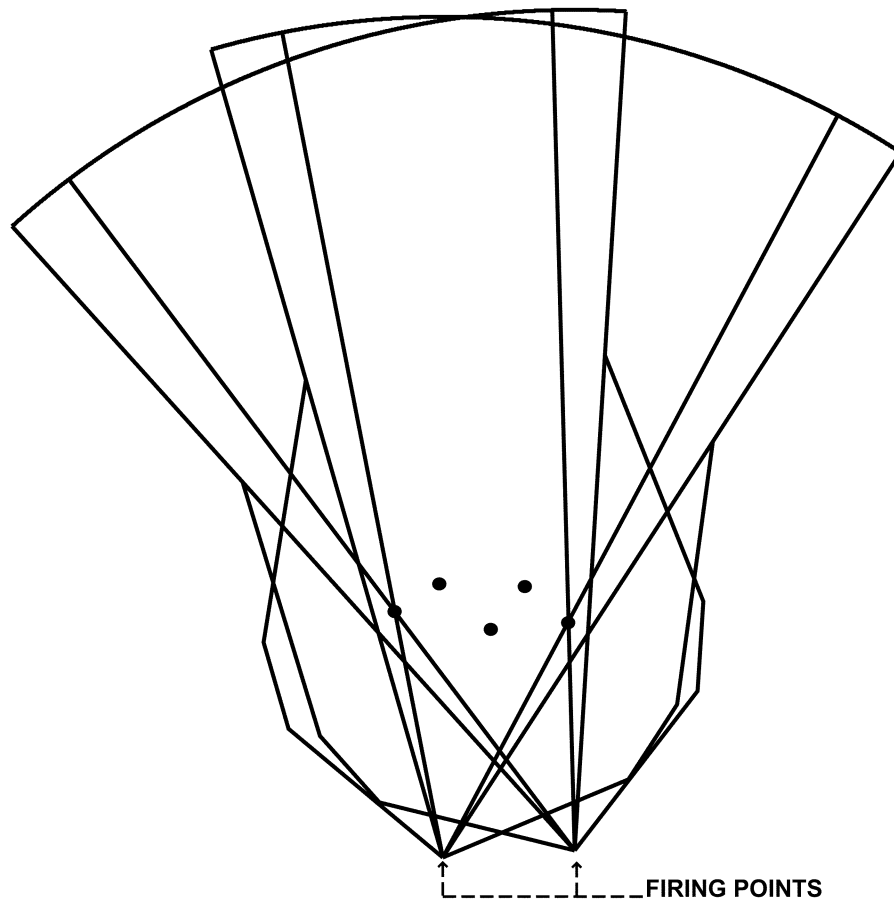

Figure 3–11. Multiple surface danger zone with multiple fixed firing points and multiple fixed or moving targets

(2) *Movement box.* A movement box is designed to accommodate movement to an objective. Shooters move within the designated "box" and may engage multiple targets or moving targets down range. For the Marine Corps, movement boxes for live-fire maneuver/movement exercises will use the batwing SDZ. For the Army, the batwing SDZ will be considered for movement boxes for live-fire maneuver/movement exercises. Figure 3–12 contains a movement box with the batwing SDZ. Target engagement scenarios must ensure fires remain within the established SDZ.

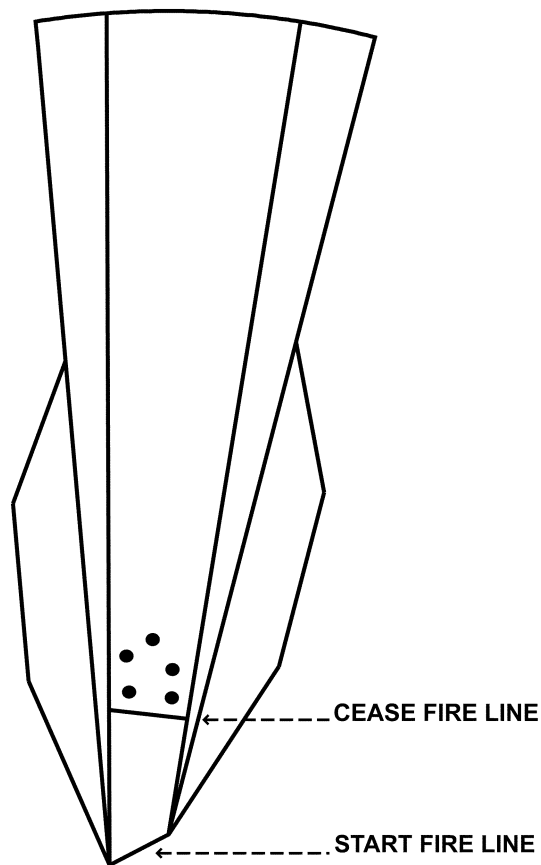

Figure 3–12. Movement box, multiple firing points, and fixed or moving targets

(3) Composite danger zones.

(a) CALFEXs (Army) and CAXs (Marine Corps) involve combined arms teams conducting coordinated fire and maneuver training in executing the assault, seizure, and defense of appropriate objectives. Tactical air support may be included with appropriate WDZs. Combining multiple danger zones for a CALFEX/CAX scenario is the definitive application of danger zones. Regardless of the number and types of danger zones a CALFEX/CAX requires, a systematic approach will result in successful definition of each LSDZ/SDZ/WDZ and allow training to be safely accomplished.

(b) Danger zones of multiple weapon systems in a CALFEX/CAX scenario result in a composite LSDZ/SDZ/WDZ. The composite LSDZ/SDZ/WDZ identifies total real estate requirements at a given sequence (or phase) of the exercise. Numerous sequenced or time-phased composite danger zones may exist depending on the complexity of a particular CALFEX/CAX. Figure 3–13 is a composite SDZ.

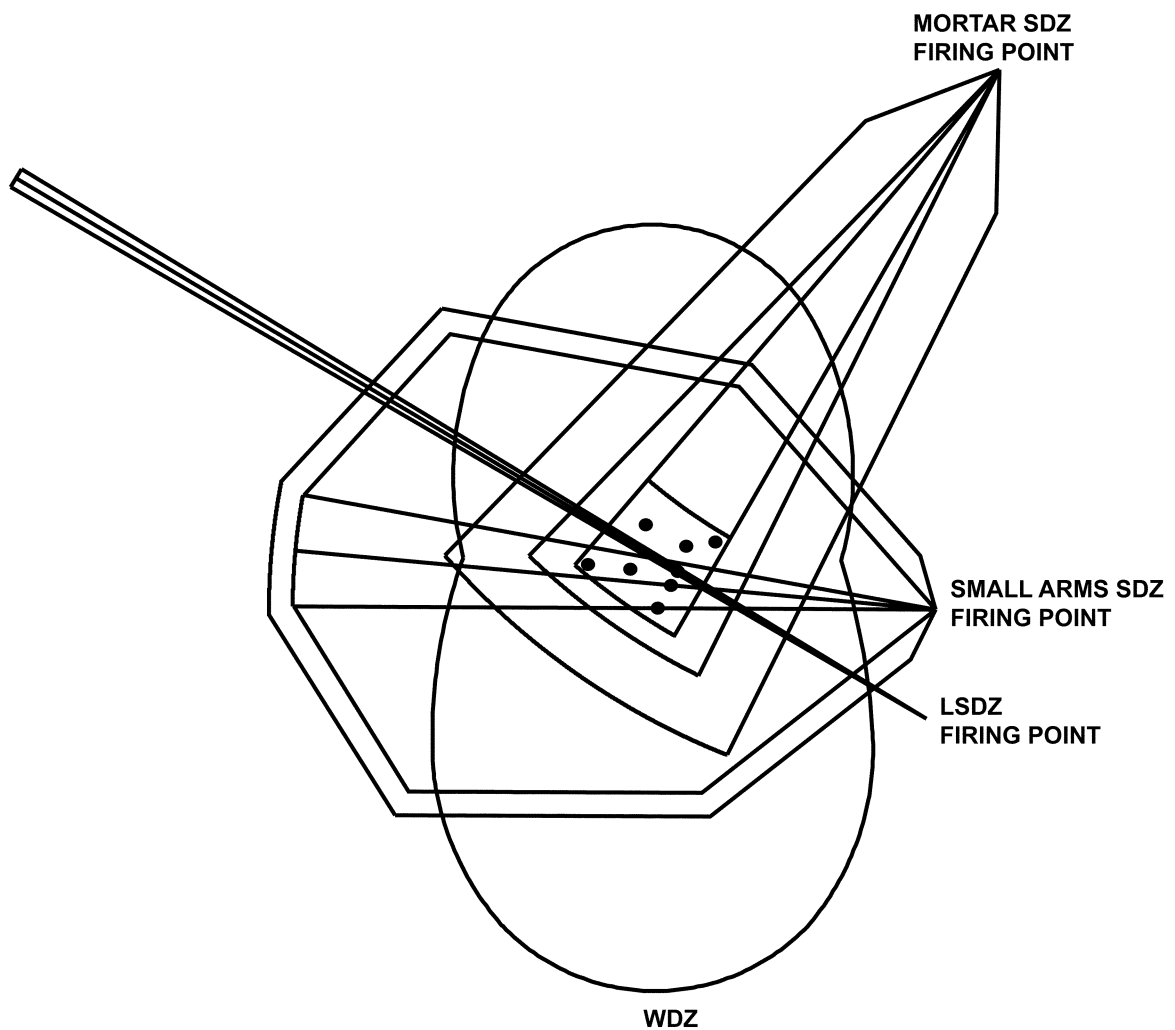

Figure 3-13. Composite surface danger zone

c. *Weapons danger zone (air-to-ground)*. A WDZ encompasses the ground and airspace for lateral and vertical containment of projectiles, fragments, debris, and components resulting from the firing, launching, and detonation of aviation-delivered ordnance. It reflects the minimum land and air requirement, to include terrain mitigation, needed to safely employ a given weapon. The WDZ accounts for inaccuracy, failures, ricochets, and broaching/porpoising of a specific weapon/munition type delivered by a specific aircraft type. The WDZ "footprint" is based on weapon characteristics, type of delivery being executed, platform (aircraft) delivering the ordnance, target and soil characteristics, terrain, and level of containment acceptable to the senior commander (Army)/installation commander (Marine Corps). Figure 3-14 depicts the basic elements of a WDZ.

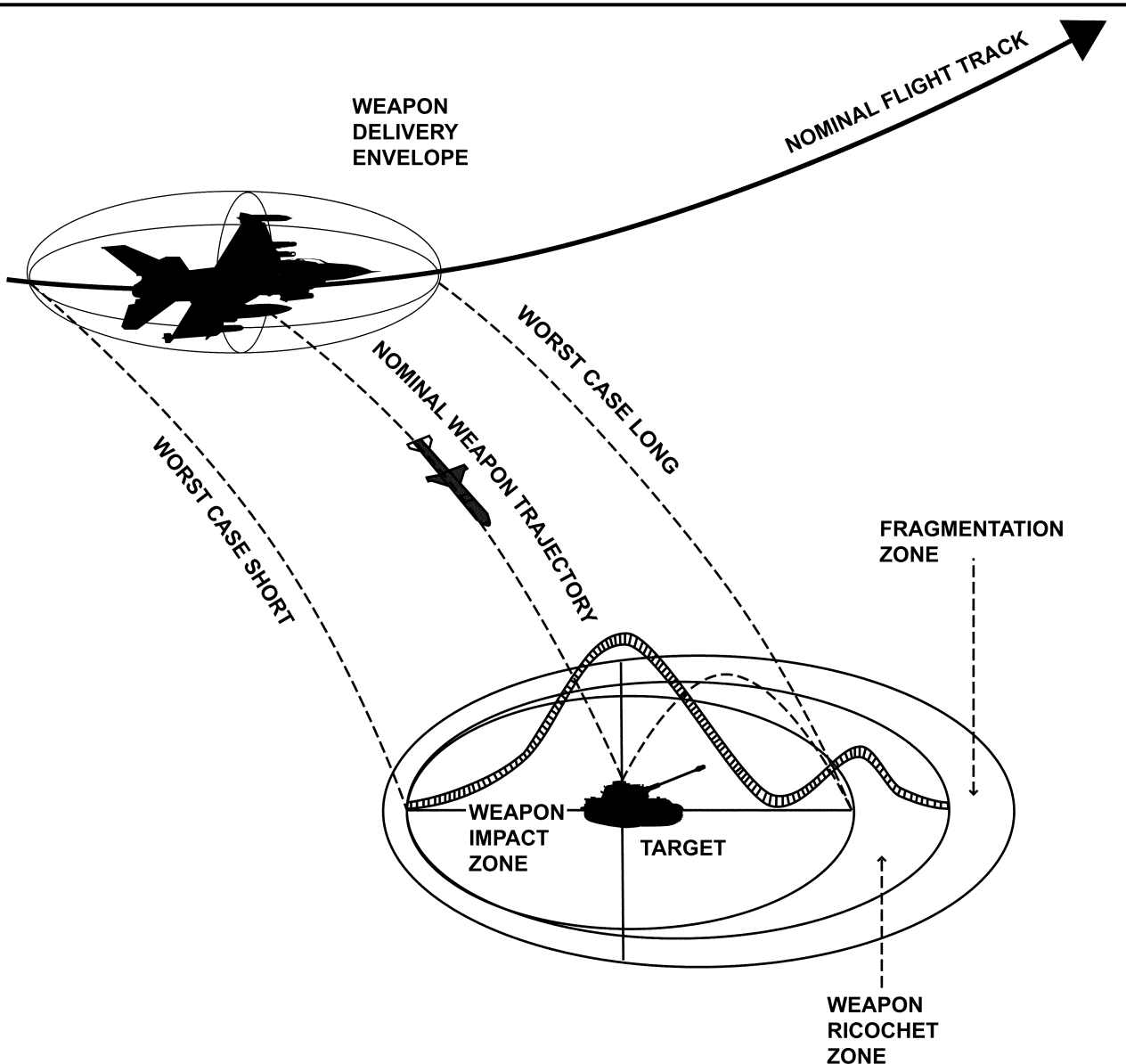

Figure 3-14. Basic weapon danger zone profile

3-3. Authorization for personnel within danger zones

a. The following personnel are authorized to be within a danger zone, subject to the restrictions in the applicable sections of this pamphlet and application of the risk management process by the senior commander (Army)/installation commander (Marine Corps):

- (1) Crews directly involved in the firing of a weapon system or munition.
- (2) Tactical air control party or joint terminal attack controllers (JTACs) controlling aviation ordnance deliveries.
- (3) Cannon launched guided projectile (Copperhead) fire support team (FIST) personnel located in the mission essential area (MEA). FIST personnel will only be allowed within the SDZ when the Copperhead is not fired in the ballistic mode.
- (4) Aircrew operating within danger zones as part of an exercise.
- (5) During indirect field artillery firing personnel may be in Areas A through E subject to the restrictions in chapter 10.
- (6) Designator operators (laser) during AGM-114 HELLFIRE antitank guided missile operations.
- (7) Personnel down range when approved overhead small arms ammunition is fired.

- (8) Personnel wearing approved laser eye protection within the LSDZ.
- (9) Personnel down range when supporting training on known distance firing ranges, when protection is provided.
 - b. Authorization of any other personnel within danger zones requires deviation approval per AR 385–63/MCO 3570. 1C and paragraph 1–4 of this pamphlet.

Chapter 4

Small Arms

4–1. Firing conditions

a. For the purpose of this pamphlet, small arms are man-portable, individual and crew-served weapon systems of 30 mm or less used primarily against personnel and lightly armored or unarmored equipment. Small arms SDZ diagrams and tables provided in this chapter are the standard for the proper construction of small arms direct fire SDZs with or without exploding projectiles.

b. The cone SDZ may be applied when designing or conducting training on static/known distance style ranges that do not involve fire and movement or fire and maneuver. Figure 4–1 is a cone SDZ for firing small arms direct-fire weapons without exploding projectiles. Figure 4–2 is a cone SDZ for firing small arms direct-fire weapons with exploding projectiles.

c. The batwing SDZ provides for greater containment of all ricochets. For the Army, the batwing will be considered when designing or conducting training on ranges that involve fire and movement, fire and maneuver, flanking fire, and/or when ricochet hazards outside the range boundary may endanger nonparticipating personnel. Decision on use of batwing will be based on level of risk and approval of appropriate command risk acceptance authority in accordance with DA Pam 385–30. For the Marine Corps the batwing will be applied when designing or conducting training on ranges that involve fire and movement, fire and maneuver, flanking fire, and/or when ricochet hazards outside the range boundary may endanger nonparticipating personnel. Figures 4–3 and 4–4 are batwing SDZs for firing small arms direct-fire weapons without exploding projectiles. Figure 4–5 is a batwing SDZ for firing small arms direct-fire weapons with exploding projectiles.

d. When firing small arms with or without exploding projectiles on small arms ranges with known distance and unknown distances involving hand-held and shoulder-fired weapons or weapons firing from ground or vehicle-mounted platforms, the standard 5 degree dispersion area for the SDZ may be reduced to 2 degrees when:

(1) Conducting static (non-fire and movement/maneuver) training on known distance and unknown distance small arms ranges with hand-held or shoulder-fired weapons when firing from fixed or stationary positions.

(2) Training on ranges involving personnel conducting precision fires from stationary positions.

(3) Ground-mounted weapons conducting static (non-fire and movement/maneuver) training on known distance and unknown distance small arms ranges that are mounted on appropriate tripods. The traversing and elevation mechanism for that weapon system will be used for all fires.

(4) Vehicle-mounted weapons conducting static (non-fire and movement/maneuver) training on known distance and unknown distance small arms ranges are mounted on appropriate vehicle mounts. The traversing and elevation mechanism for that weapon system will be used and locked in place for all fires.

(5) Risk management process documentation for the unit conducting training has been approved by the installation RMA (Army), RCO (Marine Corps) or other appropriate approving authority. Training events in which the SDZ dispersion area has been reduced from 5 to 2 degrees will be specifically addressed in the risk management worksheet.

4–2. Surface danger zones

a. Surface danger zone data for small arms is found in tables 4–1 through 4–23. The column “Ricochet Vert Haz” contains data which represent ricochet vertical hazard only.

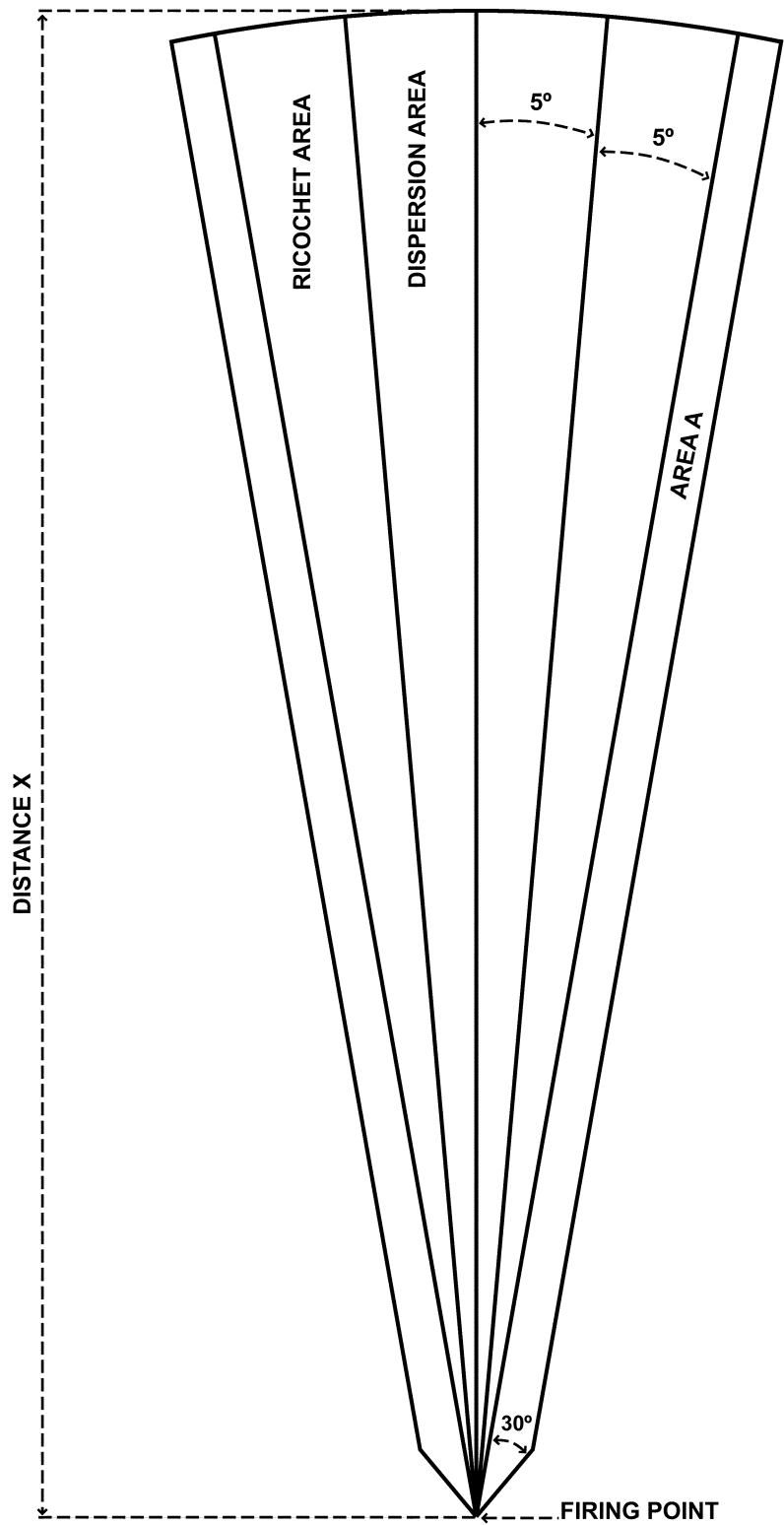

Figure 4-1. Cone surface danger zone for firing small arms direct-fire weapons without exploding projectiles

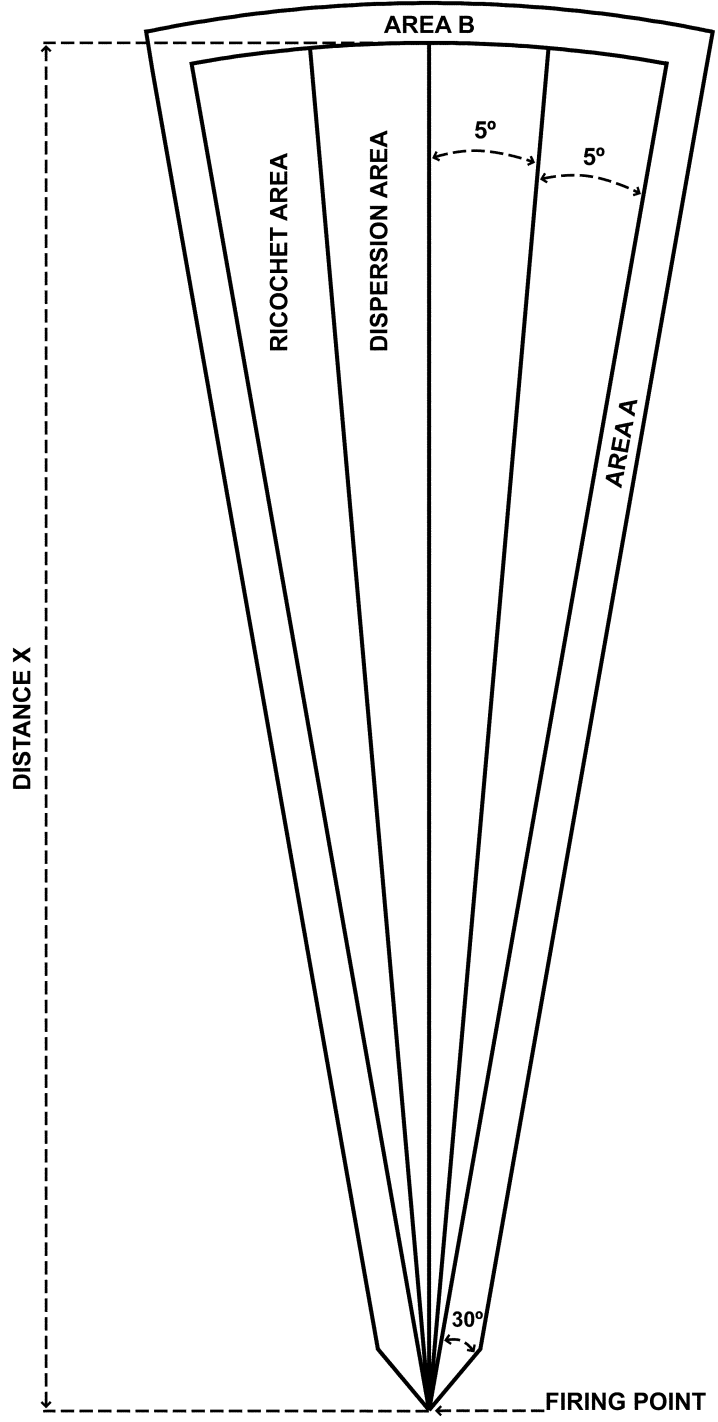

Figure 4-2. Cone surface danger zone for firing small arms direct-fire weapons with exploding projectiles

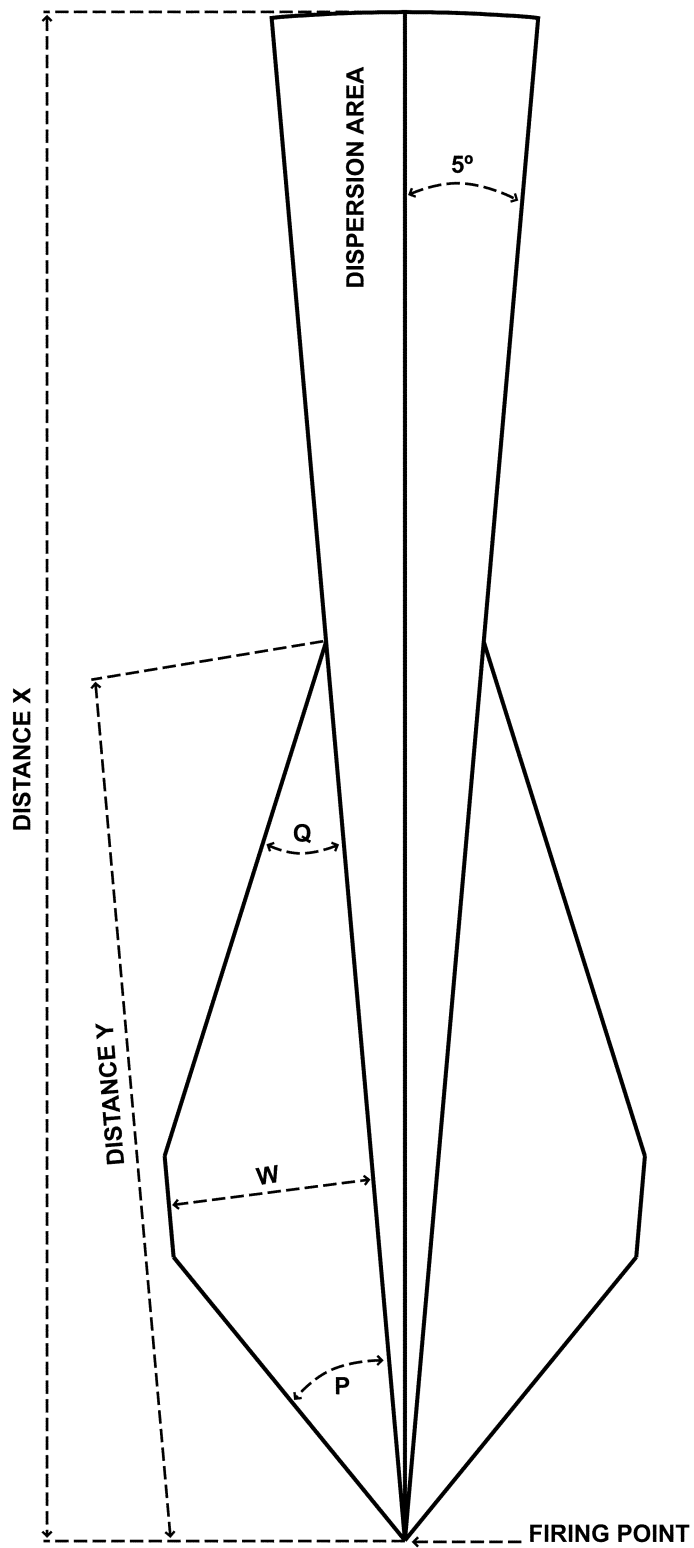

Figure 4-3. Batwing surface danger zone for firing small arms direct-fire weapons without exploding projectiles, except 5.56mm M1037 Short Range Training Ammunition

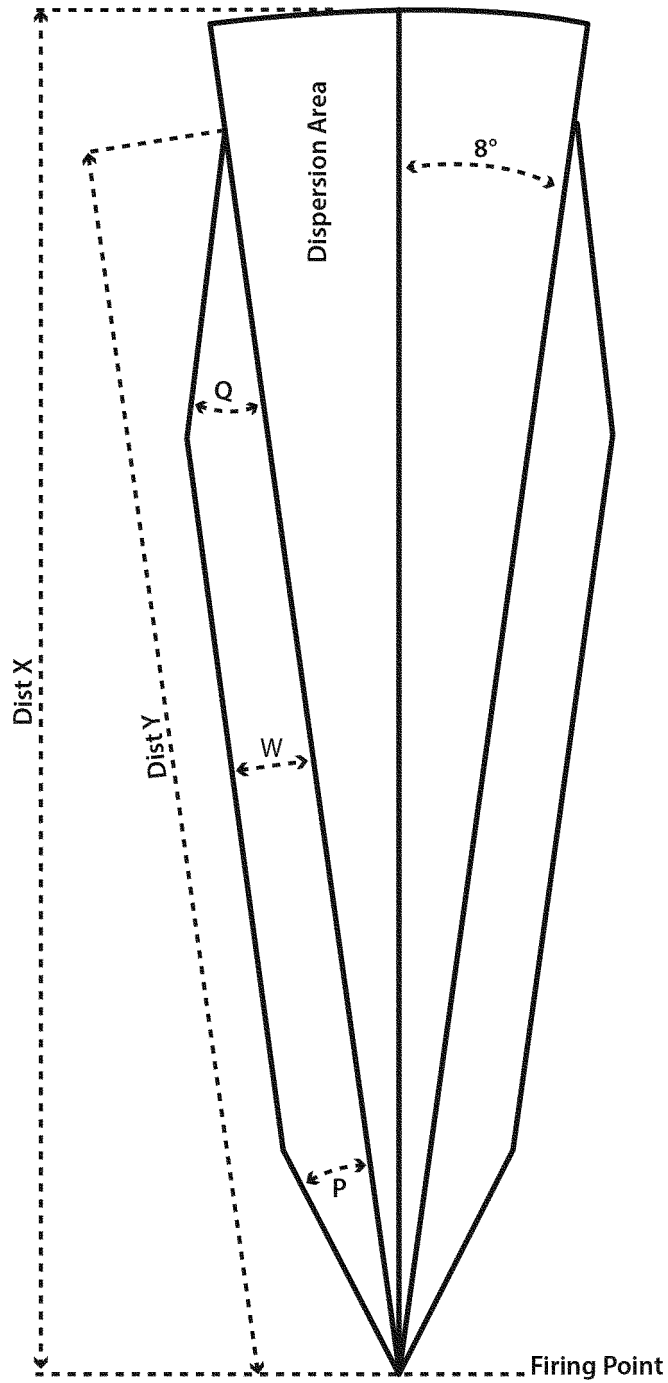

Figure 4-4. Batwing surface danger zone for firing 5.56mm M1037 Short Range Training Ammunition

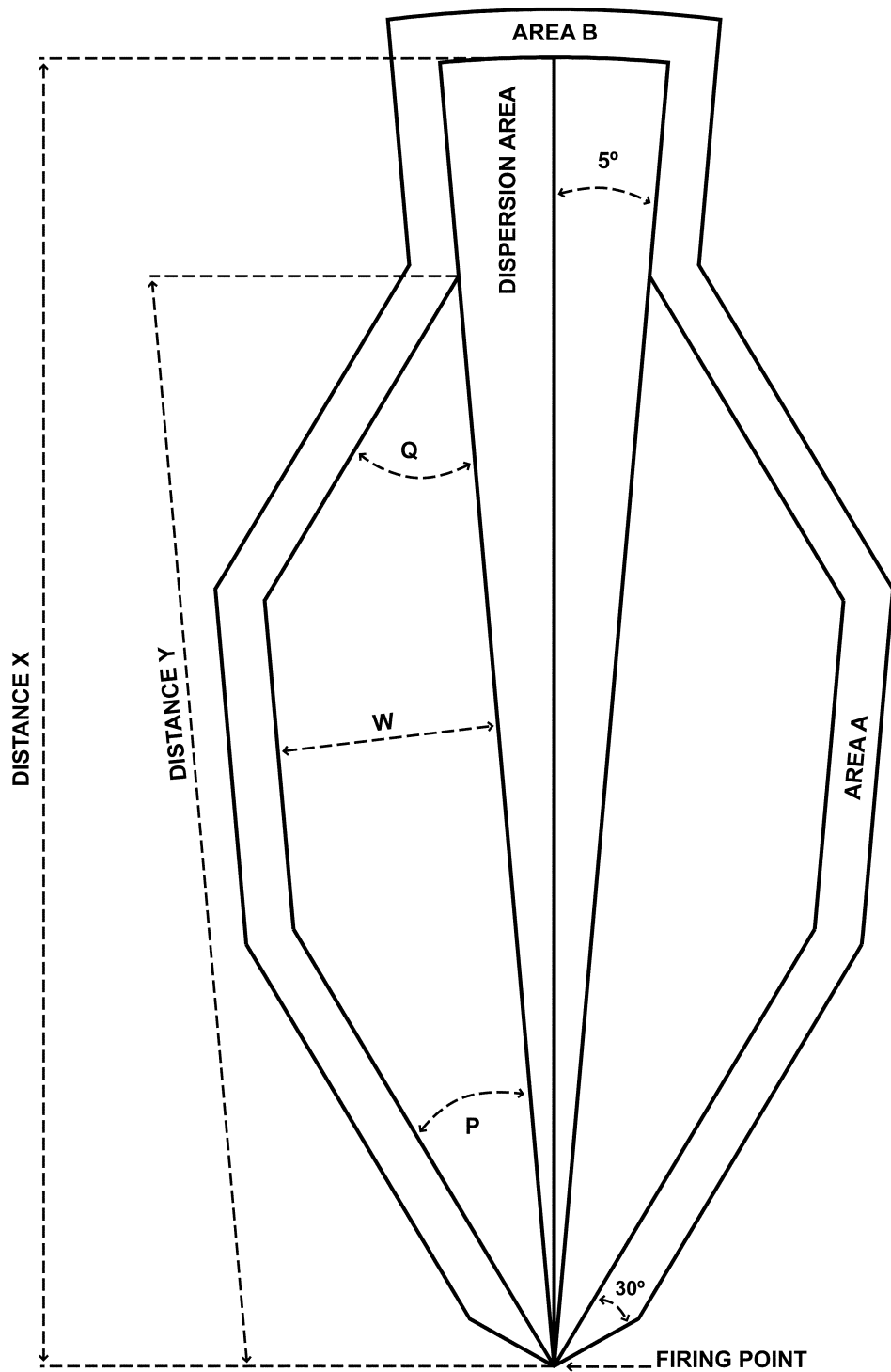

Figure 4-5. Batwing surface danger zone for firing small arms direct-fire weapons with exploding projectiles

b. Figure 4-6 is the SDZ for the M903 sabot light armor penetrator (SLAP), M962 SLAP tracer (SLAP-T), MK 211 armor-piercing-incendiary (API), MK 211-0 API-tracer (API-T) .50 caliber ammunition.

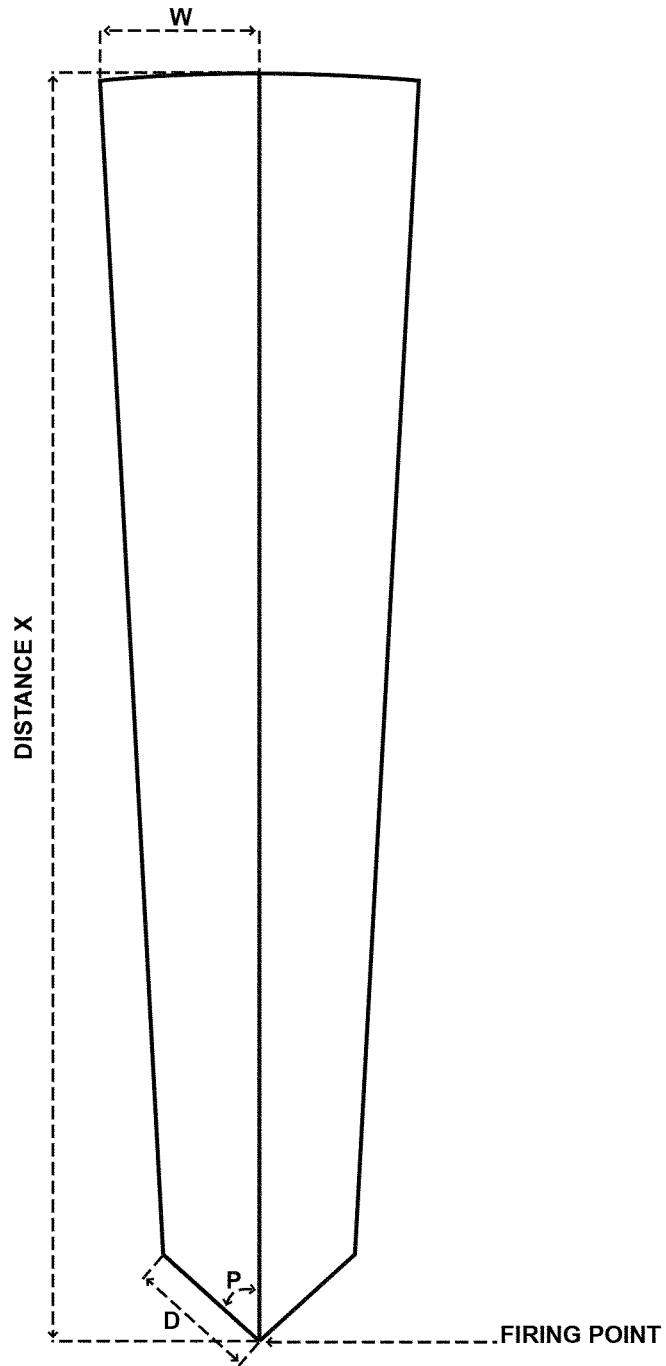

Figure 4-6. Surface danger zone for M903, M962, MK211, and MK 211-0 .50 caliber ammunition

c. Figure 4-7 is the .50 caliber M903 SLAP and M962 SLAP-T sabot discard area.

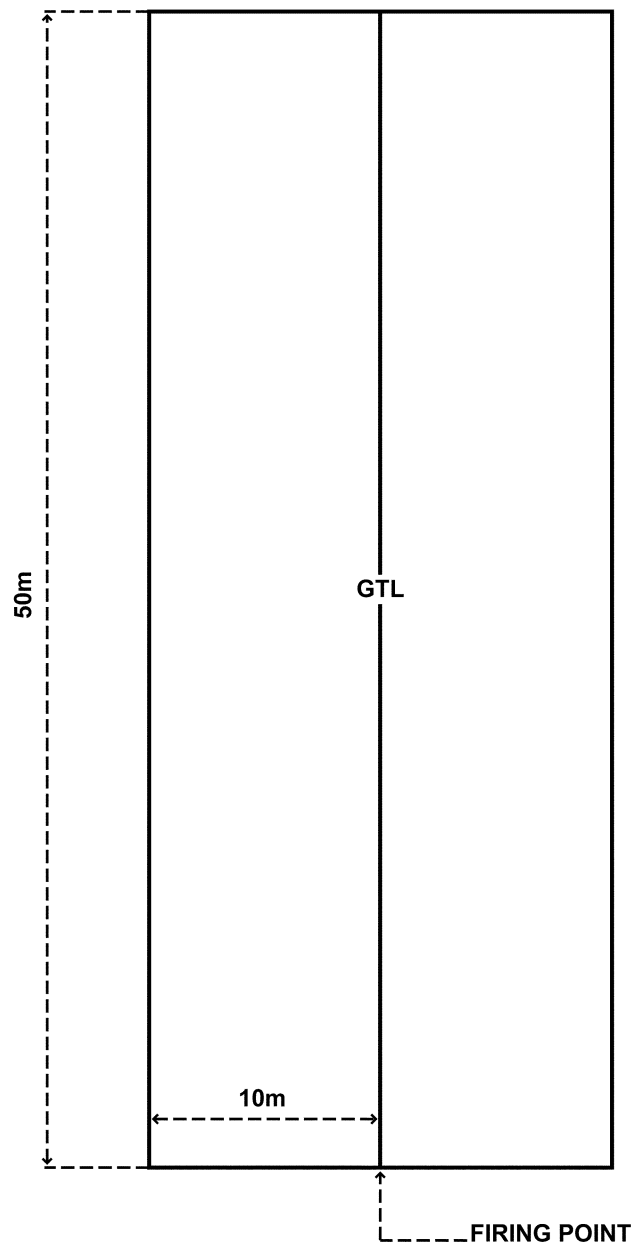

Figure 4-7. Surface danger zone for .50 caliber M903 SLAP and M962 SLAP-T ammunition sabot discard area

d. When firing the 12-gauge shotgun with 7½, 8 and 9 shot, use the SDZ shotfall data provided in figure 4-8. All 12-gauge buckshot, slug, or other shot larger than 7½ shot will use data provided in figures 4-1 and 4-3, and table 4-1.

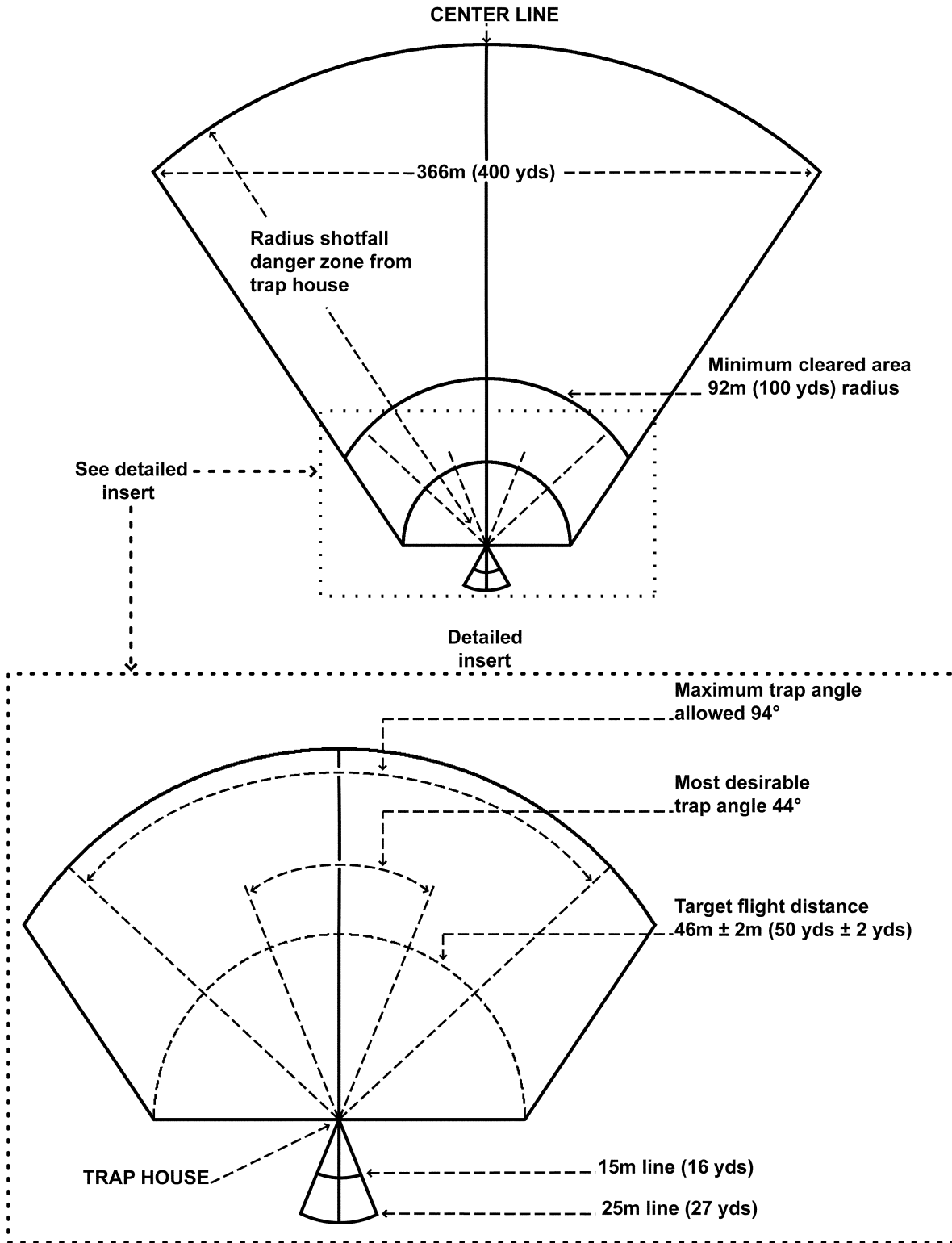

Figure 4-8. Surface danger zone for shotfall

e. Table 4–1 contains SDZ data for 12-gauge ammunition small arms direct-fire weapons.

Table 4–1
Surface danger zone data for 12-gauge ammunition small arms direct-fire weapons

Ammunition 12-gauge	Impact media	Distance X (m)	Distance Y (m)	Distance W (m)	Area A ¹ (m)	Area B (m)	Angle P (deg)	Angle Q (deg)	Ricochet vertical hazard (m)
12-gauge slug, shot size larger than 7½	Earth/ Water Steel/ Concrete	1,073	710	125	100	NR	21.96	33.34	136
		1,073	830	287	100	NR	56.91	40.17	197
12-gauge 7½, 8, and 9 shot	Earth/ Water Steel/ Concrete	275	NR	NR	NR	NR	NR	NR	NR
		275	NR	NR	NR	NR	NR	NR	NR
12-gauge XM1030 Breaching	Earth/ Water Steel/ Concrete	375	NR	NR	NR	NR	12.50	NR	NR
		375	NR	NR	NR	NR	12.50	NR	NR

Legend for Table 4-1:

NR=not required

Notes:

¹ Area A applies to cone SDZ only.

f. Table 4–2 contains SDZ data for small arms blank ammunition with BFA.

Table 4–2
Surface danger zone data for all small arms blank ammunition with blank firing adapter

Ammunition Blank	Impact media	Distance X (m)	Distance Y (m)	Distance W (m)	Area A ¹ (m)	Area B (m)	Angle P (deg)	Angle Q (deg)	Ricochet vertical hazard (m)
Small arms 5.56mm, 7.62mm, .50 caliber	NR	5	NR	NR	NR	NR	NR	NR	NR

Legend for Table 4-2:

NR=not required

Notes:

¹ The dispersion and ricochet area for all ammunition is 10 degrees.

g. Table 4–3 contains SDZ data for .22 caliber ammunition, small arms direct-fire weapons.

Table 4–3
Surface danger zone data for .22 caliber ammunition small arms direct-fire weapons

Ammunition .22 caliber	Impact media	Distance X (m)	Distance Y (m)	Distance W (m)	Area A ¹ (m)	Area B (m)	Angle P (deg)	Angle Q (deg)	Ricochet vertical hazard (m)
Ball LR	Earth/ Water Steel/ Concrete	1,400	1,033	155	100	NR	24.00	15.90	96
		1,400	1,125	386	100	NR	63.40	30.30	245

Legend for Table 4-3:

NR=not required

Notes:

¹ Area A applies to cone SDZ only.

h. Table 4–4 contains SDZ data for 9mm small arms direct-fire weapons.

Table 4–4
Surface danger zone data for 9mm small arms direct-fire weapons

Ammunition 9mm ¹	Impact media	Distance X (m)	Distance Y (m)	Distance W (m)	Area A ² (m)	Area B (m)	Angle P (deg)	Angle Q (deg)	Ricochet vertical hazard (m)
Ball M882, M1, Subsonic	Earth/ Water	1,800	1,077	158	100	NR	23.10	15.80	93
	Steel/ Concrete	1,800	1,211	399	100	NR	61.10	30.40	253

Legend for Table 4-4:

NR=not required

Notes:

¹ SDZ data for Special Effects Small Arms Marking System (SESAMS) and CCMCK ammunition is located in chapter 14 of this publication.

² Area A applies to cone SDZ only.

i. Table 4–5 contains SDZ information for .38 caliber small arms direct-fire weapons.

Table 4–5
Surface danger zone data for .38 caliber small arms direct-fire weapons

Ammunition .38 caliber	Impact media	Distance X (m)	Distance Y (m)	Distance W (m)	Area A ¹ (m)	Area B (m)	Angle P (deg)	Angle Q (deg)	Ricochet vertical hazard (m)
38 caliber Spec Ball M41, .38 Wadcutter	Earth/ Water	1,806	1,110	153	100	NR	22.57	16.07	89
	Steel/ Concrete	1,806	1,258	389	100	NR	60.59	35.36	245

Legend for Table 4-5:

NR=not required

Notes:

¹ Area A applies to cone SDZ only.

j. Table 4–6 contains SDZ information for .45 caliber small arms direct-fire weapons.

Table 4–6
Surface danger zone data for .45 caliber small arms direct-fire weapons

Ammunition .45 caliber	Impact media	Distance X (m)	Distance Y (m)	Distance W (m)	Area A ¹ (m)	Area B (m)	Angle P (deg)	Angle Q (deg)	Ricochet vertical hazard (m)
Ball, Tracer, Wad- cutter, Match	Earth/ Water	1,690	1,016	117	100	NR	21.11	16.69	100
	Steel/ Concrete	1,690	1,111	290	100	NR	54.74	30.77	186

Legend for Table 4-6:

NR=not required

Notes:

¹ Area A applies to cone SDZ only.

k. Table 4–7 contains SDZ data for 5.56mm small arms direct-fire weapons.

Table 4–7
Surface danger zone data for 5.56mm small arms direct-fire weapons

Ammunition 5.56mm ¹	Impact media	Distance X (m)	Distance Y (m)	Distance W (m)	Area A ² (m)	Area B (m)	Angle P (deg)	Angle Q (deg)	Ricochet vertical hazard (m)
M193 Ball	Earth/ Water Steel/ Concrete	3,100	2,004	458	100	NR	35.20	23.10	319
		3,100	1,666	323	100	NR	19.00	26.90	219
M196 Tracer	Earth/ Water Steel/ Concrete	3,100	2,066	362	100	NR	35.10	26.80	355
		3,100	2,023	243	100	NR	19.20	22.80	243
M855 Ball	Earth/ Water Steel/ Concrete	3,437	2,029	462	100	NR	34.20	22.40	325
		3,437	1,810	334	100	NR	18.80	25.20	229
M856 Tracer	Earth/ Water Steel/ Concrete	3,089	1,607	355	100	NR	32.80	23.20	261
		3,089	1,592	277	100	NR	18.60	21.00	261
4 Ball/1 Tracer F/SAW	Earth/ Water Steel/ Concrete	3,437	2,029	462	100	NR	34.20	22.40	325
		3,437	1,810	334	100	NR	18.80	25.20	261
M862 Plastic Short Range	Earth/ Water Steel/ Concrete	250	165	24	100	NR	15.40	20.00	16
		250	136	5	100	NR	3.30	7.30	4

Legend for Table 4-7:

NR=not required

Notes:

¹ SDZ data for CCMCK ammunition located in chapter 14 in this publication.

² Area A applies to cone SDZ only.

l. Table 4–8 contains SDZ data for 5.56mm M855A1 enhanced performance round ball ammunition.

Table 4–8
Surface danger zone data for 5.56mm M855A1 enhanced performance round (ball)

Altitude (ft)	Impact media	Distance X ¹ (m)	Distance Y (m)	Distance W (m)	Area A ² (m)	Area B (m)	Angle P ³ (deg)	Angle Q (deg)	Ricochet vertical hazard (m)
0	Earth Armor	3,521	3,100	400	100	NR	60	15	295
		3,521	3,050	360	100	NR	45	14	272
1,000	Earth Armor	3,630	3,200	420	100	NR	60	15	305
		3,630	3,150	370	100	NR	45	14	280
2,000	Earth Armor	3,743	3,300	430	100	NR	60	15	314
		3,743	3,250	390	100	NR	45	14	288
3,000	Earth Armor	3,859	3,400	440	100	NR	60	15	324
		3,859	3,350	400	100	NR	45	14	297
4,000	Earth Armor	3,980	3,500	450	100	NR	60	15	334
		3,980	3,450	420	100	NR	45	14	306
5,000	Earth Armor	4,105	3,600	460	100	NR	60	15	344
		4,105	3,550	430	100	NR	45	14	315

Table 4-8
Surface danger zone data for 5.56mm M855A1 enhanced performance round (ball)—Continued

Altitude (ft)	Impact media	Distance X ¹ (m)	Distance Y (m)	Distance W (m)	Area A ² (m)	Area B (m)	Angle P ³ (deg)	Angle Q (deg)	Ricochet vertical hazard (m)
6,000	Earth	4,234	3,700	470	100	NR	60	15	354
	Armor	4,234	3,650	440	100	NR	45	14	324
7,000	Earth	4,369	3,800	490	100	NR	60	15	365
	Armor	4,369	3,750	450	100	NR	45	14	333

Legend for Table 4-8:

NR=not required

Notes:

¹ Distance X must increase by 29m per m/sec or 15m per knot of tail wind, measured along the line of fire.

² Area A applies to cone SDZ only.

³ Ricochet Angle P is measured from the dispersion angle. To correct for cross-range winds, the dispersion angle must increase by 0.4 degrees per m/s or 0.2 degrees/knot of cross wind, measured perpendicular to the line of fire.

m. Table 4-9 contains SDZ data for 5.56mm Cartridge, M856A1 Tracer.

Table 4-9
Surface danger zone data for 5.56mm Cartridge, M856A1 Tracer

Altitude (ft)	Impact media	Distance X ¹ (m)	Distance Y (m)	Distance W (m)	Angle P ² (deg)	Angle Q (deg)	Ricochet vertical hazard (m)
0	Earth	2,574	1,625	190	58.00	19.00	162
	Armor	2,574	1,900	210	48.00	15.00	171
1,000	Earth	2,657	1,679	197	58.30	19.15	166
	Armor	2,657	1,958	217	48.15	15.15	177
2,000	Earth	2,742	1,733	204	58.60	19.30	171
	Armor	2,742	2,016	224	48.30	15.30	183
3,000	Earth	2,831	1,787	211	58.90	19.45	177
	Armor	2,831	2,074	231	48.45	15.45	188
4,000	Earth	2,924	1,841	218	59.20	19.60	182
	Armor	2,924	2,132	238	48.60	15.60	194
5,000	Earth	3,020	1,895	225	59.50	19.75	189
	Armor	3,020	2,190	245	48.75	15.75	201
6,000	Earth	3,120	1,949	232	59.80	19.90	195
	Armor	3,120	2,248	252	48.90	15.90	207
7,000	Earth	3,224	2,003	239	60.10	20.05	201
	Armor	3,224	2,306	259	49.05	16.05	214

Notes:

¹ Distance X is for firing elevations up to maximum range and considers both free flight and ricochet trajectories. To correct for tail winds, Distance X must increase by 25m per m/s or 13m per knot of tail wind measured along the line of fire.

² Angle P is measured from the dispersion angle. To correct for cross range winds, the dispersion angle must increase by 0.45 degree per m/s or 0.23 degree per knot of cross range wind measured perpendicular to the line of fire.

n. Table 4-10 contains SDZ data for 5.56mm Cartridge, MK301 Dim Tracer.

Table 4–10
Surface danger zone data for 5.56mm Cartridge, MK301 Dim Tracer

Altitude (ft)	Impact media	Distance X ¹ (m)	Distance Y (m)	Distance W (m)	Angle P ² (deg)	Angle Q (deg)	Ricochet vertical hazard (m)
0	Earth	2,324	1,920	190	51.30	13.75	158
	Armor	2,324	1,655	145	41.70	11.75	100
1,000	Earth	2,396	1,973	196	51.15	13.85	164
	Armor	2,396	1,708	149	41.60	11.85	104
2,000	Earth	2,472	2,026	202	51.00	13.95	170
	Armor	2,472	1,761	153	41.50	11.95	108
3,000	Earth	2,550	2,079	208	50.85	14.05	176
	Armor	2,550	1,814	157	41.40	12.05	112
4,000	Earth	2,632	2,132	214	50.70	14.15	182
	Armor	2,632	1,867	161	41.30	12.15	116
5,000	Earth	2,716	2,185	220	50.55	14.25	188
	Armor	2,716	1,920	165	41.20	12.25	120
6,000	Earth	2,804	2,238	226	50.40	14.35	194
	Armor	2,804	1,973	169	41.10	12.35	124
7,000	Earth	2,896	2,291	232	50.25	14.45	200
	Armor	2,896	2,026	173	41.00	12.45	128

Notes:

¹ To correct for tail winds, Distance X must increase by 24m per m/s or 12.5 meters per knot of tail wind measured along the line of fire.

² Ricochet Angle P is measured from the dispersion angle. To correct for cross range winds, the dispersion angle must increase by 0.50 degree per m/s or 0.26 degree per knot of cross range wind measured perpendicular to the line of fire.

o. Table 4–11 contains SDZ data for 5.56mm Cartridge, M1037 Short Range Training Ammunition.

Table 4–11
Surface danger zone data for 5.56mm Cartridge, M1037 Short Range Training Ammunition

Altitude (ft)	Impact media	Distance X ¹ (m)	Distance Y (m)	Distance W (m)	Angle P ² (deg)	Angle Q (deg)	Ricochet vertical hazard (m)
0	Earth	370	345	22	16.9	13.0	16
	Armor	370	345	9	6.2	3.9	9
1,000	Earth	381	355	23	16.9	13.3	17
	Armor	381	355	9	6.2	3.9	9
2,000	Earth	393	365	24	16.9	13.6	17
	Armor	393	365	10	6.2	3.9	9
3,000	Earth	405	385	25	17.8	13.8	18
	Armor	405	385	10	6.3	3.9	10
4,000	Earth	418	395	25	18.0	14.0	18
	Armor	418	395	10	6.3	3.9	10
5,000	Earth	431	405	27	18.4	14.2	19
	Armor	431	405	10	6.4	3.9	10
6,000	Earth	445	414	27	18.4	14.5	20
	Armor	445	414	10	6.4	3.9	11
7,000	Earth	459	424	27	18.4	14.8	20

Table 4–11
Surface danger zone data for 5.56mm Cartridge, M1037 Short Range Training Ammunition—Continued

Altitude (ft)	Impact media	Distance X ¹ (m)	Distance Y (m)	Distance W (m)	Angle P ² (deg)	Angle Q (deg)	Ricochet vertical hazard (m)
	Armor	459	424	10	6.5	3.9	11

Notes:

¹ To correct for tail winds, Distance X must increase by 10m per m/s or 5m per knot of tail wind measured along the line of fire.

² Angle P is measured from the dispersion angle. To correct for cross range winds, the 8 degree dispersion angle must increase by 1.10 degree per m/s or 0.55 degree per knot of cross range wind measured perpendicular to the line of fire.

p. Table 4–12 contains SDZ data for 7.62mm small arms direct-fire weapons.

Table 4–12
Surface danger zone data for 7.62mm small arms direct-fire weapons

Ammunition 7.62mm ¹	Impact media	Distance X (m)	Distance Y (m)	Distance W (m)	Area A ² (m)	Area B (m)	Angle P (deg)	Angle Q (deg)	Ricochet vertical hazard (m)
M59,M80 Ball, M62	Earth/Water Steel/Concrete	4,100	4,073	1,461	100	NR	43.54	38.90	706
		4,100	4,053	861	100	NR	20.04	75.54	447
7.62X39 mm A102 intermediate designed for AK series, SKS, RPK	Earth/Water Steel/Concrete	4,100	4,073	1,461	100	NR	43.54	38.90	706
		4,100	4,053	861	100	NR	20.04	75.54	447
M118 Spec Ball, M85	Earth/Water Steel/Concrete	5,288	4,800	1,545	100	NR	43.81	38.73	752
		5,288	5,137	990	100	NR	20.17	41.29	490

Legend for Table 4-12:

NR=not required

Notes:

¹ For the 7.62 39mm (AK) the only authorized standard Department of Defense identification code (DODIC) to be used is A102.

² Area A applies to cone SDZ only.

q. Table 4–13 contains SDZ data for 7.62mm M993 armor piercing small arms weapons ammunition.

Table 4–13
Surface danger zone data for M993 7.62mm armor piercing

Altitude (ft)	Impact media	Distance X (m)	Distance Y (m)	Distance W (m)	Area A ¹ (m)	Area B (m)	Angle P (deg)	Angle Q (deg)	Ricochet vertical hazard (m)
0	Earth Steel	4,100	4,084	330	100	NR	33.32	5.97	224
		4,100	4,084	330	100	NR	33.32	5.97	224
1,000	Earth Steel	4,195	4,179	338	100	NR	33.51	6.00	229
		4,195	4,179	338	100	NR	33.51	6.00	229
2,000	Earth Steel	4,290	4,274	346	100	NR	33.69	6.03	234
		4,290	4,274	346	100	NR	33.69	6.03	234
3,000	Earth Steel	4,385	4,368	354	100	NR	33.87	6.06	239
		4,385	4,368	354	100	NR	33.87	6.06	239
4,000	Earth Steel	4,480	4,463	362	100	NR	34.04	6.09	244
		4,480	4,463	362	100	NR	34.04	6.09	244
5,000	Earth Steel	4,575	4,558	370	100	NR	34.20	6.12	249
		4,575	4,558	370	100	NR	34.20	6.12	249
6,000	Earth Steel	4,670	4,652	378	100	NR	34.36	6.14	254
		4,670	4,652	378	100	NR	34.36	6.14	254

Table 4–13
Surface danger zone data for M993 7.62mm armor piercing—Continued

Altitude (ft)	Impact media	Distance X (m)	Distance Y (m)	Distance W (m)	Area A ¹ (m)	Area B (m)	Angle P (deg)	Angle Q (deg)	Ricochet vertical hazard (m)
7,000	Earth	4,765	4,747	386	100	NR	34.51	6.17	259
	Steel	4,765	4,747	386	100	NR	34.51	6.17	259

Legend for Table 4-13:

NR=not required

Notes:

¹ Area A applies to cone SDZ only.

r. Table 4–14 contains SDZ data for 7.62mm Cartridge, M276 Dim Tracer.

Table 4–14
Surface danger zone data for 7.62mm Cartridge, M276 Dim Tracer

Altitude (ft)	Impact media	Distance X ¹ (m)	Distance Y (m)	Angle P ² (deg)	Angle Q (deg)	Area W (m)	Area A ³ (m)	Area B (m)	Ricochet vertical hazard (m)
0	Armor	2,932	2,192	44.3	11.0	234	100	NR	165
	Earth	2,932	1,118	22.0	15.3	106	100	NR	83
1,000	Armor	3,032	2,242	44.2	10.9	238	100	NR	170
	Earth	3,032	1,238	22.2	15.0	114	100	NR	84
2,000	Armor	3,132	2,342	44.1	10.9	244	100	NR	175
	Earth	3,132	1,242	22.3	14.8	116	100	NR	86
3,000	Armor	3,232	2,392	44.0	10.8	248	100	NR	180
	Earth	3,232	1,287	22.5	14.5	118	100	NR	88
4,000	Armor	3,332	2,492	44.0	10.8	258	100	NR	186
	Earth	3,332	1,330	22.7	14.2	122	100	NR	90
5,000	Armor	3,432	2,542	43.9	10.7	266	100	NR	192
	Earth	3,432	1,382	22.9	13.9	134	100	NR	92
6,000	Armor	3,557	2,642	43.8	10.7	276	100	NR	198
	Earth	3,557	1,436	23.0	13.7	239	100	NR	94
7,000	Armor	3,677	2,742	43.7	10.6	286	100	NR	204
	Earth	3,677	1,485	23.2	13.4	144	100	NR	96

Notes:

¹ To correct for tail wind, Distance X is increased by 36 m per m/sec or 18.5m per knot of tail wind measured along the line of fire.

² To correct for cross range winds, the dispersion angle must be increased by 0.30 degree per m/s or 0.16 degree per knot of cross range wind measured perpendicular to the line of fire.

³ Area A applies to cone SDZ only.

s. Table 4–15 contains SDZ data for M973 Ball and M974 Tracer 7.62mm short range training ammunition. These rounds are designed to be ballistically comparable to 7.62mm M80 Ball and M62 Tracer service ammunition out to 100 m.

Table 4–15
Surface danger zone data for M973 Ball and M974 Tracer 7.62mm short range training ammunition^{1,2}

Altitude (ft)	Impact media	Distance X (m)	Distance Y (m)	Distance W (m)	Area A ³ (m)	Area B (m)	Angle P ⁴ (deg)	Angle Q (deg)	Ricochet vertical hazard (m)
0	Earth	540	500	105	100	NR	38	45	178
	Steel	540	500	30	100	NR	10	20	178
1,000	Earth	565	520	110	100	NR	38	45	184
	Steel	565	520	32	100	NR	10	20	184
2,000	Earth	590	540	115	100	NR	38	45	190
	Steel	590	540	34	100	NR	10	20	190
3,000	Earth	615	560	120	100	NR	38	45	196
	Steel	615	560	36	100	NR	10	20	196
4,000	Earth	640	580	125	100	NR	38	45	202
	Steel	640	580	38	100	NR	10	20	202
5,000	Earth	665	600	130	100	NR	38	45	208
	Steel	665	600	40	100	NR	10	20	208
6,000	Earth	690	620	135	100	NR	38	45	214
	Steel	690	620	42	100	NR	10	20	214
7,000	Earth	715	640	140	100	NR	38	45	220
	Steel	715	640	44	100	NR	10	20	220

Legend for Table 4-15:

NR=not required

Notes:

¹ For SDZ construction use figure 4–3, with the following change: Dispersion, use a dispersion angle of 12 degrees.

² Single hearing protection should be worn by all personnel within 24m when M973 Ball and/or M974 Tracer ammunition is being fired.

³ Area A applies to cone SDZ only.

⁴ To correct for cross wind, dispersion angle is increased by 0.8 degree per m/s or 0.4 degree per knot of cross wind, measured perpendicular to the line of fire

t. Table 4–16 contains SDZ data for MK 248 MOD 0 .300 caliber Winchester Magnum small arms direct-fire ammunition.

Table 4–16
Surface danger zone data for MK 248 MOD 0 .300 Winchester Magnum small arms direct-fire ammunition¹

Altitude (ft)	Impact media	Distance X ² (m)	Distance Y (m)	Distance W (m)	Area A ³ (m)	Area B (m)	Angle P ⁴ (deg)	Angle Q (deg)	Ricochet vertical hazard (m)
0	Earth	5,919	4,200	390	100	NR	40.00	10.00	322
	Armor	5,919	2,300	180	100	NR	28.00	12.00	128
1,000	Earth	6,078	4,336	399	100	NR	40.45	10.30	340
	Armor	6,078	2,358	187	100	NR	27.75	12.15	138
2,000	Earth	6,242	4,472	408	100	NR	40.90	10.60	358
	Armor	6,242	2,416	194	100	NR	27.50	12.30	150
3,000	Earth	6,411	4,608	417	100	NR	41.35	10.90	382
	Armor	6,411	2,474	201	100	NR	27.25	12.45	160
4,000	Earth	6,584	4,744	426	100	NR	41.80	11.20	410
	Armor	6,584	2,532	208	100	NR	27.00	12.60	165
5,000	Earth	6,763	4,880	435	100	NR	42.25	11.50	433
	Armor	6,763	2,590	215	100	NR	26.75	12.75	180
6,000	Earth	6,947	5,016	444	100	NR	42.70	11.80	457
	Armor	6,947	2,648	222	100	NR	26.50	12.90	194

Table 4-16
Surface danger zone data for MK 248 MOD 0 .300 Winchester Magnum small arms direct-fire ammunition¹—Continued

Altitude (ft)	Impact media	Distance X ² (m)	Distance Y (m)	Distance W (m)	Area A ³ (m)	Area B (m)	Angle P ⁴ (deg)	Angle Q (deg)	Ricochet vertical hazard (m)
7,000	Earth Armor	7,137	5,152	453	100	NR	43.15	12.10	484
		7,137	2,706	229	100	NR	26.25	13.05	208

Legend for Table 4-16:

NR=not required

Notes:

¹ Single hearing protection should be worn by all personnel within 34 m when MK248 MOD 0 ammunition is being fired.

² Distance X must increase by 37 m per m/sec or 19 m per knot of tail wind, measured along the line of fire.

³ Area A applies to cone SDZ only.

⁴ Dispersion angle of 5 degrees must increase by 0.28 degree per or 0.15 degree per knot of cross wind, measured perpendicular to the line of fire.

u. Table 4-17 contains surface danger zone data for MK 248 MOD 1 .300 caliber Winchester Magnum small arms direct-fire ammunition.

Table 4-17
Surface danger zone data for MK 248 MOD 1 .300 Winchester Magnum small arms direct-fire ammunition¹

Altitude (ft)	Impact media	Distance X ² (m)	Distance Y (m)	Distance W (m)	Area A ³ (m)	Area B (m)	Angle P ⁴ (deg)	Angle Q (deg)	Ricochet vertical hazard (m)
0	Earth Armor	6,294	4,600	390	100	NR	39.00	14.00	350
		6,294	3,800	220	100	NR	24.00	10.00	146
1,000	Earth Armor	6,462	4,675	402	100	NR	39.15	14.60	372
		6,462	3,858	227	100	NR	23.75	10.15	155
2,000	Earth Armor	6,635	4,750	414	100	NR	39.30	15.20	397
		6,635	3,916	234	100	NR	23.50	10.30	165
3,000	Earth Armor	6,814	4,825	426	100	NR	39.45	15.80	424
		6,814	3,974	241	100	NR	23.25	10.45	175
4,000	Earth Armor	6,998	4,900	438	100	NR	39.60	16.40	440
		6,998	4,032	248	100	NR	23.00	10.60	187
5,000	Earth Armor	7,188	4,975	450	100	NR	39.75	17.00	468
		7,188	4,090	255	100	NR	22.75	10.75	198
6,000	Earth Armor	7,384	5,050	462	100	NR	39.90	17.60	500
		7,384	4,148	262	100	NR	22.50	10.90	211
7,000	Earth Armor	7,587	5,125	474	100	NR	40.05	18.20	533
		7,587	5,206	269	100	NR	22.25	11.05	223

Legend for Table 4-17:

NR=not required

Notes:

¹ Single hearing protection should be worn by all personnel within 34 m when MK248 MOD 1 ammunition is being fired.

² Distance X must increase by 40 meters m/sec or 21 m per knot of tail wind, measured along the line of fire.

³ Area A applies to cone SDZ only.

⁴ Dispersion angle must increase by 0.28 degree per m/s or 0.15 degree per knot of cross range wind, measured perpendicular to the line of fire.

v. Table 4-18 contains SDZ data for .50 caliber small arms direct-fire ammunition.

Table 4–18
Surface danger zone data for .50 caliber small arms direct-fire

Ammunition .50 caliber	Impact media	Distance X (m)	Distance Y (m)	Distance W (m)	Area A¹ (m)	Area B (m)	Angle P (deg)	Angle Q (deg)	Ricochet vertical hazard (m)
M8 API, M2 AP, M20, M1	Earth/ Water Steel/ Concrete	6,100	5,142	1,659	100	NR	40.80	69.60	904
		6,100	4,300	718	100	NR	16.30	33.10	462
M33 Ball, M2 Ball, M17, M10, M17, Spot-ter Tracer	Earth/ Water Steel/ Concrete	6,500	5,211	1,652	100	NR	38.19	63.35	901
		6,500	4,147	714	100	NR	16.03	44.13	478
M858 Ball Plastic, M860 Tracer Plastic	Earth/ Water Steel/ Concrete	700	398	20	100	NR	4.28	9.16	41
		700	415	53	100	NR	11.65	21.14	41

Legend for Table 4-18:
AP=armor piercing
API=armor-piercing incendiary
NR=not required

Notes:
¹ Area A applies to cone SDZ only.

w. Table 4–19 contains SDZ data for M903 .50 caliber SLAP small arms direct-fire ammunition.

Table 4–19
Surface danger zone data for M903 .50 caliber sabot light armor penetrator

Altitude (ft)	Impact media	Distance X (m)	Distance W (m)	Distance D (m)	Area A (m)	Area B (m)	Angle P (deg)	Ricochet vertical hazard (m)
0	Sand/Steel	8,625	1,130	1,074	NR	NR	47.34	1,130
1,000	Sand/Steel	8,885	1,155	1,101	NR	NR	47.34	1,155
2,000	Sand/Steel	9,145	1,180	1,128	NR	NR	47.38	1,180
3,000	Sand/Steel	9,405	1,205	1,155	NR	NR	47.39	1,205
4,000	Sand/Steel	9,665	1,230	1,182	NR	NR	47.40	1,230
5,000	Sand/Steel	9,925	1,255	1,209	NR	NR	47.42	1,255
6,000	Sand/Steel	10,185	1,280	1,236	NR	NR	47.43	1,280
7,000	Sand/Steel	10,445	1,305	1,263	NR	NR	47.44	1,305

x. Table 4–20 contains SDZ data for M962 .50 caliber SLAP–T small arms direct-fire ammunition.

Table 4–20
Surface danger zone data for M962 .50 caliber sabot light armor penetrator-T

Altitude (ft)	Impact media	Distance X (m)	Distance W (m)	Distance D (m)	Area A (m)	Area B (m)	Angle P (deg)	Ricochet vertical hazard (m)
0	Sand/Steel	9,560	1,240	1,001	NR	NR	48.00	1,240
1,000	Sand/Steel	9,870	1,270	1,025	NR	NR	48.00	1,270
2,000	Sand/Steel	10,180	1,300	1,049	NR	NR	48.01	1,300
3,000	Sand/Steel	10,490	1,330	1,073	NR	NR	48.02	1,330
4,000	Sand/Steel	10,800	1,360	1,098	NR	NR	48.03	1,360
5,000	Sand/Steel	11,110	1,390	1,122	NR	NR	48.04	1,390
6,000	Sand/Steel	11,420	1,420	1,146	NR	NR	48.04	1,420
7,000	Sand/Steel	11,730	1,450	1,170	NR	NR	48.04	1,450

y. Table 4–21 contains SDZ data for .50 caliber MK211, MK211–0/API–T small arms direct-fire ammunition.

Table 4–21
Surface danger zone data for .50 caliber MK211, MK211–0/API–T

Altitude (ft)	Impact media	Distance X (m)	Distance W (m)	Distance D (m)	Area A (m)	Area B (m)	Angle P (deg)	Ricochet vertical hazard (m)
0	Sand/Steel	7,955	1,075	530	NR	NR	49.48	1,075
1,000	Sand/Steel	8,104	1,100	528	NR	NR	50.26	1,100
2,000	Sand/Steel	8,325	1,125	526	NR	NR	51.02	1,125
3,000	Sand/Steel	8,515	1,150	524	NR	NR	51.76	1,150
4,000	Sand/Steel	8,700	1,175	522	NR	NR	52.49	1,175
5,000	Sand/Steel	8,885	1,200	520	NR	NR	53.20	1,200
6,000	Sand/Steel	9,075	1,225	518	NR	NR	53.89	1,225
7,000	Sand/Steel	9,260	1,250	516	NR	NR	54.56	1,250

z. Table 4–22 contains SDZ data for 20 mm small arms direct-fire weapons.

Table 4–22
Surface danger zone data for 20 mm small arms direct-fire weapons

Ammunition 20 mm	Impact media	Distance X (m)	Distance Y (m)	Distance W (m)	Area A (m)	Area B (m)	Angle P (deg)	Angle Q (deg)	Ricochet vertical hazard (m)
M55A2 TP	Earth	4,500	3,780	733	100 ¹	NR	25.74	33.20	357
	Water	4,500	3,500	737	100 ¹	NR	26.16	36.66	350
	Steel	4,500	4,053	1,025	100 ¹	NR	38.14	36.82	585
	Concrete	4,500	3,750	969	100 ¹	NR	34.12	37.78	509
M220 TP–T	Earth	3,940	3,340	581	100 ¹	NR	25.83	22.83	317
	Water	3,940	3,040	558	100 ¹	NR	26.08	30.96	311
	Steel	3,940	3,290	804	100 ¹	NR	36.66	47.76	513
	Concrete	3,940	3,260	765	100 ¹	NR	34.33	34.09	447
M56A3 HEI	Earth	4,250	3,940	771	156	156	26.89	34.54	403
	Water	4,250	3,980	864	156	156	27.21	40.82	396
	Steel	4,250	4,160	1,219	156	156	38.36	58.05	664

Table 4–22
Surface danger zone data for 20 mm small arms direct-fire weapons—Continued

Ammunition 20 mm	Impact media	Distance X (m)	Distance Y (m)	Distance W (m)	Area A (m)	Area B (m)	Angle P (deg)	Angle Q (deg)	Ricochet vertical hazard (m)
M246 HEITSD	Concrete	4,250	4,240	1,189	156	156	34.65	43.79	577
	Earth	4,230	3,537	685	156	156	26.73	39.83	360
	Water	4,230	3,316	716	156	156	25.81	35.87	354
	Steel	4,230	3,937	991	156	156	38.63	38.58	590
	Concrete	4,230	3,758	952	156	156	34.99	50.31	531

Legend for Table 4-22:

HEI=higher explosive incendiary

HEITSD=high explosive incendiary tracer self-destruct

NR=not required

TP=training practice

TP–T=training practice-tracer

Notes:

¹ Area A applies to cone SDZ only.

aa. Table 4–23 contains SDZ data for 30 mm small arms direct-fire weapons.

Table 4–23
Surface danger zone data for 30 mm small arms direct-fire weapons

Ammunition 30 mm	Impact media	Distance X (m)	Distance Y (m)	Distance W (m)	Area A (m)	Area B (m)	Angle P (deg)	Angle Q (deg)	Ricochet vertical hazard (m)
M788 TP	Earth	4,020	3,116	636	100 ¹	NR	24.93	40.37	311
	Water	4,020	3,252	730	100 ¹	NR	25.19	28.65	298
	Steel	4,020	3,631	1,023	100 ¹	NR	36.78	33.18	524
	Concrete	4,020	3,600	874	100 ¹	NR	30.66	35.59	451
M789 HEDP	Earth	4,122	3,305	654	275	275	25.37	39.65	318
	Water	4,122	3,263	746	275	275	24.71	34.53	302
	Steel	4,122	3,947	1,058	275	275	36.26	39.59	534
	Concrete	4,122	3,684	886	275	275	31.56	42.14	460

Legend for Table 4-23:

HEDP=high-explosive dual-purpose

NR=not required

Notes:

¹ Area A applies to cone SDZ only.

4–3. Small caliber dummy, drill, and inert ammunition

The dummy, drill, and inert (DDI) cartridges are designed to aid in easy identification of inert ammunition to prevent injury caused by any mix-up with live service ammunition during training. The DDI are completely nickel plated with the 9mm DDI having two holes drilled in the cartridge case, while the 5.56, 7.62, and .50 caliber DDI have fluted cartridge cases to aid tactile identification in darkness. For the Army, the nickel plated DDI will be the only DDI inert small caliber cartridges authorized for classroom training and weapon cycling functioning for weapon maintenance, or other situations when inert cartridges are needed.

Chapter 5 Grenades and Grenade Launchers

5–1. Hand grenades

a. *High explosive loaded type grenades.* These contain explosive charges that detonate after a short delay (3 to 5

seconds). Every precaution will be taken to prevent injury from blast, concussion, and fragment. For training purposes, fragmentation and offensive hand grenades will be thrown from a trench or barrier equivalent to a screen of sandbags 0.5 m (1.65 ft) thick. When throwing bays are used for protection, they will be built to a minimum height of 1.5 m (5 ft) high and 2.7 m (8.8 ft) wide or enough to accommodate one thrower and one assistant Range Safety Officer (ARSO). Bay height may be reduced to less than 1.5 m if approved by the installation commander. However, it must provide positive protection against high-velocity, low-angle fragments. (See FM 3–23.30 and TC 25–8 for other dimensions and additional information.) Throwing bays will be separated from adjacent bays by a distance of 20 m; if this requirement cannot be met, then throwing bays may be separated from one another by physical barriers (earthen berms, concrete walls, or wooden revetments) long and high enough to attenuate high-velocity, low-angle fragments. It is recommended that all throwing pits for live grenade training have knee walls at the rear of the bay. Knee walls provide the quickest and safest means of reacting to a dropped grenade. Knee walls should be 0.6 m (2 ft) high.

b. Firing conditions for fragmentation and offensive grenades.

(1) Personnel within the 150 m danger area when casualty-producing hand grenades are thrown shall wear, at a minimum, PPE Level 1 (Marine Corps), protective helmet and body armor (Army), and eye protection. Refer to table 2–2. Approved single hearing protection is required for all participating personnel when throwing bays are used. Approved single hearing protection is recommended for all personnel participating in tactical exercises.

(2) Safety clips on fragmentation and practice grenades will not be removed until immediately before the safety pin is removed. Once the safety pin has been pulled, the grenade will be thrown. No attempt will be made to reinsert the safety pin or tape the safety lever (spoon). The safety lever will not be released for any reason on HE grenades until the grenade exits the throwing hand.

(3) All personnel must be proficient in the safety precautions for handling and throwing grenades before live grenade training begins. Successful completion of practice grenade training (usually referred to as mock-bay, these pits will replicate the physical layout of live-bay pits) is mandatory prior to live grenade training.

(4) OICs, RSOs, and live-bay ARSOs for live grenade training events must be certified to perform these duties. Certification will include training detailing actions in the event of a dropped grenade, short throw, grenade thrown other than downrange, SDZ, control of observers, misfire/dud grenade procedures, arming, throwing techniques, and pre-live bay requirements. Marine Corps battalion/squadron commanders are responsible for establishing and maintaining a certification program for their OICs and RSOs commensurate to the assigned duties and responsibilities. RSOs and ARSOs must be qualified with the hand grenade prior to assuming their duties.

(5) HE grenades that fail to function (dud) will not be approached except by EOD personnel. During training, if a grenade fails to explode, the throwing of live grenades in any bay within the uninterrupted fragmentation radius of the dud grenade will cease. Dud grenades will be destroyed by EOD personnel only. Unauthorized personnel will not approach, move, touch, or handle dud grenades. All duds will be reported by the OIC to the range operations office (Army), range control office (Marine Corps).

(6) During demonstrations, fragmentation and blast/concussion type grenades will be thrown from a barricaded position so grenades burst at least 150 m from unprotected personnel (see fig 5–1).

(7) When direct viewing of hand grenade detonations within the 150 m danger area is required the following information is provided:

(a) Viewing positions will be constructed so as to provide positive protection from high-velocity, low-angle fragments and low-velocity high-angle fragments.

(b) Composite (laminated) viewing ports will be constructed using the following criteria or equivalent:

1. 10mm (.40 inch (in)) glass (outside).
2. 7mm (.28 in) polycarbonate.
3. 6mm (.24 in) glass.
4. 6mm (.24 in) polycarbonate.
5. 6mm (.24 in) glass.
6. 6mm (.24 in) polycarbonate.

(c) Alternatives:

1. Provide a single pane of UL 752 Level 1-, Level 2-, or Level 3- rated bullet-resisting laminated glass glazing (with a minimum total thickness of at least 1–3/16 inches). Also, as an alternative, two panes of other UL 752 Level 1-, Level 2-, or Level 3- rated bullet-resisting glazing types may be used provided each pane contains a minimum of 30 percent glass by thickness. In cases where the protected side of the glazing is made of a glass layer, the interior surface should have a spall shield/film applied to that surface by the manufacturer.

2. These criteria provide minimum essential one-time protection against worst case fragmentation detonated within 6 m of the viewing port. Additionally, 12.7mm (.50 in) or equivalent exterior polycarbonate protective sheet (scar shield) should be installed in front of the viewing port. The shield absorbs the majority of damage and is more easily replaced than the entire viewing port.

3. Live grenades will not be thrown into standing water, deep snow, or dense vegetation which would obscure the grenade (for example, deeper than 5 cm (2 in)).

4. When training with live grenades in a tire house, trench line, or like environment and a dud grenade is experienced, all activities within the structure or danger area will stop. Personnel will remain within a safe area for a minimum of 5 minutes and then evacuate the structure or area until EOD clears the dud.

5. Range cadre and commanders are cautioned that multiple employment of grenades in a training scenario significantly increases the difficulty of determining the actual number of grenades that detonated. Dud grenades may be activated by subsequent training, generating an unplanned detonation.

6. Simultaneous employment of multiple fragmentation grenades into a single impact point is prohibited, as a live grenade could be propelled into the "safe area" by the detonation of another grenade (Marine Corps).

7. The use of hand grenades during live-fire exercises shall conform to the provisions provided by chapter 17.

c. Firing conditions for chemical and incendiary hand grenades.

(1) Chemical grenades will not be held in the hand after the safety lever is released. The incendiary hand grenade may be taped or tied in place if the incendiary effect is desired at a specified location. In this case, safety pins will not be pulled from the grenade until the desired time of functioning. Remote safety pin removal is preferred.

(2) Burning type grenades (riot control, smoke, illumination, and incendiary) are ignited by pulling the safety pin and releasing the safety lever. After the safety pin has been pulled, the safety lever will not be released until the grenade exits the throwing hand. Once the safety lever is released, there is no way to stop the grenade from functioning. When the burning type grenade is fired in place, the firer will keep their face turned away from the grenade. After releasing the safety lever, the firer will quickly move at least 10 m away to avoid contact with incendiary particles and fumes emitted during burning.

(3) Personnel will be instructed on the proper method of holding the M25 bursting type, riot control grenade before commencing training exercises. The arming sleeve will remain depressed until the grenade is thrown. M25 grenades will not be thrown closer than 25 m to unprotected personnel.

(4) Burning type grenades burn oxygen. Standard protective masks filter particles but will not supply oxygen. Therefore, burning grenades shall not be used in enclosed or confined spaces (such as occupied tunnels) or in other confined spaces into which personnel will enter until those spaces are ventilated. Specific fuse burning delay times and functioning characteristics are in TM 9-1330-200-12 and TM 43-0001-29.

(5) Burning type 0-chlorobenzyl denemalononitrite (CS) grenades will not be fired closer than 10 m to other personnel or 50 m to spectators upwind.

(6) Hexachloroethane (HC) smoke grenade restrictions are the same as those for HC smoke pots. These grenades will ignite combustible materials and cause burns. A separation distance of at least 10 m should be maintained from burning grenades. Personnel will wear protective respirators or masks before exposure to any concentration of smoke produced by HC smoke grenades. (See chap 13 for detailed information concerning smoke hazards.)

(7) Burning particles of white phosphorous (WP) are frequently projected from the M15 and M34 grenades to a distance of 40 m from the bursting point. Therefore, M15 and M34 WP grenades should be thrown only on standard live grenade ranges during training as prescribed in FM 3-23.30. Trainers should consider use of protective cover when using the M15 and M34. White phosphorous particles cause serious, painful, slow-healing burns. Refer to FM 4-25.11 for appropriate first-aid measures.

(8) Direct viewing of thermite grenades will not be conducted due to the high potential of permanent eye damage.

d. M84 Stun Grenade. All personnel within 1.52 m (5 ft) will wear single hearing protection if employing 2 rounds per day. All personnel within this distance will wear double hearing protection if employing 3 to 41 rounds per day.

e. Surface danger zones.

(1) Surface danger zone requirements for hand grenades are provided in figure 5-1.

(2) Planning guidance for hand grenade ranges is in TC 25-8.

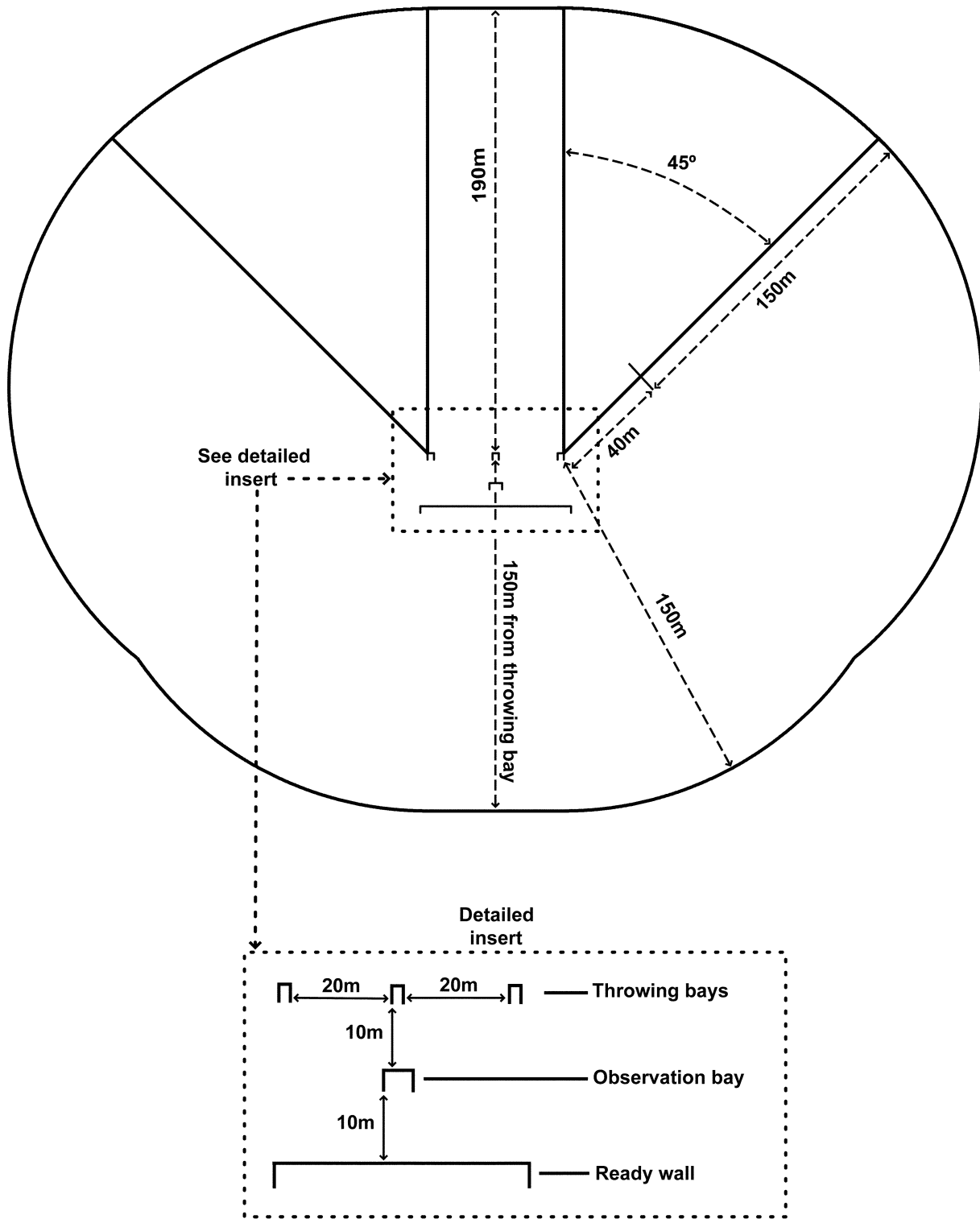

Figure 5-1. Surface danger zone for fragmentation and offensive hand grenades

5-2. Grenade launchers and grenade machine guns

a. General firing conditions.

(1) Personnel will be instructed in the proper use of grenade launchers and grenade machine guns and applicable safety precautions before firing with live ammunition.

(2) Protective helmet and body armor (Army) or PPE Level 1 (Marine Corps) will be worn when firing HE ammunition. Requirement for eye protection will be determined by the commander as part of the risk management process. Refer to table 2-2.

(a) Hazardous fragmentation from HE grenade ammunition may be experienced up to 165 m from the point of detonation. Appropriate HE no-fire lines will be established.

(b) Although the MK32, M79, M203, and M320 40 mm grenade launchers are designed to prevent accidental chambering of 40mm high-velocity ammunition, OICs and RSOs will ensure only low-velocity grenade cartridges are fired from MK32, M79, M203, and M320 grenade launchers.

(c) Single hearing protection will be worn within 2 m of firing these grenade launchers.

(d) Snow depth of 10cm (4 in) or more and standing water will increase the potential of 40 mm duds. These conditions must be considered prior to firing.

(e) Minimum target engagement for MK32, M79, M203, and M320 grenade launchers firing HE ammunition is 130 m or 165 m, depending on type of ammunition.

(3) All duds will be reported by the OIC to the range operations firing desk (Army), range control office (Marine Corps). When fired or launched, HE grenades cannot be cleared from an impact area, which must be designated as a dedicated, high-hazard impact area. Dedicated, high-hazard impact areas will be posted with signs to warn and keep out unauthorized personnel, and fenced off, if practical.

b. General firing precautions. General firing precautions for the MK19, MOD 3 grenade machine gun.

(1) Targets will be engaged only at ranges greater than 75 m with training practice (TP) ammunition.

(2) Targets will be engaged only at ranges greater than or equal to 310 m with HE ammunition.

(3) Firing through obstructions will be avoided.

(4) Gunners, crew members and other personnel at the firing position will wear protective helmet, eye protection, and body armor (Army) or PPE Level 1 (Marine Corps) at all times when firing HE ammunition. Refer to table 2-2.

(5) Range firing procedures and physical setup must be adequate to prevent HE rounds from impacting closer than 310 m from the firing position, firing vehicle, other vehicles, or personnel.

(6) Firing over open vehicle hatches is not authorized. Serious injury can result from burns caused by weapon flash or by expended or ejected cartridge cases striking personnel.

(7) Approved single hearing protection and eye protection is required for all personnel within the noise hazard contour of a 20 m radius of the weapon system.

(8) Daily exposure limit within the noise hazard contour is 1,000 rounds per day.

(9) Army personnel recovering dud M918 40mm TP projectiles will follow the procedures outlined in TB 9-1310-251-10. The use of protective goggles or face shield, gloves, and tongs while handling M918 TP rounds is mandatory. Marine Corps EOD personnel recovering the same munitions will follow procedures outlined in EODB 60 series publications.

c. Static firing restrictions for vehicle mounted machine gun. Static firing restrictions for vehicle mounted machine gun, MK19, MOD 3 grenade machine gun.

(1) A gunner's quadrant and/ or MK64, MOD 7 mount depression stop will be used to keep the minimum elevation above 30 mil when firing.

(2) M998 High Mobility Multipurpose Wheeled Vehicle (HMMWV) interim squad carrier:

(a) Soft tops must be installed over the driver and passenger compartments for safe operation of the vehicle when firing the MK19.

(b) Visual and physical inspection of the adaptive engineering team collar-mounting bolts must be performed prior to, during, and after firing operations. All bolts must be present with nuts firmly tightened prior to firing.

(3) M113 and M106 series armored carriers:

(a) Firing over open hatches is prohibited.

(b) Driver's hatch must be closed when firing off the left side, forward, or off the right side of the vehicle, or when personnel or objects in hatch areas are forward of the weapon muzzle.

(4) M88A1 Heavy Equipment Recovery Combat Utility Lift and Evacuation System (HERCULES) medium-tracked recovery vehicle:

(a) Operator and mechanic hatches must be closed when firing off the left side, forward, or off the right side of the vehicle.

(b) Personnel doors on the vehicle sides may remain open during firing forward or to the rear, but will be closed when firing to the left or right side of the vehicle.

d. *Moving firing restrictions for machine gun.* Moving firing restrictions for the MK19, MOD 3 grenade machine gun to preclude unintentional impacts of HE and high explosive dual purpose (HEDP) ammunition at ranges less than 310 m —

(1) Restrict speeds to not greater than 20 kilometers (km) per hour (12 miles per hour (mph)) when firing from the M1025/1026 HMMWV armament carrier and the M998T interim squad carrier over paved and improved roads that are in good condition, and not greater than 10 km per hour (6 mph) over rough roads, trails, and cross-country.

(2) Restrict speeds to not greater than 20 km (12 mph) when firing from the M113 and M106 family of armored carriers, and the M88A1 tracked recovery vehicle over roads, trails, and cross-country.

e. *Surface danger zone.*

(1) SDZ requirements for MK32, M79, M203, and M320 grenade launchers are provided in table 5–1 and figure 5–2. A minimum 6 m separation distance is required between firing positions. Cartridge M433 requires an Area A and B of 165 m. All other MK32, M79, M203, and M320 HE cartridges require 130 m as illustrated in figure 5–2.

(2) SDZ criteria for the MK19, MOD 3 grenade machine gun are shown in table 5–2 and figure 5–3. Minimum target engagement range for HE cartridges is 310 m.

Table 5–1
Surface danger zone dimensions for MK32, M79, M203, and M320 40mm grenade launcher

Cartridge	Impact media	Distance X (m)	Area A (m)	Area B (m)	Vertical hazard (m)
M381 HE ¹	Earth	470	130	130	216
	Armor	470	130	130	216
M433 HEDP ¹	Earth	470	165	165	216
	Armor	470	165	165	216
M781 ¹ , M407A1 TP ¹	Earth	470	NR	NR	216
	Armor	470	NR	NR	216
M576 Multi Projectile	Earth	85	NR	NR	75
	Armor	85	NR	NR	75
M713, 715, 716 Smoke	Earth	470	NR	NR	216
	Armor	470	NR	NR	216
M661, M662, M583A1, M992 Illumination	N/A	470	NR	NR	216
		470	NR	NR	216
M651E1 CS ²	Earth	470	NR	NR	216
	Armor	470			

Legend for Table 5-1:

N/A=not applicable

NR=not required

Notes:

¹ Minimum target engagement range is 75 m for training practice, 130 m for all others except M433 which is 165 m.

² For the use of 0-chlorobenzyl denemalononitrite (CS) see chapter 13.

Table 5–2
Surface danger zone dimensions for MK19, MOD3 40mm grenade machine gun

Cartridge	Impact media	Distance X (m)	Distance Y (m)	Area W (m)	Area A (m)	Area B (m)	Vertical hazard (m)	Angle P (deg)	Angle Q (deg)
M383 HE	Earth	2,095	1,250	167	310	310	See note	23	15
	Armor	2,095	1,250	471	310	310			
M385A1 TP	Earth	1,984	1,250	167	NR	NR	See note	23	15
	Armor	1,984	1,250	471	NR	NR			
M430 HEDP	Earth	2,037	1,250	167	310	310	See note	23	15
	Armor	2,037	1,250	471	310	310			
M918 TP	Earth	2,095	1,250	167	NR	NR	See note	23	15
	Armor	2,095	1,250	471	NR	NR			

Table 5-2
Surface danger zone dimensions for MK19, MOD3 40mm grenade machine gun—Continued

Cartridge	Impact media	Distance X (m)	Distance Y (m)	Area W (m)	Area A (m)	Area B (m)	Vertical hazard (m)	Angle P (deg)	Angle Q (deg)
MK281 MOD 0 TP	Earth Armor	2,200	1,250	167	NR	NR	See note	23	15
		2,200	1,250	471	NR	NR		60	28
XM1001 Canister	Earth Armor	1,750	1,743	370	NR	NR	See note	35	25
		1,750	1,743	370	NR	NR		35	25

Legend for Table 5-2:

NR=not required

Notes:

¹ Use the sum of the values of Area W and Area A (if applicable) until validated test data is available.

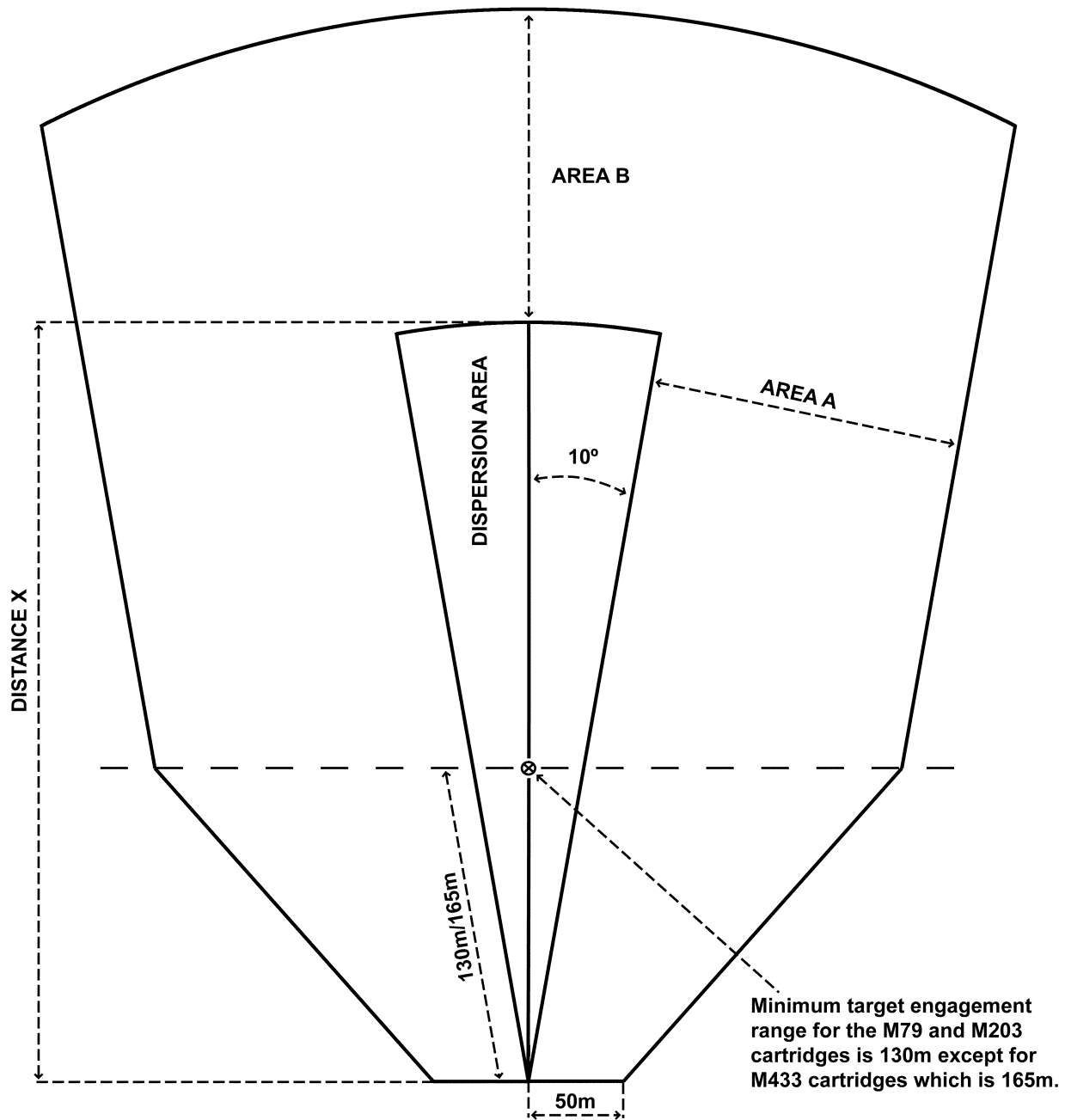

Notes:

- ¹ Prohibit cross-line firing when using multiple firing points.
- ² Maximum range (470 m) may be reduced when positive elevation control devices are used to limit range to impact distance.
- ³ Area A and B for the M433, HEDP is 165 m.
- ⁴ TP ammunition does not require Areas A or B.

Figure 5-2. Surface danger zone for firing MK32, M79, M203, and M320 grenade launchers

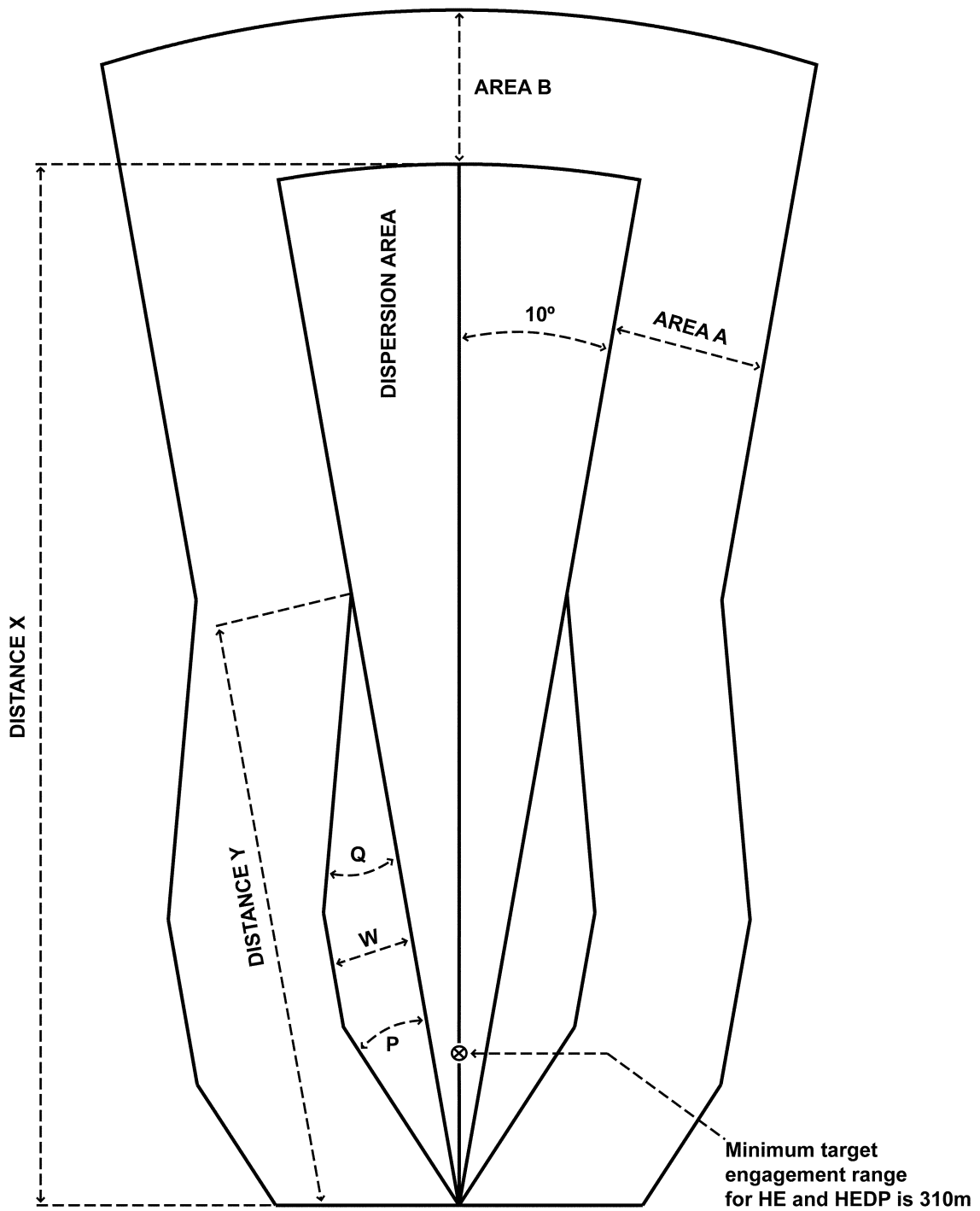

Figure 5-3. Surface danger zone for the MK19, MOD3 40mm grenade machine gun

Chapter 6 Antitank Rockets

6-1. Firing conditions

a. General.

(1) All loading and unloading for separate loading rockets (for example, 35mm training practice rocket and 66mm M74 incendiary rockets) will be on the firing line with the muzzle pointed downrange. Procedures and precautions in TM 3-23.25 and appropriate TMs will be observed in all preparation and firing operations.

(2) Personnel will not stand or have any portion of the body directly in front of or behind a loaded rocket launcher.

(3) Before firing, the SDZ to the rear of the launcher (Area F) will be cleared of personnel, materiel (including expended cartridge cases), and readily combustible vegetation. Area F for antitank rockets is a cone with the apex at the breech and radius corresponding with a rearward extension of the rocket target line.

(4) The use of manned target vehicles is prohibited when firing HE or high-explosive anti-tank (HEAT) ammunition. Moving target vehicles must be operated by remote control. Unprotected operating personnel shall be located outside the SDZ.

(5) Approved single hearing protection will be worn by personnel within 390 m of the firing point when firing antitank rockets. Approved single hearing protection will be worn by personnel within 500 m of the firing point when firing HE, HEAT, TP, smoke and illumination from the multi-role anti-armor antipersonnel weapons system (MAAWS). The gunner and all other personnel within a 100 m radius of the MAAWS must wear properly inserted foam earplugs as well as properly fitting ear muffs (double hearing protection).

(6) Gunners and other personnel within 20 m will wear personal protective gear such as improved body armor (IBA), ballistic eyewear, and helmets. Sleeves should be down and collars up. For the Marine Corps, a minimum PPE Level 1 must be worn (see table 2-2). Eye protection is encouraged when firing shoulder-launched multipurpose assault weapons (SMAW).

(7) During training with the SMAW, the gunner and assistant gunner are authorized to fire only five rounds per day because of sound pressure levels.

(8) All personnel are required to wear approved hearing protection when firing the M72AS light anti-tank weapon (LAW) training system.

b. Special firing conditions.

(1) SMAW-common practice round (CPR) HX-07 Areas A and B are not required.

(2) All personnel within 100 m of the SMAW launcher will wear, at a minimum, PPE Level 1, Marine Corps only. Eye protection is encouraged. Refer to table 2-2.

(3) For SMAW MK80 novel explosive (SMAW NE) (DODIC HA34), SMAW-MK6 high explosive anti-armor assault (HEAA) (DODIC HX06), SMAW-MK3 HEDP (DODIC HX05), and SMAW-MK7 CPR (SMAW) (DODIC HX-07), danger zone occupation could result in fatalities or serious casualties including severe burns, eye damage, or permanent hearing loss. The hazards are base plate fragments, debris, fireball, high noise levels, and overpressure.

(4) When the M72 LAW is fired in temperatures below freezing, all back blast areas (Area F) will be doubled. Operating personnel should wear approved face protection during firing.

(5) Extending the M72 weapon system too slowly can result in a failure to cock the weapon.

(6) All M72AS 21mm training system weapons will be visually inspected for damage before firing. Damaged weapons will be destroyed per standard EOD procedures.

(7) Rockets, MAAWS, or the M136 AT4 shoulder-launched munition will not be fired from within buildings unless fired in accordance with ATTP 3-06.11 or within 50 m of a vertical or nearly vertical backstop, barrier, or obstacle due to the risk of debris ricochets.

(8) Prone or foxhole firing of HE AT4 (M136) is not authorized. In training, an individual may fire one round from the sitting position or three rounds from the standing or kneeling positions in a 24-hour period.

(9) Prone firing of HE or TP ammunition in the MAAWS is not authorized due to overpressure hazards.

(10) The firing of antitank rockets over unprotected troops from a moving vehicle or aircraft is not authorized.

(11) For HE ammunition, limit the number of daily firings by any individual (gunner or personnel within 20 m) to four. There is no limit for the M72AS 21mm LAW training system.

6-2. Surface danger zone

a. Surface danger zone requirements including minimum target engagement distances for antitank rockets are in tables 6-1 and 6-2 and figures 6-1 and 6-2.

Table 6-1
Antitank rocket launcher surface danger zone criteria, in meters

Weapon	Area A	Area B	Minimum range to impact ¹	Distance X ²	Area F ³	
					Danger area	Caution area
66mm HEAT, M72A2	250	250	75	1,000	40	25
66mm Trainer M72AS 21mm sub-caliber	N/A	N/A	75	1,000	50	N/A
66mm HEAT M72A 4,5,6,7, and 9	250	250	75	1,400	40	30
66mm incendiary, M74	100	100	50	1,000	40	38
35mm sub-caliber, M73	100	100	50	1,150	40	25

Legend for Table 6-1:

HEAT=high explosive anti-tank

N/A=not applicable

Notes:

¹ Minimum range to impact (minimum target distance) may be reduced 60 percent when firing non-explosive warhead from unprotected positions or explosive warhead from protected positions.

² Distance X may be reduced if there is steeply rising terrain behind the target or overhead baffles and positive controls are used to limit elevation of the launcher at the firing position. A formal deviation must be approved to reduce Distance X. For the 35mm M73, see table 6-2.

³ When firing from the prone position, the gunner's lower body shall be 45 degrees away from the back blast area.

Table 6-2
Maximum ranges at various quadrant elevations for the 35 mm M73 practice rocket

Elevation (deg)	Range (m)	Max Ord (m)
5	343	8
10	591	30
15	776	62
30	1,082	203

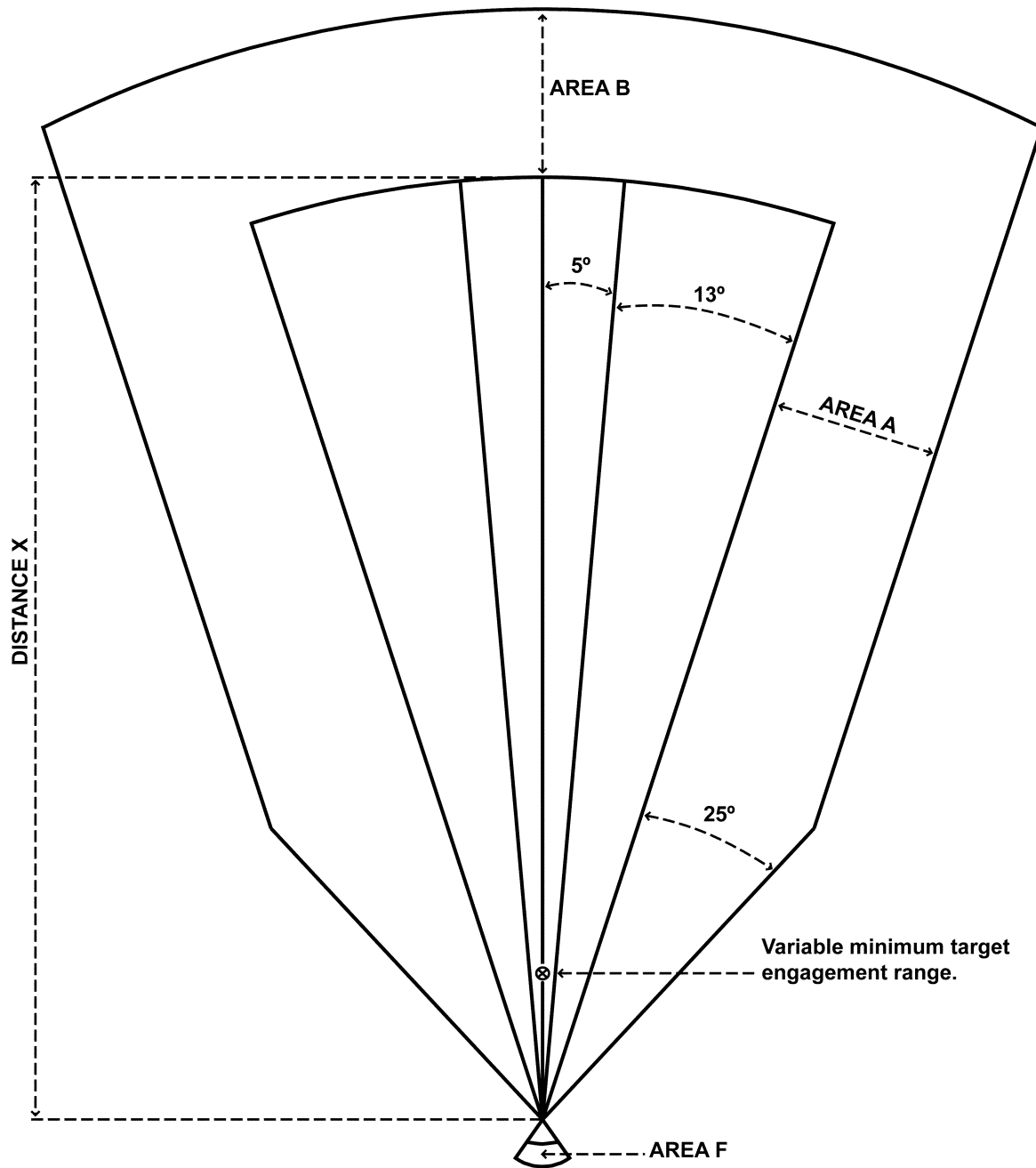

Figure 6-1. Surface danger zone for firing rocket launchers

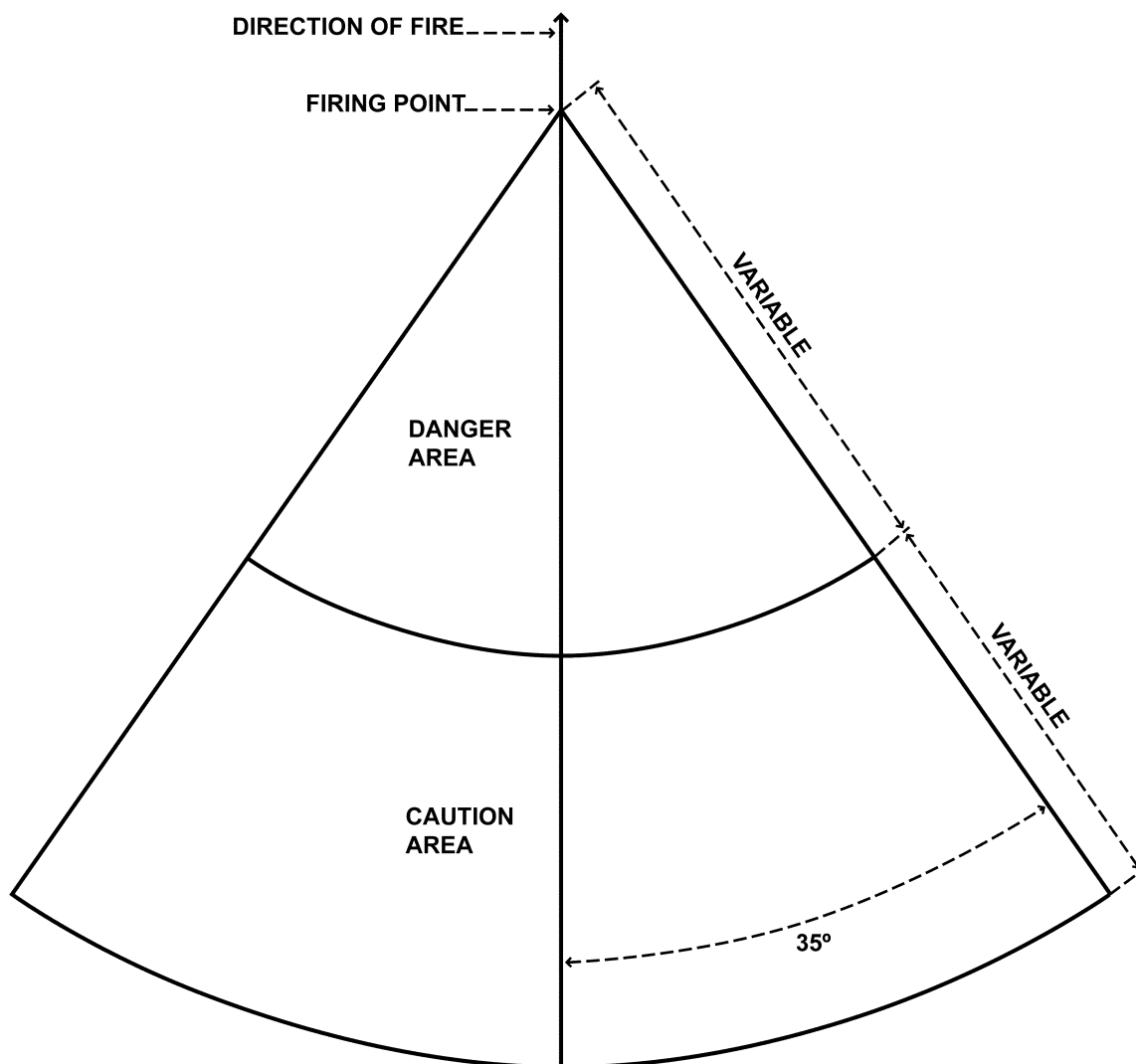

Figure 6-2. Surface danger zone, Area F, for firing rocket launchers

b. SDZ requirements for MAAWS are in table 6-3 and figures 6-3 and 6-4.

Table 6-3
Multi-role anti-armor antipersonnel weapon systems surface danger zone criteria, in meters

Type	Distance X	Minimum range to impact ¹	Ricochet angle (deg)	Area A	Area B	Area F ² danger area ³	Area F ⁴ caution area
HE	2,600	250	13	400	400	40	60
HEAT	3,200	50	38	150	150	40	60
HEDP	2,000	150	12	330	330	40	60
TP	3,200	50	13	100	100	40	60
Smoke	2,600	150	13	150	150	40	60
Illumination ⁵	2,900	N/A	N/A	100	100	40	60

Table 6-3
Multi- role anti-armor antipersonnel weapon systems surface danger zone criteria, in meters—Continued

Type	Distance X	Minimum range to impact ¹	Ricochet angle (deg)	Area A	Area B	Area F ² danger area ³	Area F ⁴ caution area
7.62mm ⁶	4,100	N/A	5	100	N/A	N/A	N/A

Legend for Table 6-3:

- HE=high explosive
- HEAT=high explosive anti-tank
- HEDP=high explosive dual purpose
- N/A=not applicable
- TP=target practice

Notes:

¹ May be reduced 60 percent when firing non-explosive projectiles from unprotected firing positions or explosive projectiles from protected positions.

² Area F is a 90 degree angle (45 degrees left and right) of rearward extension of launcher target line.

³ Danger area occupation could result in fatalities or serious casualties, including severe burns or permanent hearing loss. The hazards are base plate fragments, debris, fireball, high noise levels, and overpressure.

⁴ Caution area is an extension of the primary danger zone. Occupation of this area could also result in severe casualties due to back blast, debris, high noise levels, eye injuries, and possible base plate fragments. Primary danger area and caution area are conditions that may not be modified.

⁵ Not a direct-fire round. Use figure 6-3 to construct SDZ.

⁶ Use SDZ data from chapter 4.

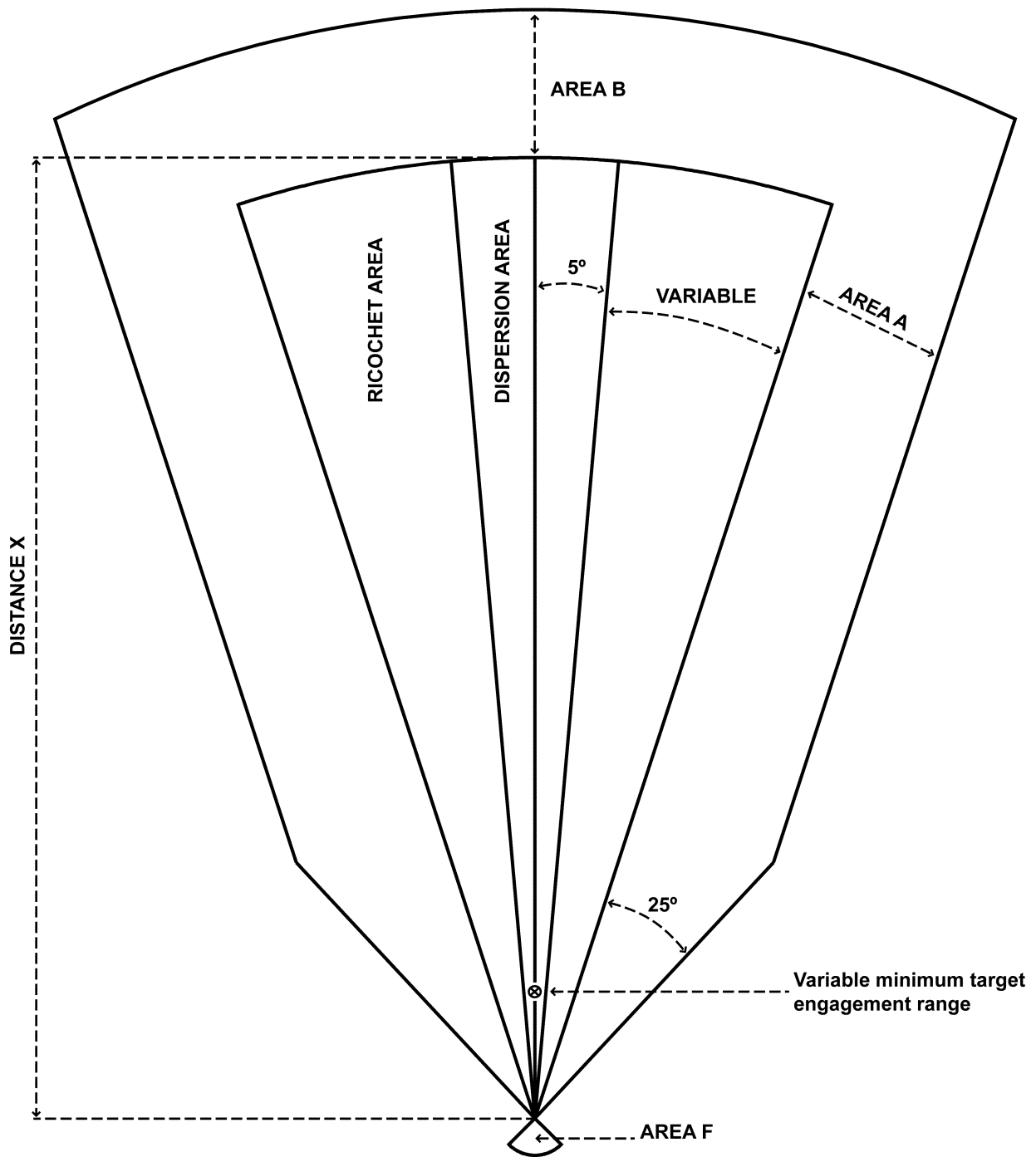

Figure 6-3. Surface danger zone for firing multi- role anti-armor antipersonnel weapon systems

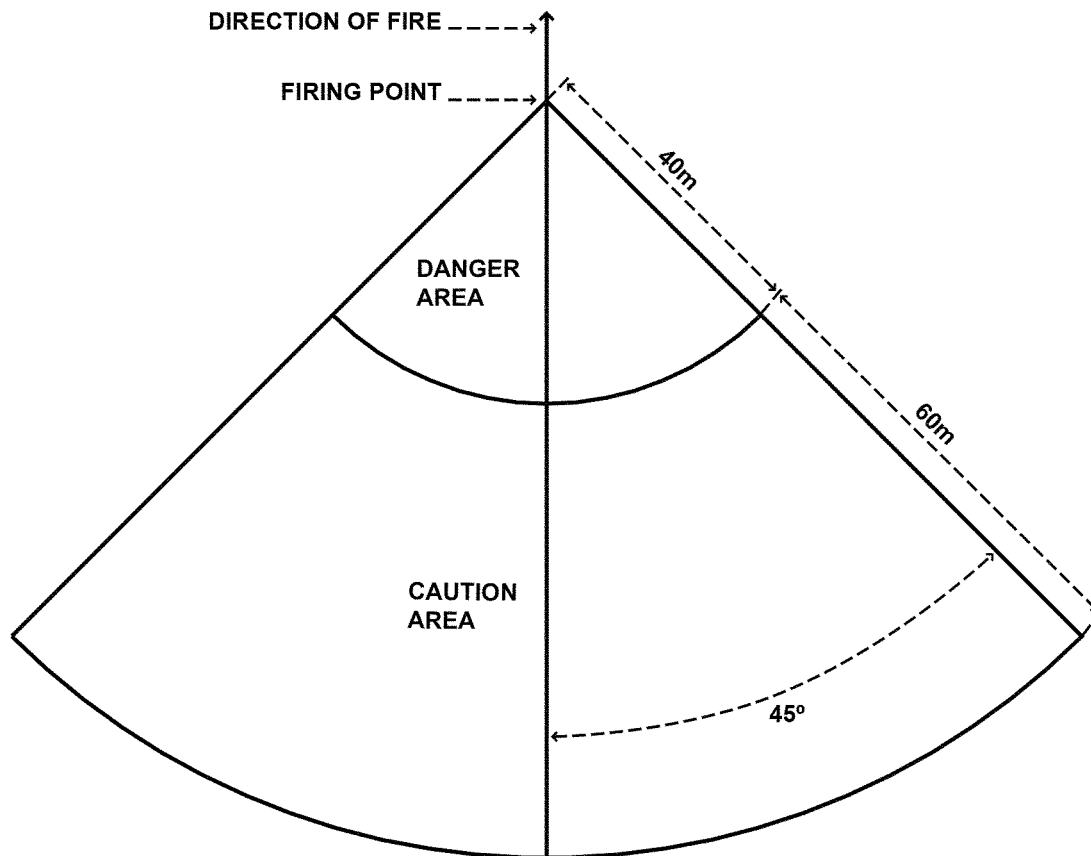

Figure 6-4. Surface danger zone, Area F, for firing multi- role anti-armor antipersonnel weapon system

c. SDZ requirements for the M136 AT4 are in table 6-4 and figures 6-5 and 6-6.

Table 6-4
M136 AT4 surface danger zone criteria, in meters

Type	Distance X	Minimum range to target	Area A	Area B	Area F	
					Danger area ¹	Caution area ²
84mm ³ HEAT M136	2,100	50 ³	227	488	5	95
9mm Trainer, M939	1,600	N/A	N/A	N/A	N/A	N/A

Legend for Table 6-4:

N/A=not applicable

Notes:

¹ Danger area occupation could result in fatalities or serious casualties including severe burns, eye damage, or permanent hearing loss. The hazards are base plate fragments, debris, fireball, high noise levels, and overpressure.

² Caution area is an extension of the primary danger area. Occupation of this area could also result in severe casualties due to back blast, debris, high noise levels, and possible base plate fragments. Primary danger area and caution area are conditions that may not be modified.

³ Increased dud rates may occur when firing HE (M136) at impact angles of 10 degrees or less.

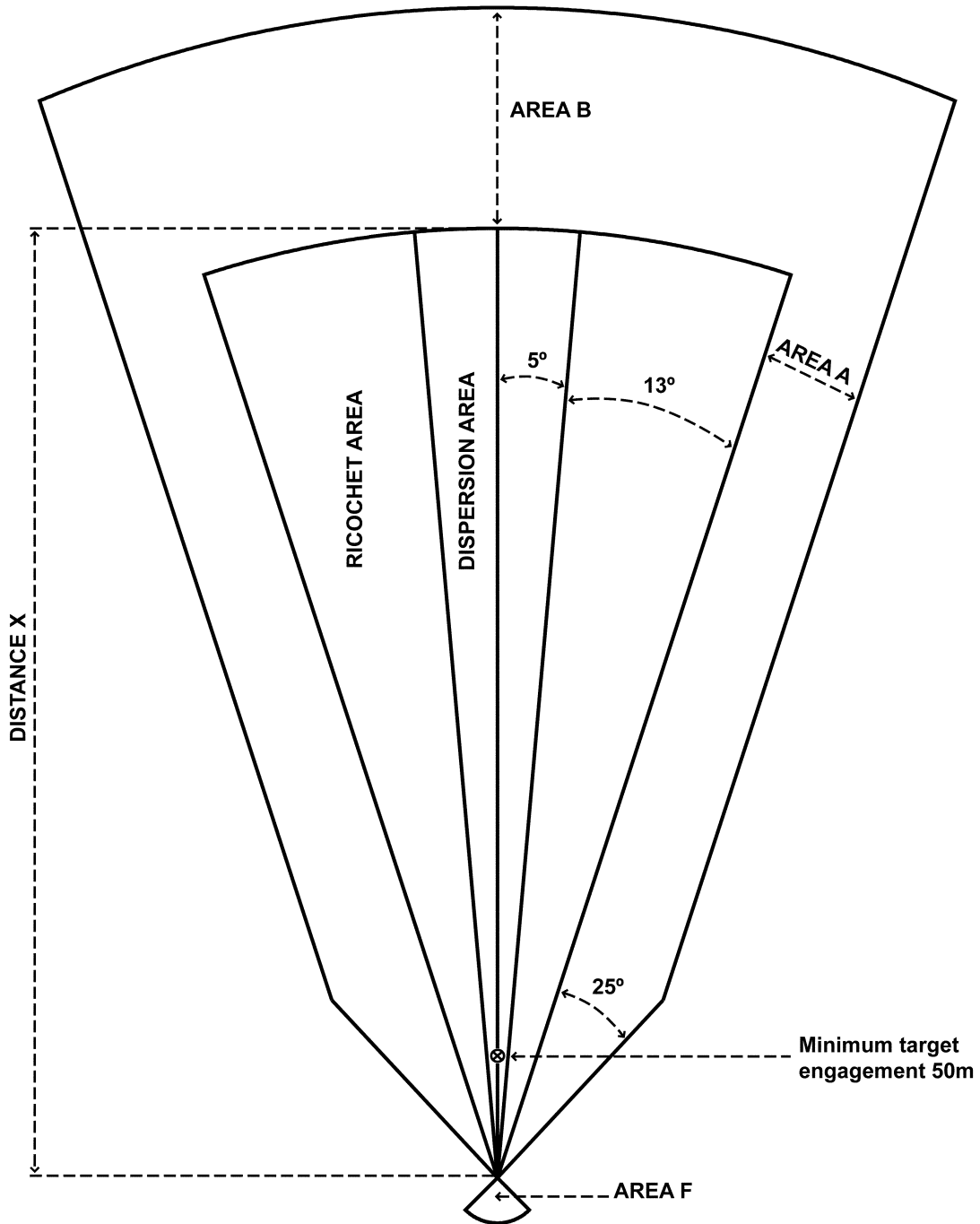

Figure 6-5. Surface danger zone for firing AT4

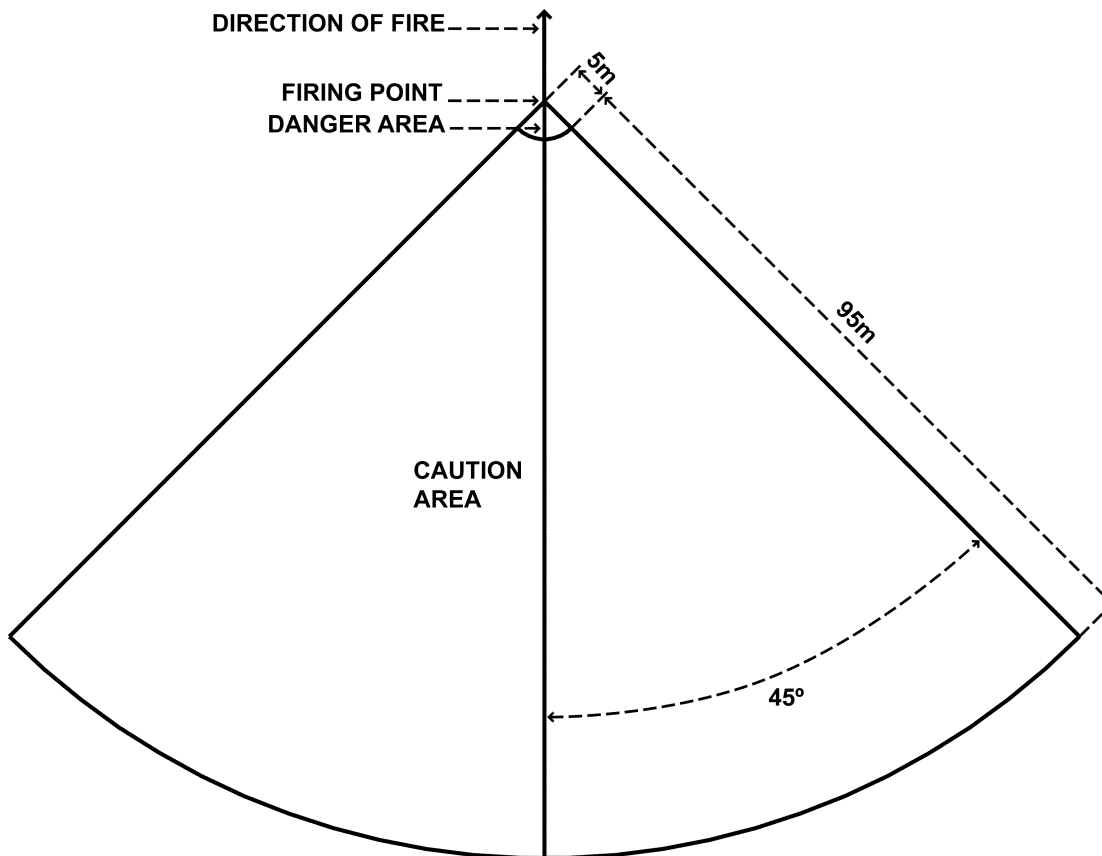

Figure 6-6. Surface danger zone, Area F, for firing AT4

- d. SDZ requirements for SMAW-NE are in table 6-5 and figures 6-7 and 6-9.
- e. SDZ requirements for SMAW-HEAA, -HEDP, and the -CPR are in table 6-5 and figures 6-8 and 6-9.

Table 6-5
Shoulder-launched multipurpose assault weapon surface danger zone criteria, in meters

Type	Distance X	Minimum range to target	Area A	Area B	Area F	
					Danger area	Caution area ¹
SMAW-NE HA34	2,460	100	250	250	30	70
SMAW- HEAA HX06	2,500	100	500	500	30	60
SMAW- HEDP HX05	2,500	100	250	250	30	60
SMAW- CPR HX07	2,500	100	N/A	N/A	30	60

Legend for Table 6-5:

N/A=not applicable

Notes:

¹ Caution area is an extension of the primary danger area. Occupation of this area could also result in injuries due to back blast, debris, high noise levels, and possible base plate fragments. Primary danger area and caution area are conditions that may not be modified.

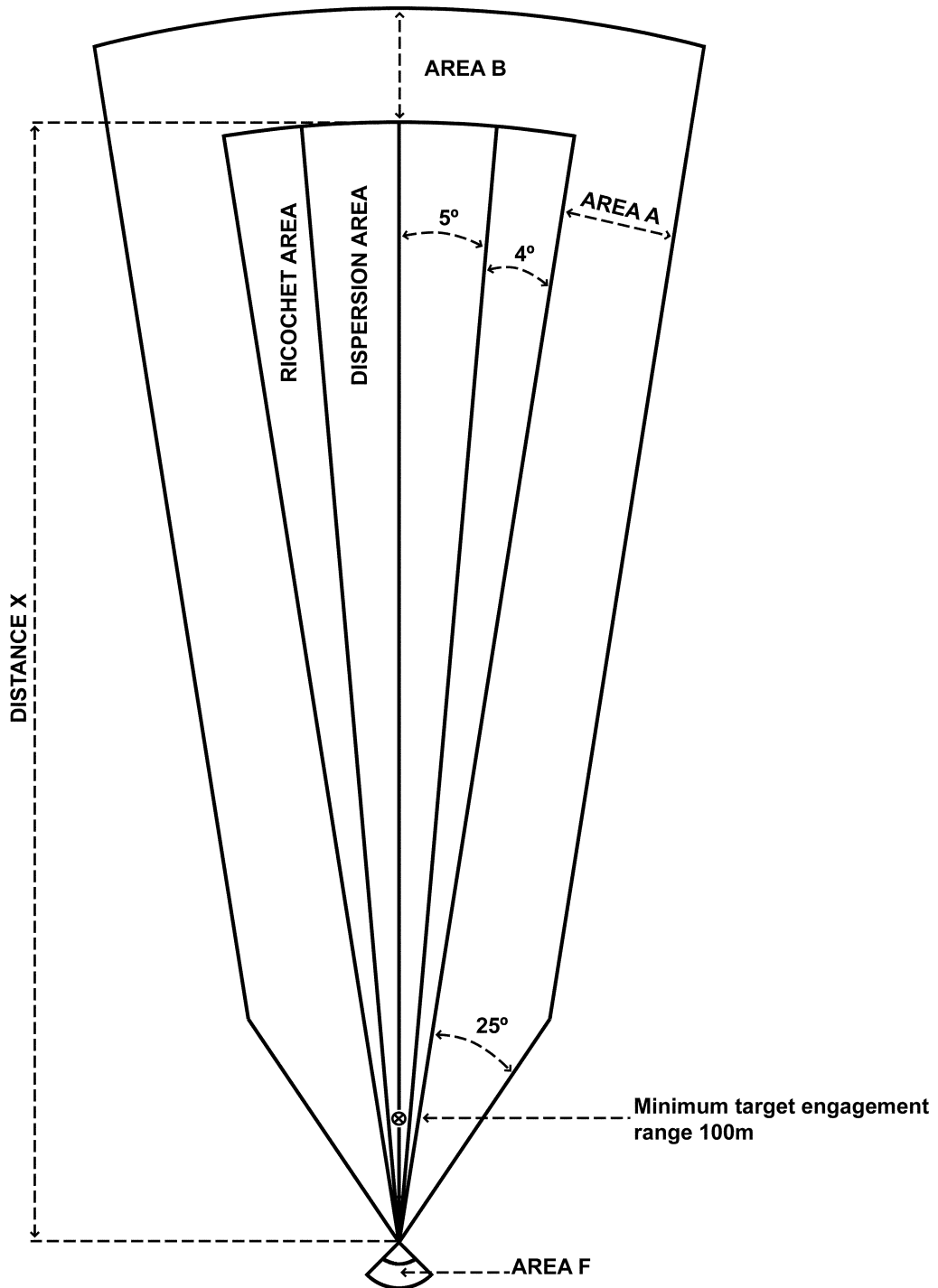

Figure 6-7. Surface danger zone for firing MK 80 SMAW-NE

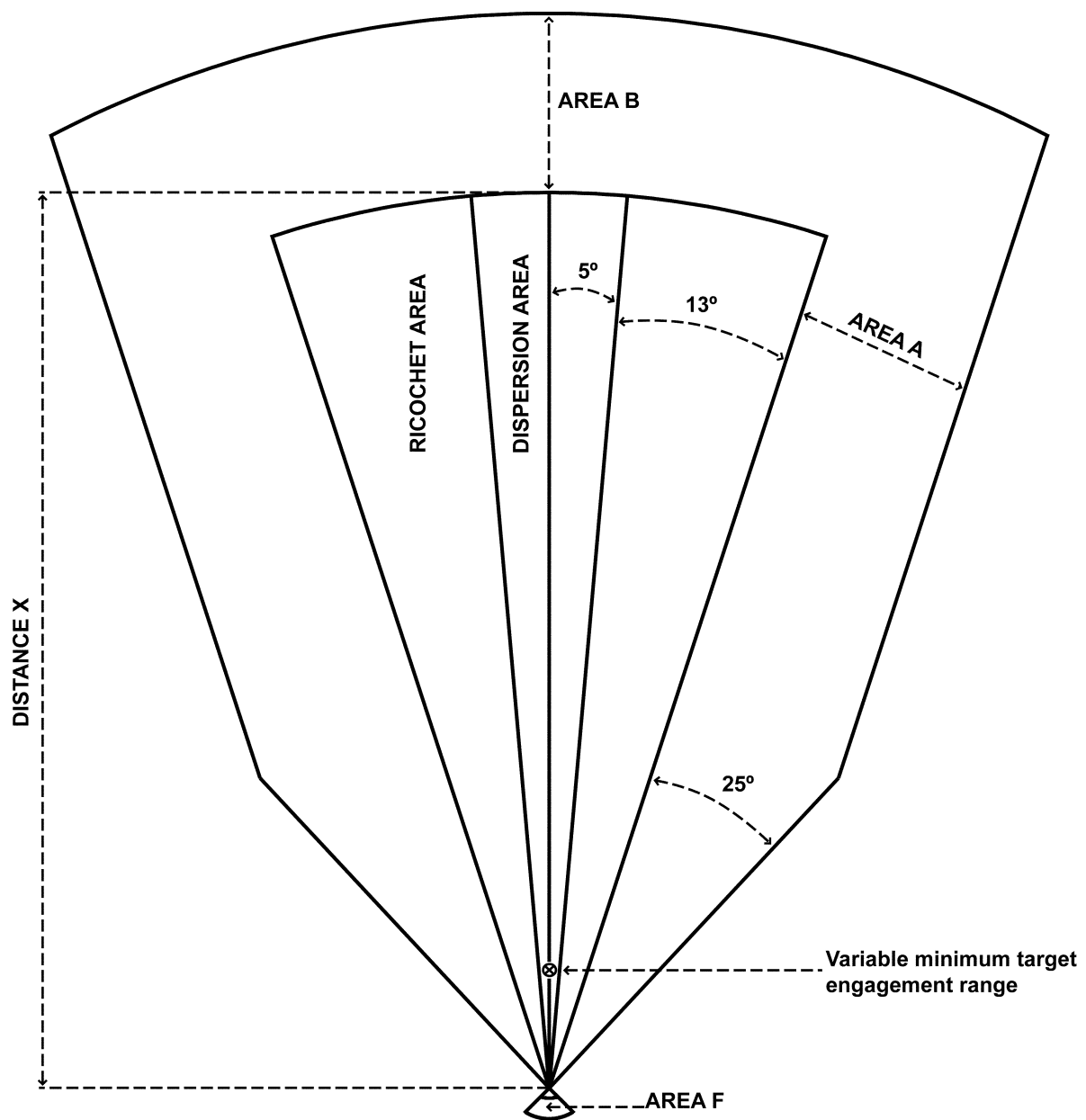

Figure 6-8. Surface danger zone for firing SMAW-HEAA, -HEDP, and common practice round

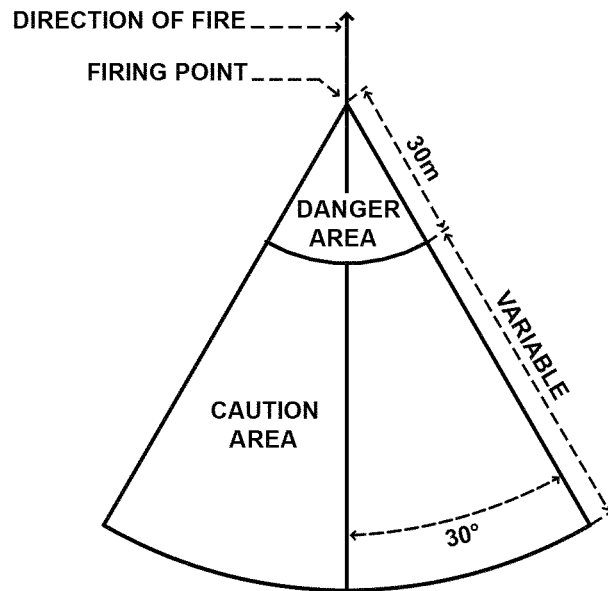

Figure 6–9. Surface danger zone, Area F, for firing SMAW–NE, –HEAA, –HEDP, and common practice round

f. Area F extends rearward of the launcher firing point at 90 degree (45 degree left and right) for the M72A2 and 70 degree (35 degree left and right) for M72A 4, 5, 6, and 7.

g. Area F consists of two primary areas known as danger area and caution area (except for the M72AS, which has only a danger area).

h. The vertical hazard of 950 m will be used when firing all HE antitank rockets.

Chapter 7 Antitank Guided Missiles

7–1. BGM–71 and BTM–71 series tube launched, optically-tracked, wire-guided missiles

a. Firing conditions.

(1) Before firing any TOW missile, the entire SDZ will be cleared of all non-mission-essential personnel. Essential range safety personnel such as road guards, gate guards, and/or range personnel conducting administrative duties, and so forth, shall be allowed within the SDZ at pre-established locations approved by the installation RMA (Army), RCO (Marine Corps).

(2) TOW missile firings must be accomplished within predetermined boundaries. The installation RMA (Army), RCO (Marine Corps) will ensure that an adequate SDZ exists along the missile target line (MTL) from each anticipated launch position within the predetermined boundaries.

(3) Procedures and precautions in appropriate FMs and TMs will be observed in all preparation and firing operations.

(4) Only those personnel actively engaged in firing and controlling TOW missiles as specified in appropriate FMs and TMs will be permitted in the SDZ. Participating personnel directly associated with but not actively engaged in the firing of TOW missiles may be located at protected sites within Area H, such as behind earthen berms.

(5) Personnel will neither stand nor permit any part of their body to be directly behind or in front of the TOW launcher while a missile is in the launch tube.

(6) TOW missiles should not be fired from any position which will permit the guidance wire to contact electrical power lines or the high power portion of electrically operated targetry. Commanders may deem it mission essential to fire at electrically powered targets where guidance wires may come in contact with the high powered portion of electrically-operated targets. However, the firing commander must first apply a thorough risk management process and have it approved by the installation RMA (Army), RCO (Marine Corps) prior to firing.

(7) For moving targets, TOW missiles should be launched within the left and right limits established by the

movement of the target. Missile impact should be as near to the original missile-to-target-line as possible. Large deflection divergences during flight should be avoided.

(8) TOW missiles will not be fired from within buildings or within 100 m of any vertical or nearly vertical backstop.

(9) The range will be inspected after TOW firing activities to ensure, to the maximum extent possible, that all guidance wires are removed from the training complex unless approval is granted from installation RMA (Army), RCO (Marine Corps) to abandon wires in place. Recovery of guidance wires will be made by ground personnel. Aircraft will not be used to remove guidance wires. The senior commander (Army)/installation commander (Marine Corps) will determine whether guidance wires will be recovered from dedicated and high hazard impact areas. Access to installation training complexes where command link guidance wires are used will be at the authorization of the installation RMA (Army), RCO (Marine Corps).

(10) Modification of Area I is not authorized. Occupation of Area I by unprotected personnel is prohibited.

(11) All missiles should be tested using the missile test set as part of the overall system pre-fire checks. This will identify the majority of missiles with a potential for operational failures.

(12) For the Marine Corps, participating personnel not in Area F but within a rectangle 100 m to either side and 200 m to the rear of the TOW firing point will wear a minimum of PPE Level 1, as referenced in table 2-2.

(13) For the Marine Corps, all firings of the TOW missile require the use of the Kevlar protective blanket except when TOW missiles are fired from the Light Armored Vehicle-Anti-Tank variant when all personnel are either within the protective hull of the vehicle or clear of the launch position by 75 m when missile firing is initiated.

(14) Aerial TOW firing and WDZ information is contained in chapter 11.

b. Surface danger zone.

(1) The SDZ for basic TOW, practice TOW, Improved TOW (ITOW), TOW 2, TOW 2A, TOW 2B, TOW 2B AERO and TOW 2BB (Bunker Buster) missiles firing at fixed and moving targets are illustrated in figure 7-1. This figure represents a 1:1,000,000 (10^{-6}) (47 degrees) probability of a missile fly-out/hazardous fragment escaping the SDZ. Figure 7-1 also contains information for a missile fly out/hazardous fragment escapement of 1:100,000 (10^{-5}) (45 degrees), 1:10,000 (10^{-4}) (38 degrees), and 1:1,000 (10^{-3}) (30 degrees). The SDZ is based on the maximum ballistic range for TOW variants since there is no provision for command destruct. For danger zones with a greater risk of missile fly-out/hazardous fragment escapement than 1:1,000,000 (10^{-6}), an approved deviation in accordance with chapter 1 of this pamphlet is required. Required distances (Distance X) for ground firings of the different TOW models are given in table 7-1.

(2) Area F is the danger area extending to the rear of the launcher (see fig 7-2). For ground firings, Area F is divided into a primary danger area and two caution areas.

(a) The primary danger area is a 90 degree included angular cone (45 degree on each side of the rear of the bore axis with a radius of 50 m) and with the apex of the cone centered at the rear of the missile launcher. Serious casualties or fatalities are likely to occur to any personnel in the primary danger area during firing. The hazards are launch motor blast, high noise levels, overpressure, and debris.

(b) Caution Area 1 is an area extending radially from each side of the primary danger area to the firing line with a radius of 50 m. Permanent hearing damage could occur to personnel in this area during firing. Approved hearing protection will be worn by all personnel occupying this area. The hazards are high noise levels and overpressure.

(c) Caution Area 2 is an extension of the primary danger area with the same associated hazards and personnel protection required. The radius of this area is 75 m.

(d) For the Army, at least single hearing protection will be worn by all personnel within the rectangle 100 m to either side and 200 m to the rear of the TOW firing point.

(3) Area H, a circular sector to the rear of the launch position, is established as an additional buffer zone to protect personnel from the hazards of high velocity fragments and missile debris resulting from detonation of the HE warhead during an "eject only" event (ballistic trajectory upon failure of the flight motor to ignite once the missile has exited the launcher). Each "eject only" event for TOW, Improved TOW, TOW 2, TOW 2A, TOW 2B AERO, and TOW BB is expected to produce about 100 fragments with a maximum range of 1,300 m and one slug with a maximum range of 3,200 m. The maximum fly-back range for TOW 2B is expected to be 1,000 m, and one slug is expected to travel 1,600 m. Modification of Area H is authorized by deviation. Area H is not required for inert warheads or for HE warheads equipped with missile ordnance inhibit circuits identified by U.S. Army Aviation and Missile Command for the Army or Marine Corps Systems Command for the Marine Corps. These missiles will encompass all Missile Ordnance Inhibit Circuit (MOIC), MOIC Enhancement (MOICE), Improved MOIC (IMOIC), and Digital MOIC (DMOIC) circuitry.

(4) Area I is a circular sector immediately in front of the launcher position. It is constructed by drawing an arc between the left and right lateral limits of the impact area with a radius of 800 m and centered at the launch position.

c. Surface Danger Zone adjustments.

(1) For ground-launched mode, if any point on the edge of the impact area is lower than the elevation of the launch position by more than 30 m, extend the impact area at that point by 1 m for every meter of drop in elevation greater than 30 m. For example, if a point of the SDZ at the edge of the impact area is 65 m below the launch position, extend

only that portion of the impact area 35 m (65 m-30 m=35 m) parallel with the edge of the impact area. For an illustration, see figure 7-3.

(2) When engaging moving or multiple targets, bisect figure 7-1 longitudinally and expand the MTL to accommodate the target array. This will establish the left and right limits of fire.

Table 7-1
TOW missile system configuration and range distances

DODIC	Marine Corps/ Army inventory asset	Warhead flight motor safety device (if equi- pped) ^{1, 2, 3, 4}	Protected platform blanket or under armor	SDZ Dimensions (m)					Max Ord elevation (m) AGL
				Distance X	Distance D	Area A	Area B	Area H	
Basic TOW Practice (3,750 m)									
PB99	MC	MOIC	YES	5,000	3,800	100	100	N/A	1,832
Basic TOW HEAT (3,750 m)									
WF10	MC	IMOIC	Yes	5,000	3,800	750	750	N/A	1,832
TOW 2 Practice (3,750 m)									
PV02	A		NO	5,000	3,800	100	100	N/A	1,832
WH06	MC	IMOIC	NO	5,000	3,800	100	100	N/A	1,832
TOW 2A HEAT (3,750 m)									
PD62	A/MC		YES	5,000	3,800	750	750	3,200	1,832
PE96	A/MC		NO	5,000	3,800	750	750	3,200	1,832
WH03	MC	IMOIC	NO	5,000	3,800	750	750	N/A	1,832
PV47	A/MC		NO	5,000	3,800	750	750	3,200	1,832
PV83	A		NO	5,000	3,800	750	750	3,200	1,832
PU16	MC Air		NO	5,000	3,800	750	750	3,200	1,832
PU08	MC Air		NO	5,000	3,800	750	750	3,200	1,832
WH04	A	IMOIC	YES	5,000	3,800	750	750	N/A	1,832
TOW 2A Practice (3,750 m)									
WH05	MC	IMOIC	NO	5,000	3,800	100	100	N/A	1,832
PU09	MC Air		NO	5,000	3,800	100	100	N/A	1,832
PV84	A		NO	5,000	3,800	100	100	N/A	1,832
TOW BB (Bunker Buster) (3,750 m)									
WH82	A		YES	5,000	3,800	750	750	3,200	1,888
WH50	A/MC		NO	5,000	3,800	750	750	3,200	1,888
TOW 2B HEAT (3,750 m)									
PV18	A/MC		NO	4,400	3,400	600	600	1,600	1,773
PV82	A/MC		NO	4,400	3,400	600	600	1,600	1,773
WF37	A		NO	4,400	3,400	600	600	1,600	1,773
TOW 2B AERO HEAT (4,500 m)									
WF93, WF94, WF95	A		NO	5,100	3,950	600	600	1,600	1,773

**Table 7-1
TOW missile system configuration and range distances—Continued**

DODIC	Marine Corps/ Army inventory asset	Warhead flight motor safety device (if equi- pped) ^{1, 2, 3, 4}	Protected platform blanket or under armor	SDZ Dimensions (m)					Max Ord elevation (m) AGL
WG02	A/MC		NO	5,100	3,950	600	600	1,600	1,773

Legend for Table 7-1:

A=Army

DODIC=Department of Defense Identification code

MC=Marine Corps

MOIC=Missile Ordnance Inhibit Circuit

IMOIC=Improved Missile Ordnance Inhibit Circuit

N/A=not applicable

Notes:

¹ The MOIC is installed in missiles which are retrofitted for use in training or demonstration. The retrofitted missiles can have either inert warheads or HEAT warheads. The MOIC improves firing-range safety.

² The MOICE further improves firing-range safety by disabling arming of the warhead until the missile is accelerated by the flight motor. A second rare failure mode occurs when a missile containing a MOIC has a flight motor failure and the missile falls to earth and rolls end-over-end causing the warhead to detonate after ground impact of the aft end of the missile.

³ IMOIC, MOIC, and MOICE are designed to be used in the basic and ITOW missiles (which have the 5 in warhead) and will not fit in the TOW 2 series (with the 5.8 in warhead). The components in the MOIC and the MOICE are repackaged in one unit called the IMOIC, which fits the TOW 2 and TOW 2A missiles and provides the same function as the combination of MOIC and MOICE.

⁴ DMOIC can be installed in analog missiles only and not in digital missiles. The DMOIC for digital missiles has been developed and will be installed in the digital electronics unit test cavity at the rear of the missile. The electrical interface will be via the digital electronics unit test connector and the over-rocked harness connector.

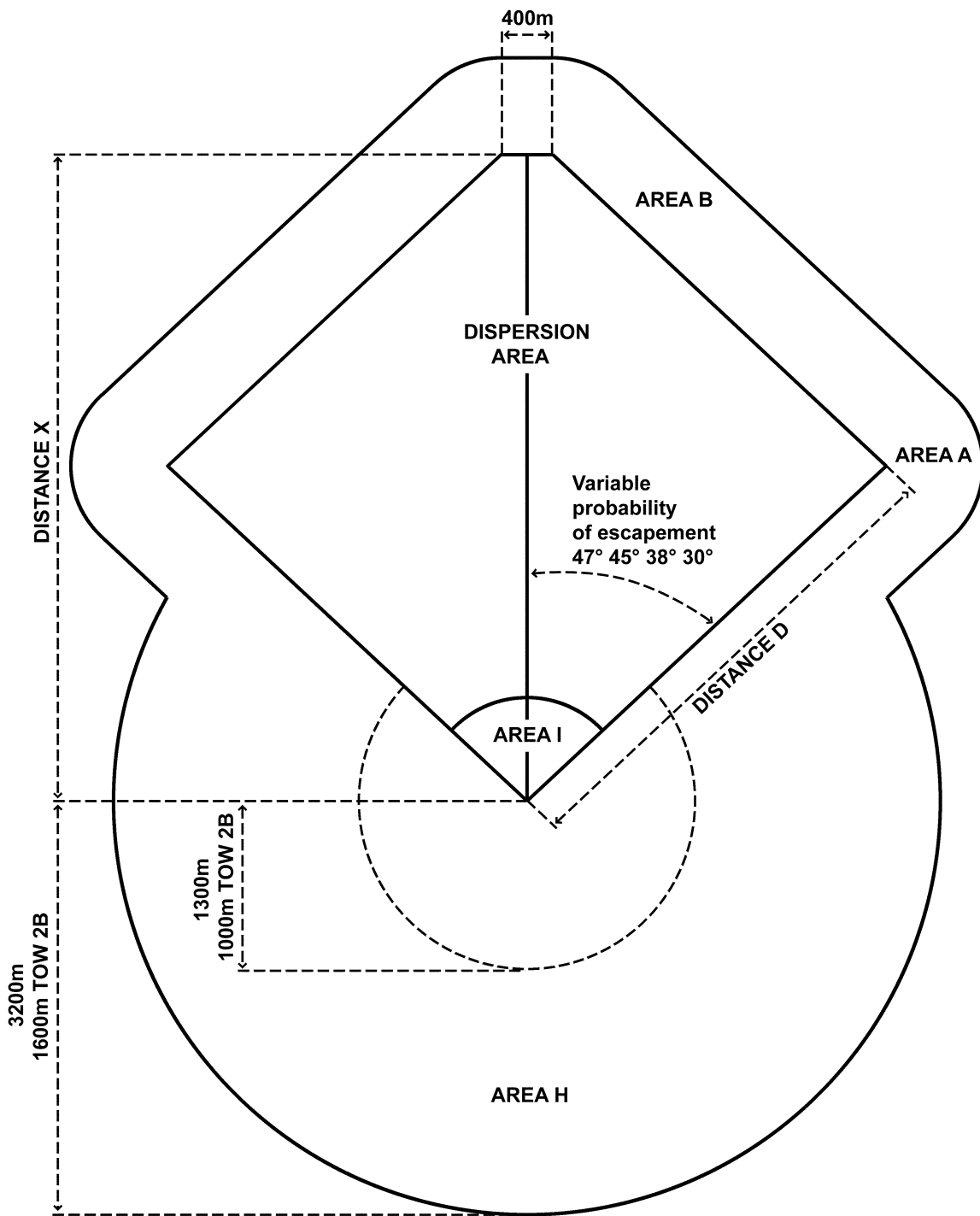

Figure 7-1. Surface danger zone for firing basic TOW, practice TOW, ITOW, TOW 2A, TOW 2B, TOW 2B AERO, and TOW BB missiles

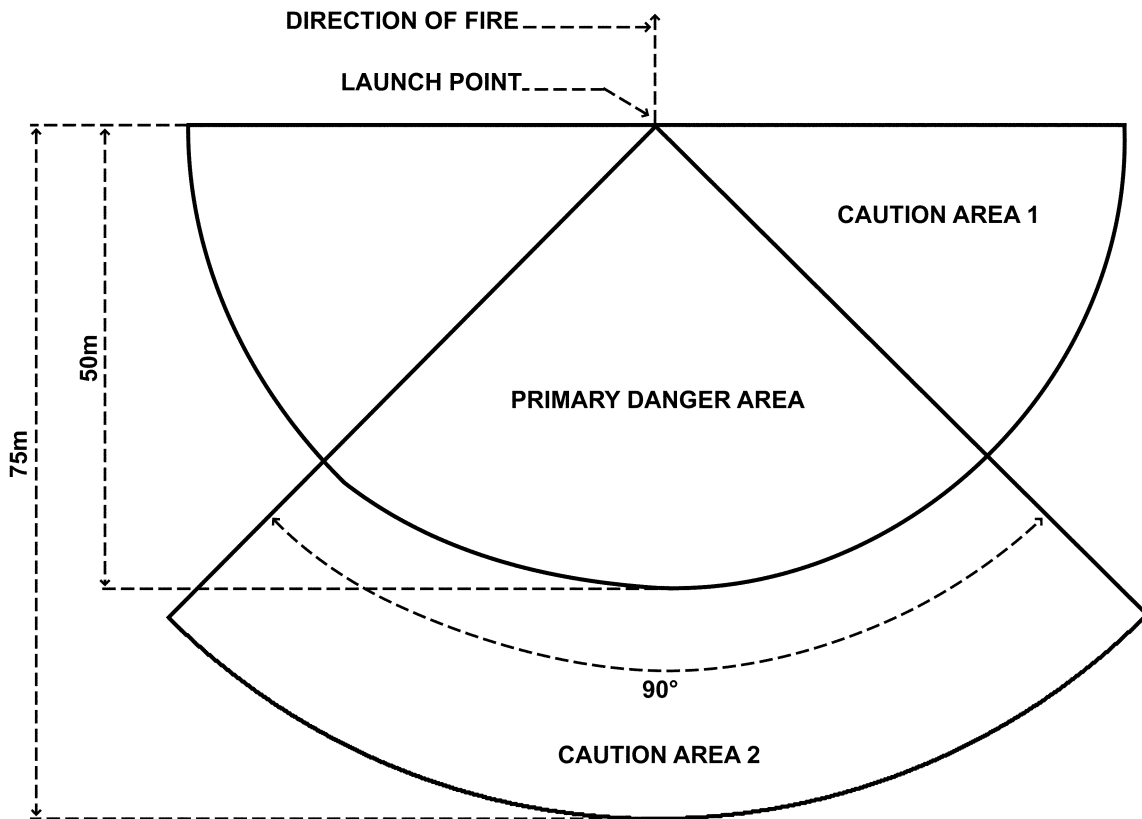

Figure 7-2. Surface danger zone, Area F, for firing basic TOW, practice TOW, ITOW, TOW 2A, TOW 2B, TOW 2B AERO, and TOW BB missiles

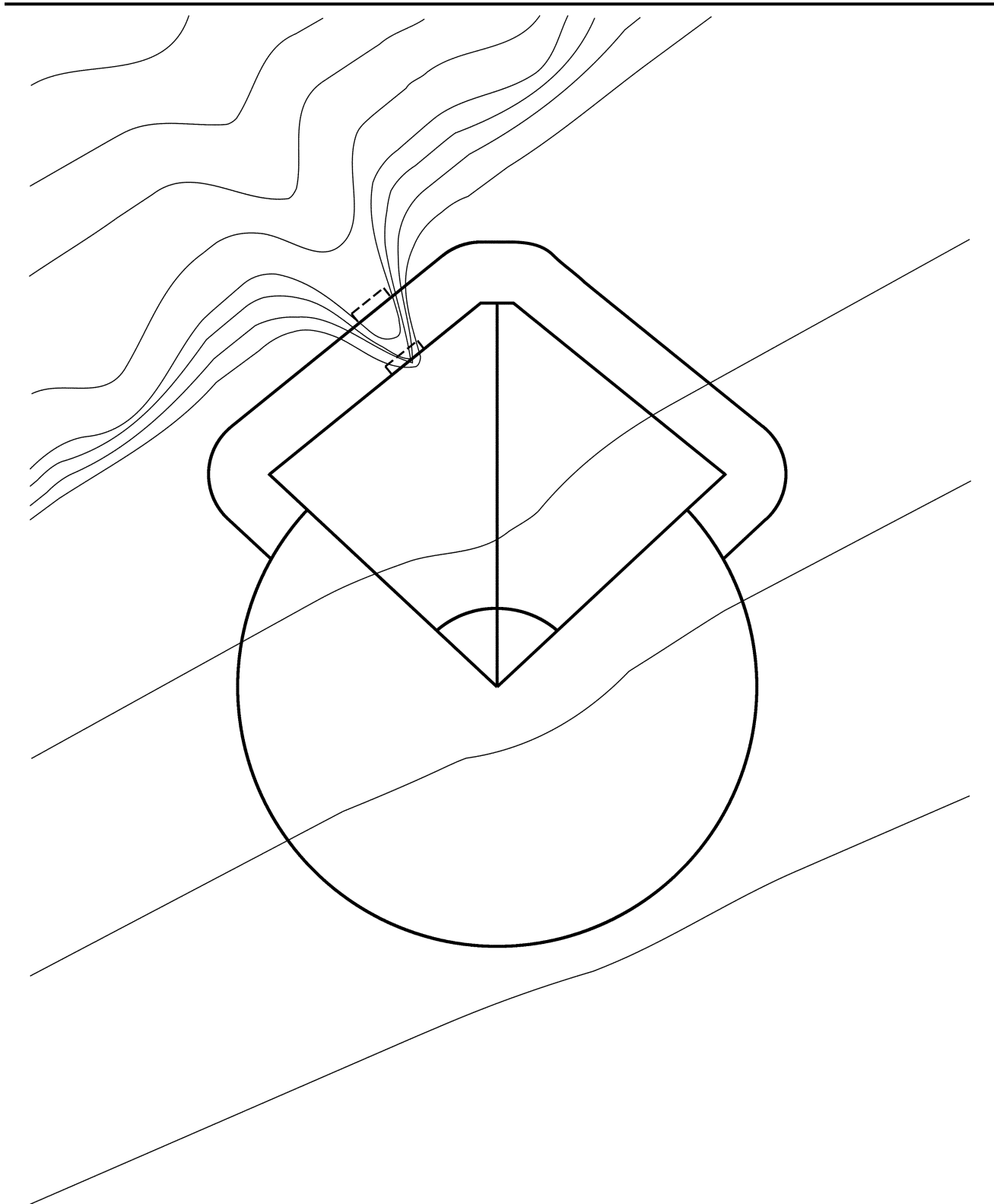

Figure 7-3. Surface danger zone adjustments for firing basic TOW, practice TOW, ITOW, TOW 2A, TOW 2B, TOW 2B AERO, and TOW BB missiles in a ground launch mode

d. Multiple integrated laser engagement system training. The TOW missile uses the anti-tank weapons effect signature simulator (ATWESS) device for a noise simulator. Use the SDZ in figure 7-4 to determine safe limits of use. ATWESS devices must never be armed until ready to fire. A severe jolt to the ATWESS may cause the device to function. Approved single hearing protection is required.

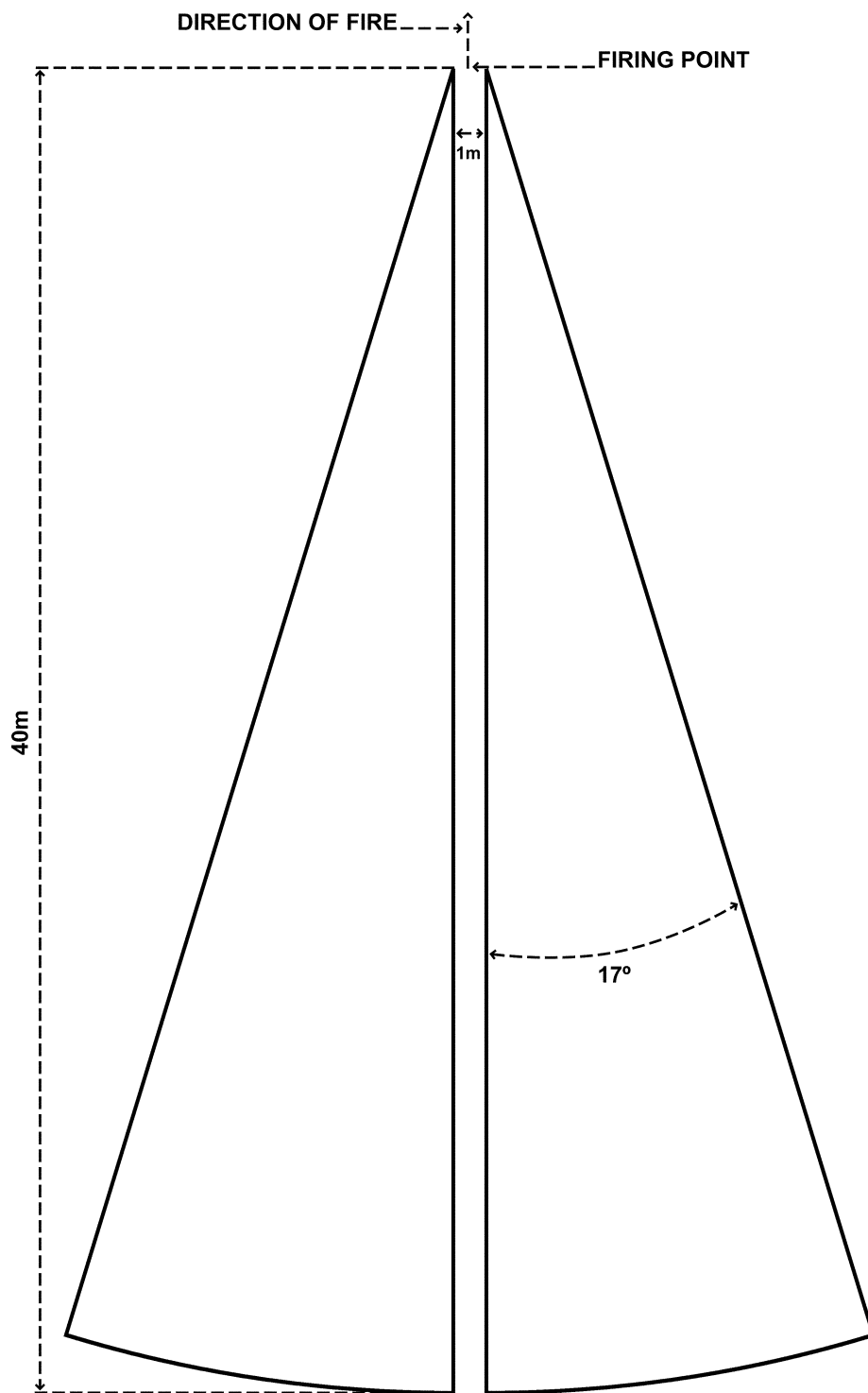

Figure 7-4. Area F for ATWESS and TOW missiles (Multiple Integrated Laser Engagement System training)

7-2. FGM-148 Javelin guided missile

The Javelin is a shoulder-launched, man-portable, anti-armor weapon system. It fires a passive-imaging infrared (IR) missile with a lock-on before launch guidance system. The Javelin Block 1 antitank missile has extended range capability, enhanced software, and an improved warhead.

a. Firing conditions.

(1) Before firing any Javelin missile, the entire SDZ will be cleared of non-participating personnel. Only those participating personnel specified in appropriate FMs and TMs will be permitted in any part of the SDZ.

(2) Javelin missile firings will be accomplished within predetermined boundaries. Installation RMAs (Army), RCOs (Marine Corps) will ensure that an adequate SDZ exists along the MTL from each anticipated launch position within the predetermined boundaries.

(3) See applicable FMs and TMs for preparation and firing operations.

(4) Personnel will neither stand nor permit any part of their body to be directly behind or in front of the Javelin launcher.

(5) Personnel engaged in firing or supervising Javelin missile training will wear a minimum of PPE Level 1. Refer to table 2-2 (Marine Corps) for further guidance.

(6) Personnel within 500 m of the target should be in a location protected from debris coming from the target.

b. Surface danger zone construction for the Javelin antitank missile.

(1) The SDZ for firing Javelin missile at a fixed target is illustrated in figure 7-5. This figure represents probability of missile fly-out, debris, fragmentation, and so forth, escaping the SDZ boundaries; 1 in 1,000,000 (10^{-6}) (21 degrees), 100,000 (10^{-5}) (17 degrees), and 10,000 (10^{-4}) (13 degrees). The dimensions found in figure 7-5 using 21 degrees is the standard Javelin missile SDZ. Javelin missile SDZ criteria are in table 7-2.

(2) The SDZ for Javelin Block 1 missile is in figure 7-6. Javelin Block 1 missile SDZ criteria are in table 7-3. Javelin Block 1 SDZ variable criteria are in table 7-4.

(3) Area A is 500 m wide for the HE warhead equipped rounds and 200 m for inert warhead rounds from the launcher to a point 1,000 m downrange for Javelin missiles and 1,327 m for Javelin Block 1 missiles. At these distances, the flight motor is fully exhausted. The remaining downrange portion of Area A tapers down to a 200 m width for HE warhead rounds and 100 m for inert warhead rounds at Distance X. Area A will contain missile and warhead debris from impacts on the boundary selected fly out line/trajectory limit and portions of the missile that remain attached to the propulsion section which may continue to be propelled until flight motor burnout.

(4) Area B will contain the debris associated with a missile landing at the uprange edge of the area. Area B is 500 m for both HE and inert warheads.

(5) Area F (see fig 7-7) consists of the primary danger area and caution areas 1, 2, and 3.

(a) The primary danger area is a 60 degree angle (30 degree either side of the rearward extension of the MTL) with the apex at the aft end of the missile launch motor. This area has a 25 m radius. Additionally, the primary danger area is extended forward to the firing line from a distance of 1 to 5 m left and right of the MTL (see fig 7-8).

(b) Caution Area 1 is an extension of the 25 m primary danger area arc forward to the firing line on each side of the launcher. Serious hearing impairment or damage from frequent exposure could occur to personnel in this area during firings. Personnel in this area must wear approved hearing protection devices.

(c) Caution Area 2 is an extension to the rear of the primary danger area, 10 m beyond the primary danger area.

(d) Caution Area 3 is an extension to the rear of the primary danger area within the 60 degree sector with a 100 m radius. This area is affected by the activation of the flight motor pressure relief system. Personnel located in this area will wear eye protection.

(6) The use of an SDZ with a missile fly out probability of greater than 10^{-6} (such as, 10^{-5} , or 10^{-4}) requires an approved deviation in accordance with AR 385-63/MCO 3570.1C and chapter 1 of this pamphlet.

Table 7-2
Javelin missile surface danger zone criteria, in meters

Javelin Missile	Distance X	Area A	Area B	Minimum range to target	Vertical hazard	Area F		
						Primary danger area/ Caution Area 1	Caution Area 2	Caution Area 3
HEAT	4,000	500 to 200	500	500	660	25	35	100
Inert	4,000	200	500	500	660	25	35	100

Legend for Table 7-2:
HEAT=high explosive anti-tank

Table 7-3
Javelin Block 1 missile surface danger zone criteria, in meters

Javelin Block 1 Missile	Distance X	Area A	Area B	Minimum range to target	Vertical hazard	Area F		
						Primary danger area/ Caution Area 1	Caution Area 2	Caution Area 3
HEAT	6,000	500 to 200	500	500	660	25	35	100
Inert	6,000	200	500	500	660	25	35	100

Legend for Table 7-3:
 HEAT=high explosive anti-tank

Table 7-4
Javelin Block 1 surface danger zone variable criteria

Missile fly out probability	Variable probability of escapement angle	Cross range
10 ⁻⁶	37 degrees	1,000 m
10 ⁻⁵	20 degrees	740 m
10 ⁻⁴	13 degrees	330 m

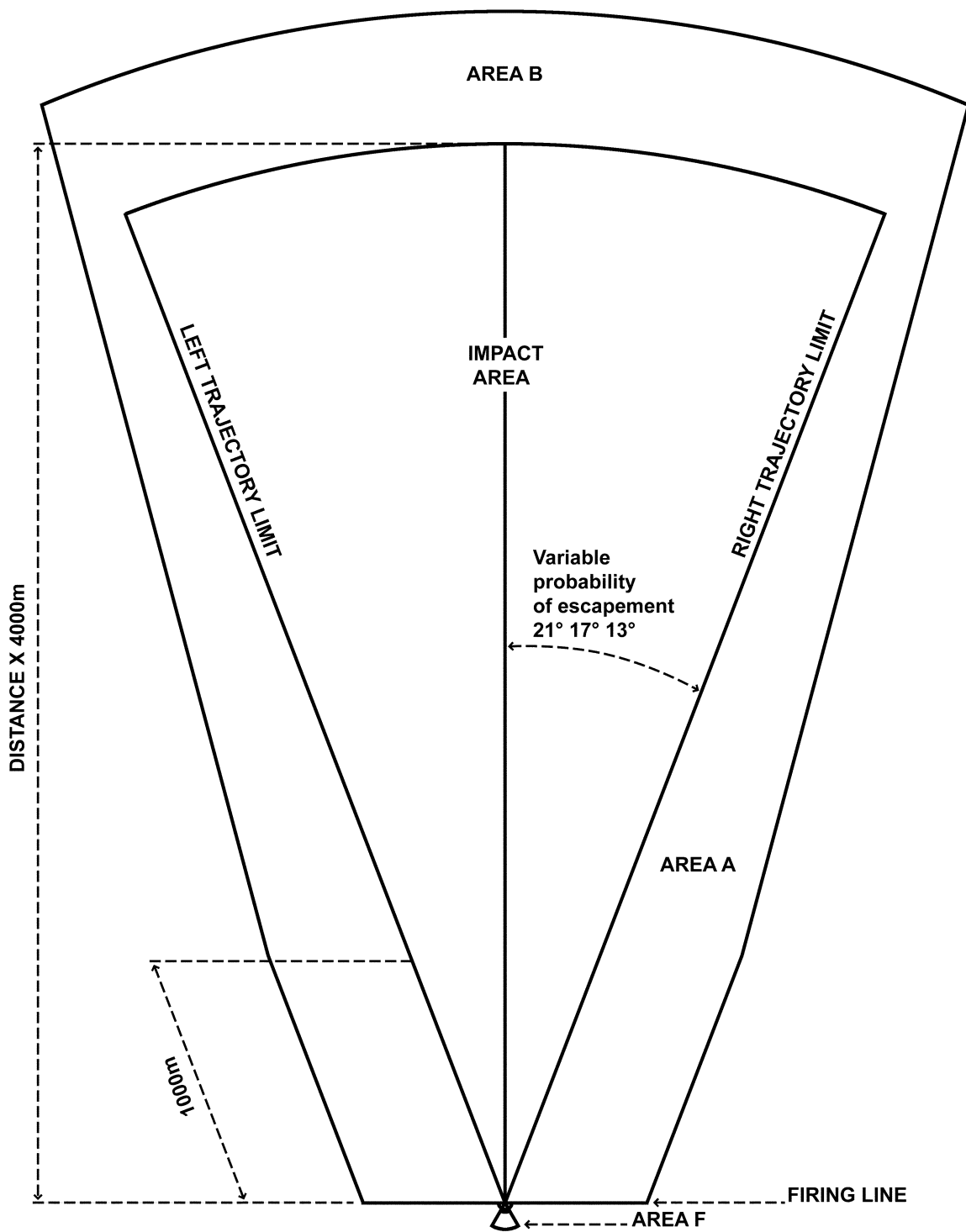

Figure 7-5. Surface danger zone for Javelin missiles

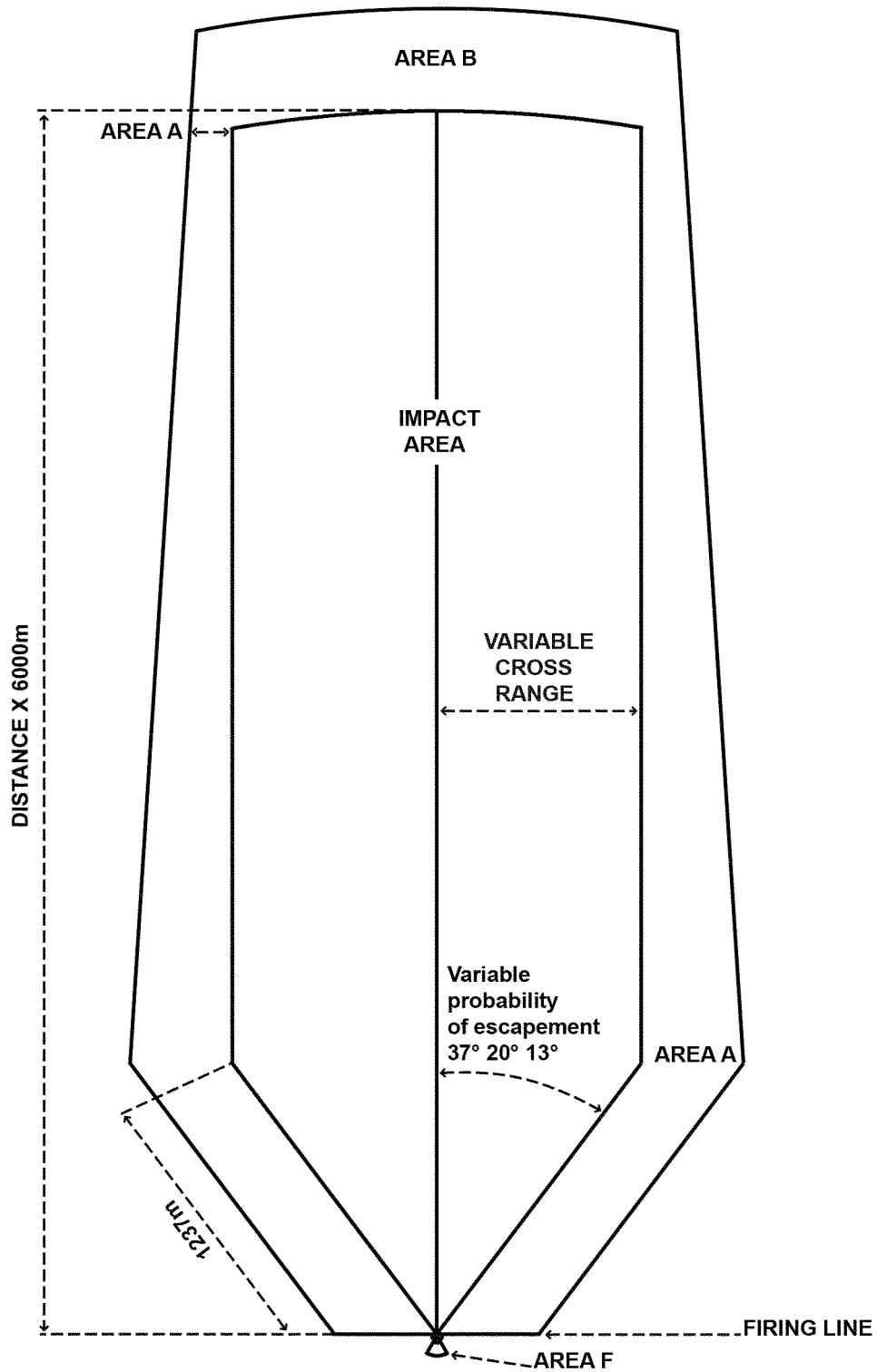

Figure 7-6. Surface danger zone for Javelin Block 1 missiles

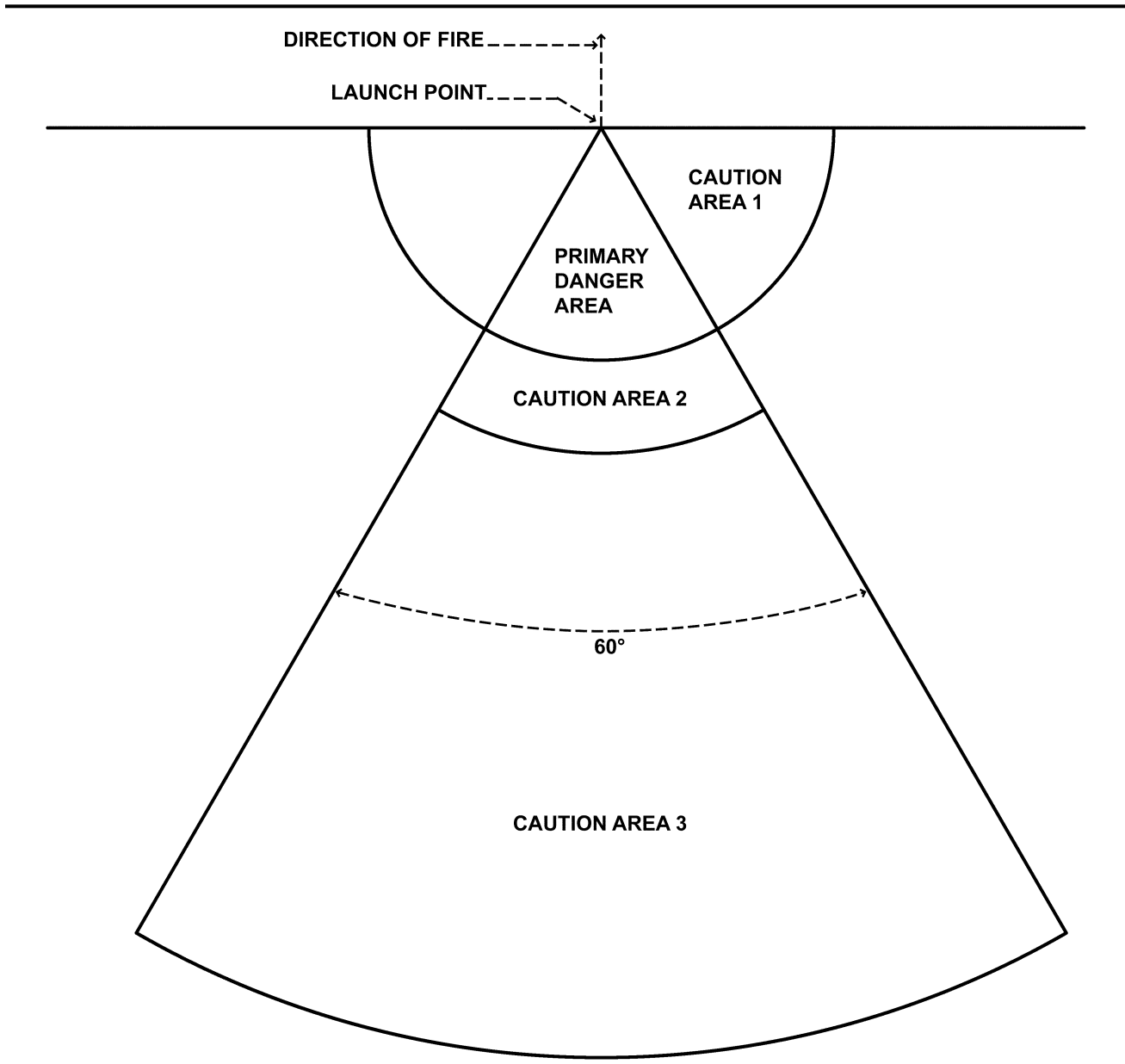

Figure 7-7. Surface danger zone Area F, for Javelin missiles

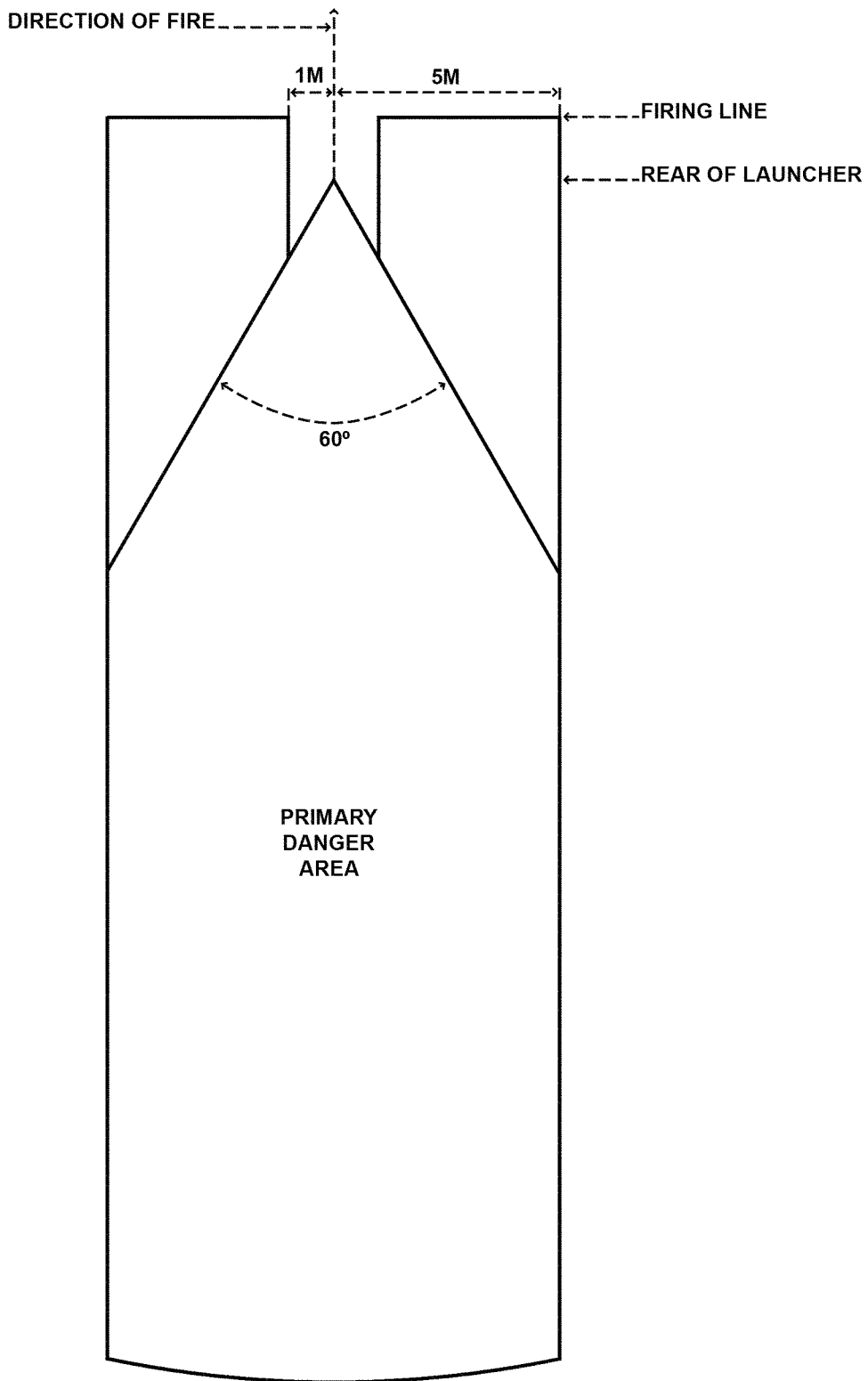

Figure 7-8. Primary danger area, Area F, extension for activation of the Javelin missile flight motor pressure relief system

Chapter 8 Tank/Fighting Vehicle Gunnery

8-1. Tank/fighting vehicle firing conditions

a. Tank/fighting vehicle weapon system will not be fired above 5 degrees (89 mils) quadrant elevation (QE) from the firing position to the target (unless otherwise stated in this pamphlet). The following procedures will be employed.

(1) Unit master gunners, in conjunction with range operations (Army), range control (Marine Corps) personnel, will ensure that targets are placed at or less than 5 degrees elevation. Tank commanders will ensure that all weapon systems in a firing condition are pointed toward the impact area at or less than 5 degrees elevation.

(2) Non-stabilized tank armament will not be fired while the tank/fighting vehicle is moving. This does not include machine guns.

b. When firing ranges and weapons training facilities with less than the prescribed safety limits must be used, existing compensatory terrain features and offsetting control measures will be thoroughly evaluated. An approved deviation is required before firing on reduced SDZs.

c. Hard or soft targetry may be used.

d. Cross-range firing of weapon systems from firing positions at targets or target arrays on the opposite side of the range is permitted if the SDZ falls within allowable limits, and the risk of damage to target systems has been accepted by the RMA (Army), RCO (Marine Corps). Limits of fire, combined dispersion, ricochet areas, and Areas A and B (when required), must be adjusted to compensate for and accommodate such cross-range firing. On ranges that do not permit cross-range firing, internal (inside the range area) left and right limit of fire markers, with both visual and thermal signature, will be used in addition to the left and right external range limit markers.

e. Environmental containment materials (spill kits) shall be available on all mounted ranges, during all refuel operations, and whenever the vehicles involved in the training event are on the range.

8-2. Surface danger zone

Tank/fighting vehicle SDZs for direct fire at fixed or moving ground targets from stationary or moving firing positions are as follows:

a. General tank cannon cartridges (for example, those cartridges not specifically addressed in this pamphlet) use table 8-1 and figure 8-1. Lateral dimensions must take into account length of baselines, maneuver areas, and target arrays to include length of moving targets. Distance X for non-stabilized weapons will be equivalent to QE of 10 degrees.

b. The dispersion area for tank/fighting vehicle SDZs is 2 degrees with a stabilized weapon system. The dispersion area for tank/fighting vehicle SDZs utilizing non-stabilized weapon systems is 5 degrees.

c. Areas A and B are not required when firing inert/non HE projectiles at soft targets, except spotting charges or frangible projectiles which may eject a hazardous fragment.

d. When engaging armor targets, use the impact media that has the greater value due to the possibility of missing the target.

e. For fighting vehicles the Distance X (maximum range) may be reduced to ricochet range when engaging ground targets at ranges up to 3,500 m from stationary firing positions.

f. For fighting vehicles, when firing from a moving vehicle over level terrain at ground targets up to 3,500 m, use the 15 degrees elevation range, when firing on the move over rough terrain, use Distance X.

g. For fighting vehicles, when firing at aerial targets and the gun elevation is greater than 15 degrees, the ricochet area, as defined by Area W and Angle P, is not required.

h. SDZ requirements for firing port weapon systems are provided in chapter 4 (small arms criteria) and figure 8-6. Firing port weapon systems may be fired selectively or as part of a course provided:

(1) Sufficient terrain is available to accommodate the weapon system's SDZ fired at its extreme elevation and limits of traverse.

(2) An established impact area exists with targets or target arrays.

Table 8-1
General tank cannon cartridge surface danger zone criteria

Ammunition caliber	Impact media	Area A (m)	Area B (m)	Distance direct fire¹ (m)	Vertical hazard² (m)
105mm gun	N/A	615	615	650	See note 2
120mm	N/A	750	750	1,000	See note 2

Legend for Table 8-1:

N/A=not applicable

Notes:

¹ Direct fire distances are minimum distances required for safety of unprotected personnel from hazardous fragments resulting firing HE projectiles. Vehicle must be buttoned up and all unprotected personnel must be provided positive protection against fragments.

² For vertical hazard distance refer to table 8-2.

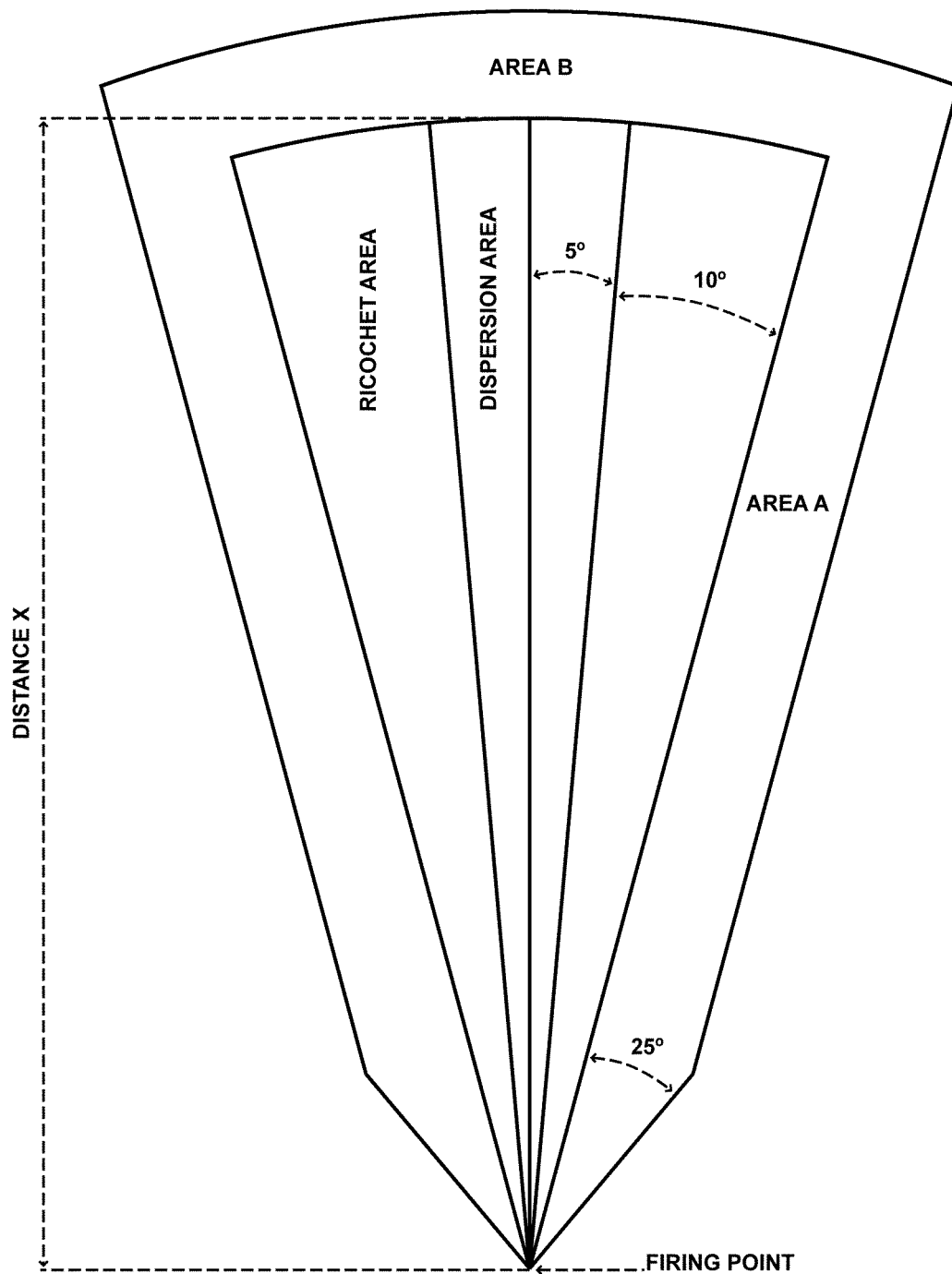

Figure 8-1. Surface danger zone for firing general tank cannon cartridges

i. The SDZ data for M1040 105mm and M1028 120mm anti-personnel (APERS) canisters covered in table 8–2 and figure 8–2. SDZ data for M494 105mm APERS–T is covered in table 8–2 and figure 8–2. The flechette dispersion pattern for the M494 is covered in figure 8–4.

j. For select tank cannon cartridges use tables 8–2 and 8–3 and figure 8–2.

Table 8–2
Select tank cannon cartridge surface danger zone criteria

Ammunition	Impact media	Distance X (m)	Angle P (deg)	Distance W (m)	Area A (m)	Area B (m)	Vertical hazard ² (m)
105mm							
M393A1 TP–T	Earth	5,474	24	1,225	NR	NR	1,090
	Steel	5,474	24	1,125	NR	NR	1,090
M393A1/2 HEP–T	Earth	5,474	24	1,225	615	615	1,090
	Steel	5,474	24	1,125	615	615	1,090
M393A3 HEP–T	Earth	8,175	24	1,225	300	300	962
	Steel	7,600	20	1,125	300	300	1,090
M456 HEAT–T	Earth	6,436	17	1,080	615	615	See note 2
	Steel	6,436	12	600	615	615	
M467A1 TP–T	Earth	8,175	24	1,225	NR	NR	962
	Steel	7,600	20	1,125	NR	NR	1,090
M490 TP–T	Earth	6,445	17	1,080	NR	NR	See note 2
	Steel	6,445	12	600	NR	NR	
M494 APERS–T	Earth	4,400	40	550	NR	NR	415
	Steel	4,400	50	850	NR	NR	820
M724 TPDS–T	Earth	11,343	13	1,110	NR	NR	See note 2
	Steel	11,343	11	1,900	NR	NR	
M735 APFSDS–T	Earth	22,846	14	1,100	NR	NR	See note 2
	Steel	22,846	16	1,400	NR	NR	
M774 APFSDS–T ¹	Earth	23,545	12	1,020	NR	NR	See note 2
	Steel	23,545	16	1,400	NR	NR	
M833 APFSDS–T ¹	Earth	26,241	16	1,801	NR	NR	See note 2
	Steel	26,241	16	1,400	NR	NR	
M1040 Canister	Earth	1,300	40	550	NR	NR	415
	Steel	1,300	50	850	NR	NR	820
120 mm							
M829A2 APFSDS–T ¹	Earth	30,261	26	2,400	NR	NR	See note 2
	Steel	30,261	21	1,764	NR	NR	
M829A3 APFSDS–T ¹	Earth	30,418	26	2,400	NR	NR	See note 2
	Steel	30,418	21	1,764	NR	NR	
M830 HEAT–MP–T	Earth	6,589	17	1,080	1,125	1,125	See note 2
	Steel	6,589	12	600	1,125	1,125	
M830A1 HEAT–MP–T ¹	Earth	10,069	22	1,239	1,377	1,377	See note 2
	Steel	10,069	20	1,061	1,377	1,377	
M831 TP–T	Earth	6,589	17	1,080	NR	NR	See note 2
	Steel	6,589	12	600	NR	NR	
M865 TPCSDS–T	Earth	7,234	12	450	NR	NR	See note 2
	Steel	7,234	16	1,400	NR	NR	
M908 HE–OR–T	Earth	10,069	22	1,239	1,377	1,377	See note 2
	Steel	10,069	20	1,061	1,377	1,377	

Table 8-2
Select tank cannon cartridge surface danger zone criteria—Continued

Ammunition	Impact media	Distance X (m)	Angle P (deg)	Distance W (m)	Area A (m)	Area B (m)	Vertical hazard ² (m)
M1028 Canister	Earth	1,650	30	550	NR	NR	550
	Steel	1,650	55	850	NR	NR	1,050

Legend for Table 8-2:

APFSDS-T=armor piercing, fin-stabilized discarding sabot-tracer
 HE=high explosive
 HEAT=high-explosive anti-tank
 HEP=high-explosive plastic
 MP=multipurpose
 NR=not required
 OR=obstacle reduction
 TP-T=target practice-tracer
 TPDS-T=target practice discarding sabot-tracer
 TPCSDS-T=target practice, cone-stabilized discarding sabot-tracer

Notes:

¹ Ammunition is a wartime round. SDZ is advisory only. M774, M833, M829A2, and M829A3 projectiles contain depleted uranium (DU) penetrator.

² Use the sum of the values of Distance W and Area A (if applicable) until validated test data is available.

Table 8-3
Surface danger zone parameters for 120mm Target Practice Multi Purpose -Tracer Cartridge M1002¹

Altitude (ft)	Impact Media	Distance X (m)	Angle P ² (deg)	Distance W (m)	Area A (m)	Area B (m)	Vertical hazard (m)
0	Earth	7,200	30	975	NR	NR	1,252
	Steel	7,200	22	550	NR	NR	816
1,000	Earth	7,425	30	1,010	NR	NR	1,288
	Steel	7,425	22	575	NR	NR	842
2,000	Earth	7,650	30	1,045	NR	NR	1,325
	Steel	7,650	22	600	NR	NR	868
3,000	Earth	7,875	30	1,080	NR	NR	1,363
	Steel	7,875	22	625	NR	NR	869
4,000	Earth	8,100	30	1,115	NR	NR	1,402
	Steel	8,100	22	650	NR	NR	924
5,000	Earth	8,325	30	1,150	NR	NR	1,444
	Steel	8,325	22	675	NR	NR	954
6,000	Earth	8,550	30	1,185	NR	NR	1,486
	Steel	8,550	22	700	NR	NR	985
7,000	Earth	8,775	30	1,220	NR	NR	1,530
	Steel	8,775	22	725	NR	NR	1,017

Legend for Table 8-3:

NR=not required

Notes:

¹ Elevation of fire from firing position to target will not exceed 5 degrees.

² To correct for cross wind, dispersion angle is increased by 0.15 degree per m/s or 0.075 degree per knot.

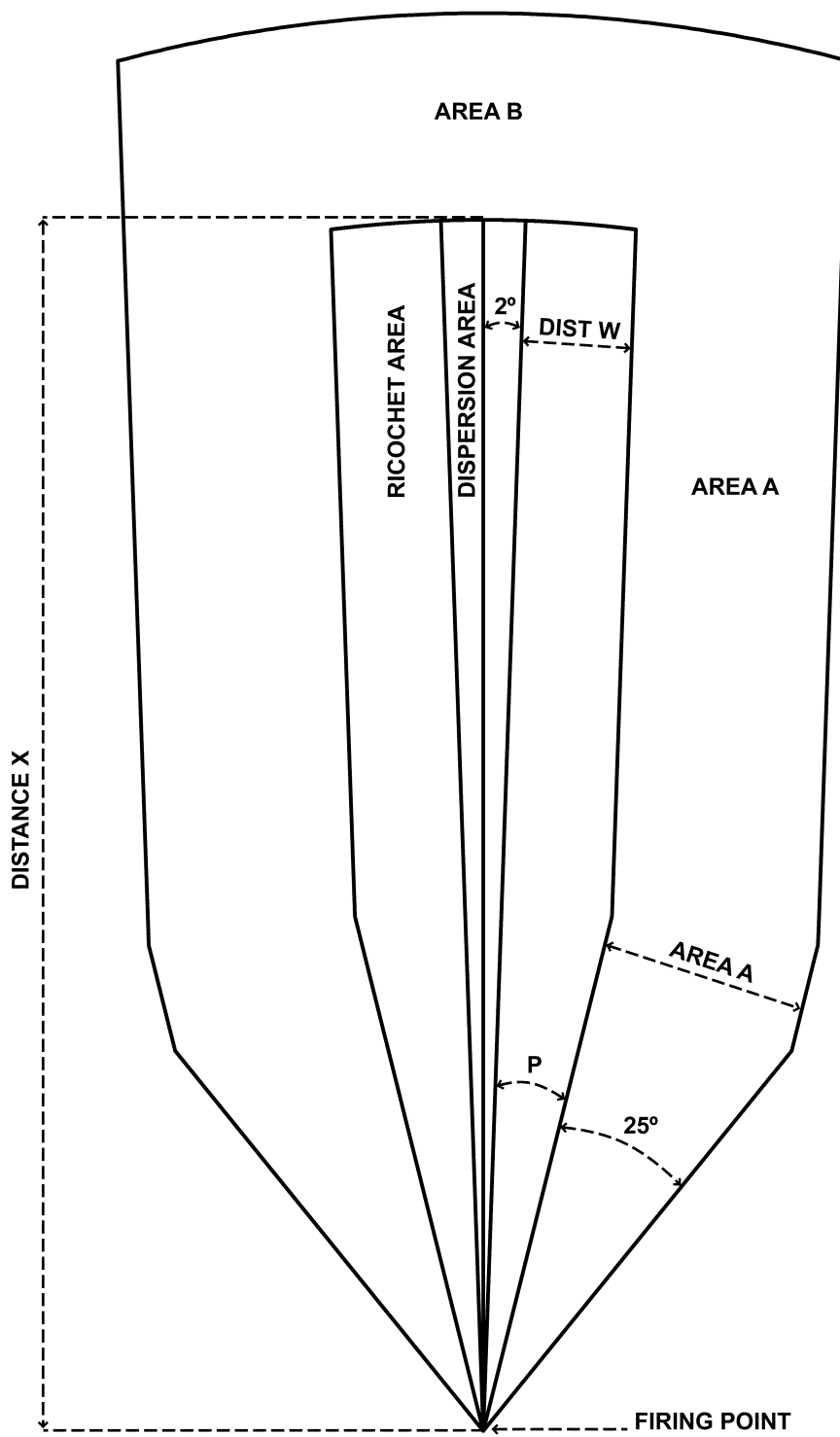

Figure 8-2. Surface danger zone for firing select tank cannon cartridges

k. For cartridges M865 and M1002 sabot discard hazard, use table 8-4 and figure 8-3.

Table 8-4
Surface danger zone criteria for M865 and M1002 sabot petal discard hazard

Ammunition	Distance X (m)	Distance Y (m)	Distance W (m)	Area R ¹ width (m)	Area R ² depth (m)
M865 TPCSDS-T	1300	200	300	140	0
M1002 MPAT-TP-T	750	75	250	140	0

Notes:

¹ SDZ holds for constant winds up to 12.5 m/s or 25 knots.

² Area R Depth is not needed for the M865 and M1002.

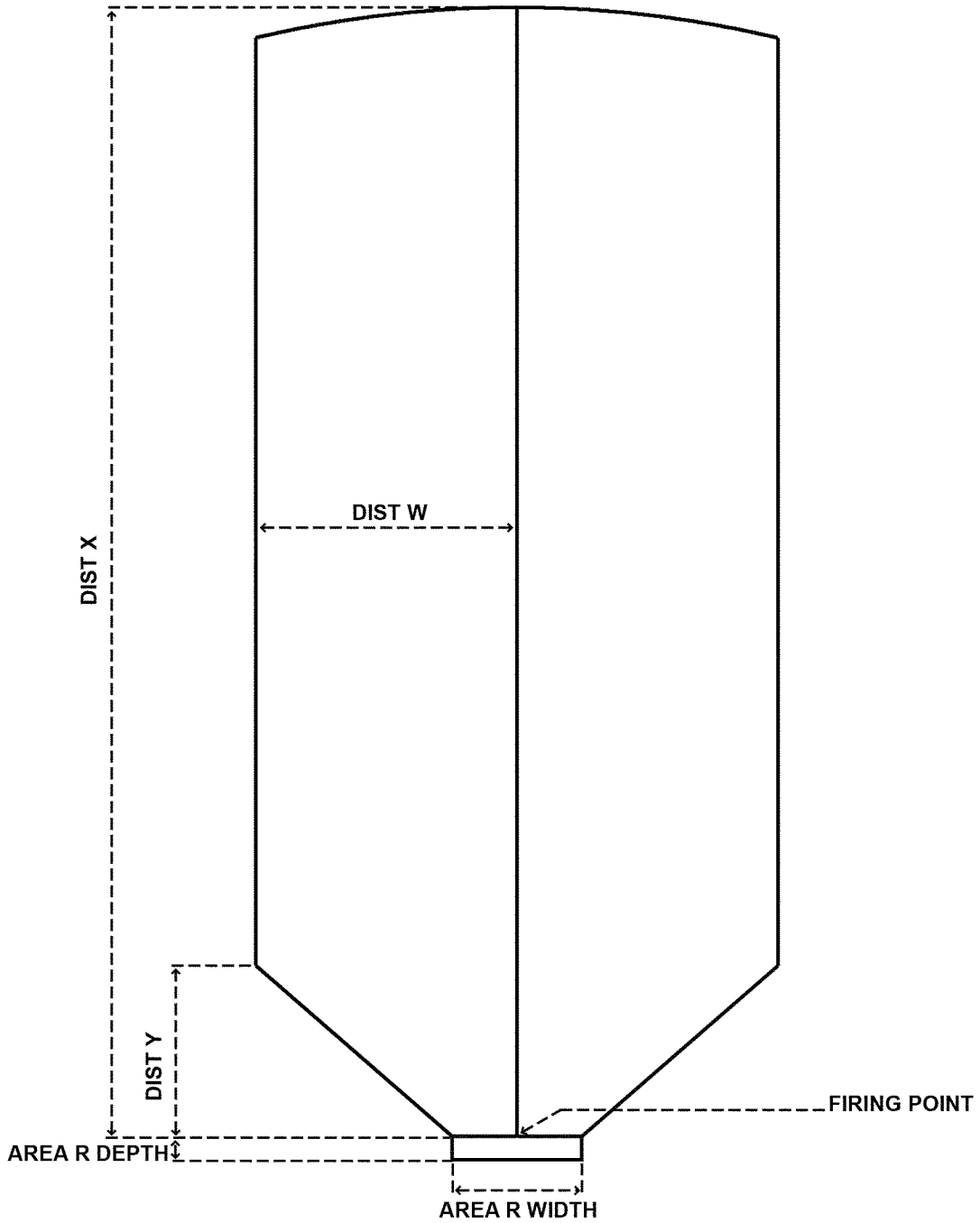

Figure 8-3. Surface danger zone for M865 and M1002 sabot petal discard hazard

1. For cartridge M968, 35mm tank/fighting vehicle precision gunnery inbore device, use table 8-5 and figure 8-2.

Table 8-5
Surface danger zone criteria for firing M968, 35mm tank precision gunnery inbore device cartridge corresponding to target ranges

Target range (m)	Impact media	Distance X (m)	Angle P (deg)	Distance W (m)	Area A (m)	Area B (m)	Vertical hazard (m)
100	Earth	5,799	27	1,786	NR	NR	642
	Water	5,722	30	1,559	NR	NR	642
	Concrete	6,051	37	2,023	NR	NR	974
	Steel	5,750	42	2,301	NR	NR	1,133
500	Earth	5,902	24	1,844	NR	NR	622
	Water	5,944	22	1,528	NR	NR	605
	Concrete	6,261	30	2,068	NR	NR	916
	Steel	6,991	35	2,078	NR	NR	1,068
1,000	Earth	6,150	20	1,752	NR	NR	565
	Water	6,195	20	1,495	NR	NR	557
	Concrete	6,797	27	1,961	NR	NR	840
	Steel	6,230	29	2,191	NR	NR	980
1,500	Earth	6,752	17	1,225	NR	NR	505
	Water	6,771	17	1,487	NR	NR	504
	Concrete	6,476	26	1,180	NR	NR	760
	Steel	7,237	26	2,245	NR	NR	876
2,000	Earth	6,995	14	1,165	NR	NR	444
	Water	6,889	15	1,458	NR	NR	437
	Concrete	6,613	20	1,649	NR	NR	671
	Steel	6,776	23	2,067	NR	NR	775
2,500	Earth	7,005	13	1,211	NR	NR	354
	Water	6,934	13	1,393	NR	NR	362
	Concrete	7,144	17	1,548	NR	NR	546
	Steel	7,557	19	1,735	NR	NR	670
3,000	Earth	7,914	10	1,020	NR	NR	279
	Water	7,633	11	1,268	NR	NR	273
	Concrete	7,530	14	1,298	NR	NR	442
	Steel	7,453	17	1,732	NR	NR	527
3,500	Earth	7,713	10	980	NR	NR	193
	Water	8,114	9	847	NR	NR	188
	Concrete	7,816	11	1,190	NR	NR	318
	Steel	7,779	14	1,600	NR	NR	384
4,000	Earth	7,752	8	748	NR	NR	165
	Water	7,380	6	591	NR	NR	162
	Concrete	8,864	11	1,100	NR	NR	217
	Steel	8,190	10	1,101	NR	NR	272
4,500	Earth	7,365	6	658	NR	NR	132
	Water	7,360	5	495	NR	NR	130
	Concrete	8,327	8	883	NR	NR	160
	Steel	8,585	10	1,126	NR	NR	197
5,000	Earth	7,590	6	434	NR	NR	130
	Water	8,299	3	328	NR	NR	98
	Concrete	8,096	6	670	NR	NR	139
	Steel	9,076	8	995	NR	NR	150
5,500	Earth	7,745	3	307	NR	NR	188
	Water	7,047	2	166	NR	NR	51
	Concrete	8,238	6	751	NR	NR	188
	Steel	8,620	7	629	NR	NR	188
6,000	Earth	7,257	1	68	NR	NR	262
	Water	7,027	1	70	NR	NR	29
	Concrete	8,243	4	405	NR	NR	262
	Steel	8,556	5	622	NR	NR	262

Legend for Table 8-5:
 NR=not required

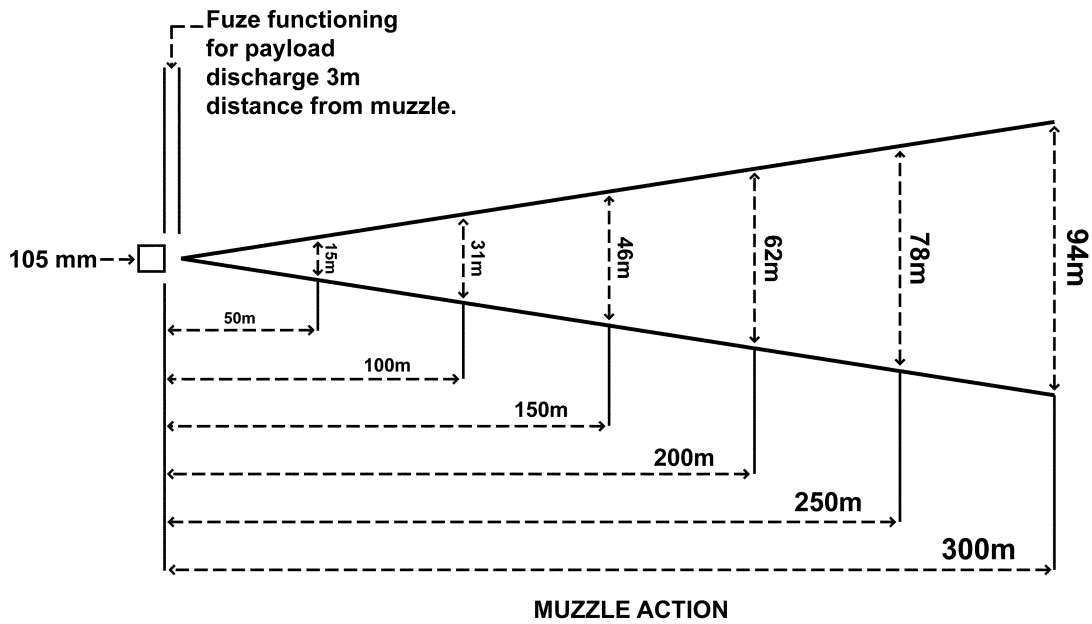
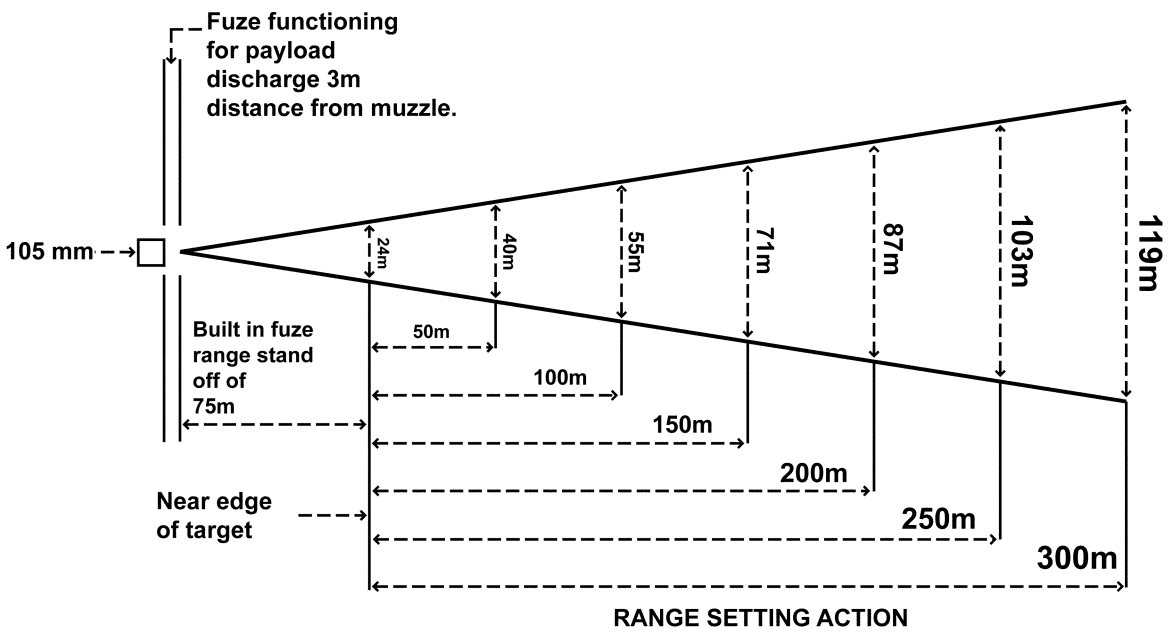

Figure 8-4. Flechette dispersion pattern for for M494 105mm, APERS-T

8-3. Fighting vehicles

a. Surface danger zone requirements for the M242 Bushmaster 25mm cannon are provided in table 8-6 and figure 8-5.

Table 8-6
25mm surface danger zone criteria

Ammunition	Impact media	Distance X (m)	Ricochet range (m)	Angle P (deg)	Distance W ² (m)	15 degrees elevation range (m)	Area A (m)	Area B (m)	Vertical hazard ² (m)
M791 APDS-T	Earth	14,572	7,402	18	1,466	11,561	NR	NR	See note 2
	Water	14,572	5,665	6	263	11,561	NR	NR	
	Concrete	14,572	7,622	34	2,208	11,561	NR	NR	
	Steel	14,572	7,294	24	1,510	11,561	NR	NR	
M792 HEI-T	Earth	6,379	4,792	19	908	5,249	300	400	See note 2
	Water	6,379	4,823	19	1,047	5,249	300	400	
	Concrete	6,379	5,071	27	1,290	5,249	300	400	
	Steel	6,379	5,265	28	1,373	5,249	300	400	
M793 TP-T	Earth	6,047	4,792	19	908	5,114	NR	NR	See note 2
	Water	6,047	4,823	19	1,047	5,114	NR	NR	
	Concrete	6,047	5,071	27	1,290	5,114	NR	NR	
	Steel	6,047	5,265	28	1,373	5,114	NR	NR	
M910 TPDS-T	Earth	6,404	4,592	15	734	5,868	NR	NR	See note 2
	Water	6,404	3,724	4	148	5,868	NR	NR	
	Concrete	6,404	4,643	27	1,143	5,868	NR	NR	
	Steel	6,404	4,472	20	799	5,868	NR	NR	
M919 APFSDS-T ¹	Earth	18,480	7,725	21	801	14,816	NR	NR	See note 2
	Water	18,480	7,725	21	801	14,816	NR	NR	
	Concrete	18,480	7,867	25	1,289	14,816	NR	NR	
	Steel	18,480	7,867	25	1,289	14,816	NR	NR	

Legend for Table 8-6:

APFSDS-T=armor piercing, fin-stabilized discarding sabot-tracer

NR=not required

HEI-T=high explosive incendiary-tracer

TP-T=target practice-tracer

TPDS-T=target practice, discarding sabot-tracer

Notes:

¹ Ammunition is a wartime round. SDZ is advisory only. M919 projectiles contain depleted uranium (DU) penetrator.

² Use the sum of values of Distance W and Area A (if applicable) until validated test data is available.

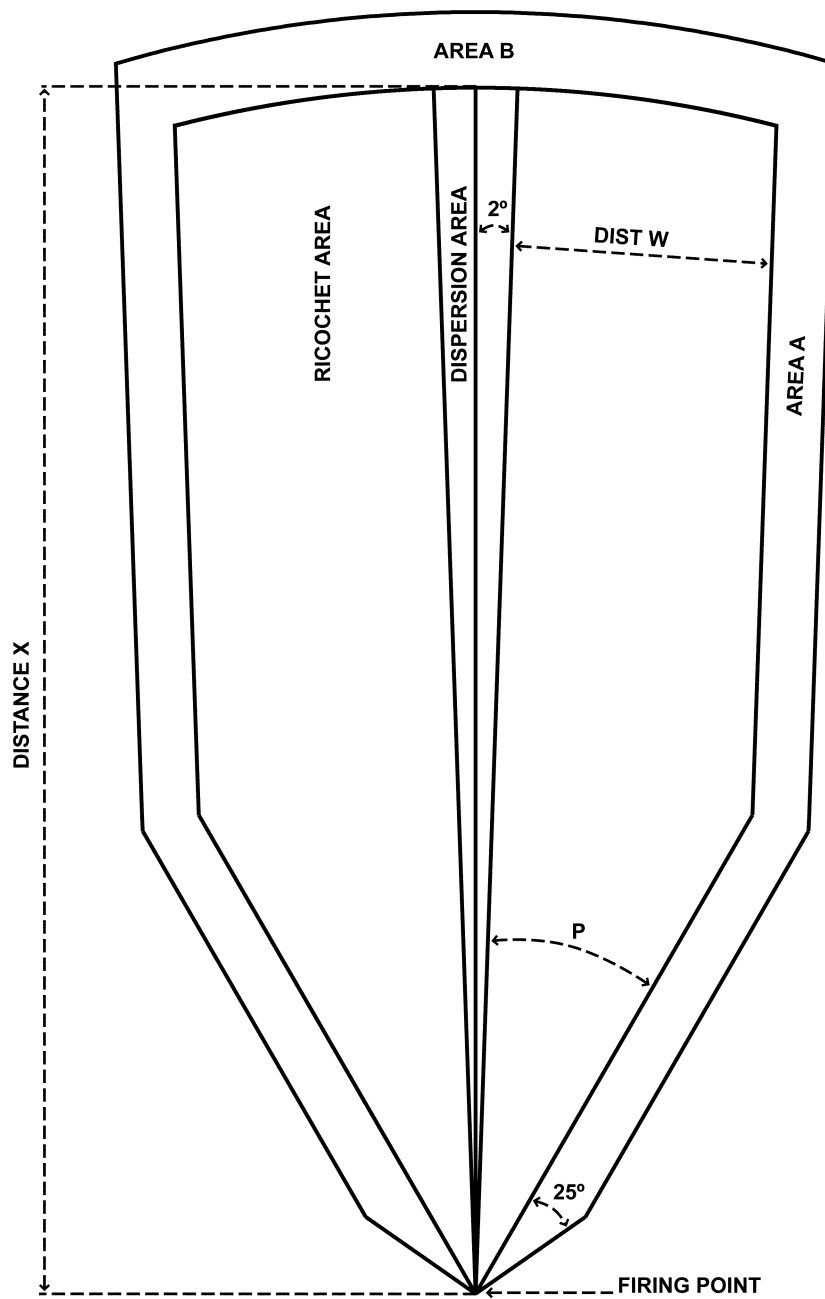

Figure 8-5. Surface danger zone for firing 25mm and 30mm cannon cartridges

b. b. For the Marine Corps' MK44 Bushmaster II 30mm weapon system, when conducting fighting vehicle training with elevation limitations, use the SDZ template found in figure 8-5 and the data found in tables 8-7 through 8-16. For free gun training, use the batwing SDZ template found in chapter 4, with the data found in tables 8-12 through 8-16. To correct for cross range wind, the dispersion angle of 2 degrees must be increased by 0.1 degree per m/s or 0.05 degree per knot of cross range wind.

(1) For free gun training, to correct for cross range wind the dispersion angle of 5 degrees must be increased by 0.25 degree per m/s or 0.13 degree per knot of cross range wind.

(2) For elevation restriction (5 degrees), to correct for cross range wind the dispersion angle is increased by 0.1 degree per m/s or 0.05 degree per knot of cross range wind.

Table 8-7
Surface danger zone parameters for 30mm MK239 TP-T (Fighting Vehicle - Elevation Restriction)

Altitude (ft)	Impact media	Distance X (m)	Ricochet Angle P (deg)	Distance W (m)	Area A (m)	Area B (m)	Vertical hazard (m)
0	Armor Plate	6,000	17	750	NR	NR	575
	Earth	6,000	8	575	NR	NR	570
1,000	Armor Plate	6,140	17	765	NR	NR	590
	Earth	6,140	8	590	NR	NR	585
2,000	Armor Plate	6,280	17	780	NR	NR	605
	Earth	6,280	8	605	NR	NR	600
3,000	Armor Plate	6,420	17	795	NR	NR	620
	Earth	6,420	8	620	NR	NR	615
4,000	Armor Plate	6,590	17	825	NR	NR	636
	Earth	6,590	8	640	NR	NR	631
5,000	Armor Plate	6,760	17	855	NR	NR	652
	Earth	6,760	8	660	NR	NR	647
6,000	Armor Plate	6,930	17	885	NR	NR	668
	Earth	6,930	8	680	NR	NR	663
7,000	Armor Plate	7,100	17	915	NR	NR	685
	Earth	7,100	8	700	NR	NR	680

Legend for Table 8-7:
 NR=not required

Table 8-8
Surface danger zone parameters for 30mm MK238 MOD 1 HEI-T and MK266 MOD 1 HEI-T (Fighting Vehicle - Elevation Restriction)

Altitude (ft)	Impact media	Distance X (m)	Ricochet Angle P (deg)	Distance W (m)	Area A (m)	Area B (m)	Vertical hazard (m)
0	Armor Plate	6,000	17	750	175	175	575
	Earth	6,000	8	575	175	175	570
1,000	Armor Plate	6,140	17	765	175	175	590
	Earth	6,140	8	590	175	175	585
2,000	Armor Plate	6,280	17	780	175	175	605
	Earth	6,280	8	605	175	175	600
3,000	Armor Plate	6,420	17	795	175	175	620
	Earth	6,420	8	620	175	175	615
4,000	Armor Plate	6,590	17	825	175	175	636
	Earth	6,590	8	640	175	175	631
5,000	Armor Plate	6,760	17	855	175	175	652
	Earth	6,760	8	660	175	175	647
6,000	Armor Plate	6,930	17	885	175	175	668
	Earth	6,930	8	680	175	175	663
7,000	Armor Plate	7,100	17	915	175	175	685
	Earth	7,100	8	700	175	175	680

Table 8–9
Surface danger zone parameters for 30mm MK264 Multi-Purpose Low Drag (MPLD)-T (Fighting Vehicle - Elevation Restriction)

Altitude (ft)	Impact media	Distance X (m)	Ricochet Angle P (deg)	Distance W (m)	Area A (m)	Area B (m)	Vertical hazard (m)
0	Armor Plate	6,000	17	750	240	240	575
	Earth	6,000	8	575	240	240	570
1,000	Armor Plate	6,140	17	765	240	240	590
	Earth	6,140	8	590	240	240	585
2,000	Armor Plate	6,280	17	780	240	240	605
	Earth	6,420	8	620	240	240	615
3,000	Armor Plate	6,420	17	795	240	240	620
	Earth	6,420	8	620	240	240	615
4,000	Armor Plate	6,590	17	825	240	240	636
	Earth	6,590	8	640	240	240	631
5,000	Armor Plate	6,760	17	855	240	240	652
	Earth	6,760	8	660	240	240	647
6,000	Armor Plate	6,930	17	885	240	240	668
	Earth	6,930	8	680	240	240	663
7,000	Armor Plate	7,100	17	915	240	240	685
	Earth	7,100	8	700	240	240	680

Table 8–10
Surface danger zone parameters for 30mm MK310 Programmable Air Burst Munition (PABM)-T (Fighting Vehicle - Elevation Restriction)

Altitude (ft)	Impact media	Distance X (m)	Ricochet Angle P (deg)	Distance W (m)	Area A (m)	Area B (m)	Vertical hazard (m)
0	Armor Plate	6,000	17	750	150	150	575
	Earth	6,000	8	575	150	150	570
1,000	Armor Plate	6,140	17	765	150	150	590
	Earth	6,140	8	590	150	150	585
2,000	Armor Plate	6,280	17	780	150	150	605
	Earth	6,280	8	605	150	150	600
3,000	Armor Plate	6,420	17	795	150	150	620
	Earth	6,420	8	620	150	150	615
4,000	Armor Plate	6,590	17	825	150	150	636
	Earth	6,590	8	640	150	150	631
5,000	Armor Plate	6,760	17	855	150	150	652
	Earth	6,760	8	660	150	150	647
6,000	Armor Plate	6,930	17	885	150	150	668
	Earth	6,930	8	680	150	150	663
7,000	Armor Plate	7,100	17	915	150	150	685
	Earth	7,100	8	700	150	150	680

Table 8-11
Surface danger zone parameters for 30mm MK258 and MK268 APFSDS-T (Fighting Vehicle - Elevation Restriction)

Altitude (ft)	Impact media	Distance X (m)	Ricochet Angle P (deg)	Distance W (m)	Area A (m)	Area B (m)	Vertical hazard (m)
0	Armor Plate	13,300	17	375	NR	NR	445
	Earth	13,450	30	390	NR	NR	445
1,000	Armor Plate	13,700	17	392	NR	NR	452
	Earth	13,850	30	405	NR	NR	452
2,000	Armor Plate	14,100	17	409	NR	NR	458
	Earth	14,250	30	420	NR	NR	458
3,000	Armor Plate	14,500	17	425	NR	NR	465
	Earth	14,650	30	440	NR	NR	465
4,000	Armor Plate	14,875	17	438	NR	NR	471
	Earth	15,025	30	455	NR	NR	471
5,000	Armor Plate	15,250	17	451	NR	NR	478
	Earth	15,400	30	470	NR	NR	478
6,000	Armor Plate	15,625	17	464	NR	NR	484
	Earth	15,775	30	485	NR	NR	484
7,000	Armor Plate	16,000	17	475	NR	NR	490
	Earth	16,150	30	500	NR	NR	490

Legend for Table 8-11:
 NR=not required

Table 8-12
Surface danger zone parameters for MK239 TP- T 30mm (free gun - no elevation restriction)

Altitude (ft)	Impact media	Distance X (m)	Distance Y (m)	Ricochet Angle P (deg)	Ricochet Angle Q (deg)	Area W (m)	Area A (m)	Area B (m)	Vertical hazard (m)
0	Armor Plate	8,600	6,000	17	65	750	NR	NR	2,700
	Earth	8,600	6,000	8	65	575	NR	NR	2,700
1,000	Armor Plate	8,870	6,140	17	65	765	NR	NR	2,770
	Earth	8,870	6,140	8	65	590	NR	NR	2,770
2,000	Armor Plate	9,140	6,280	17	65	780	NR	NR	2,840
	Earth	9,140	6,280	8	65	605	NR	NR	2,840
3,000	Armor Plate	9,410	6,420	17	65	795	NR	NR	2,910
	Earth	9,410	6,420	8	65	620	NR	NR	2,910
4,000	Armor Plate	9,710	6,590	17	65	825	NR	NR	2,985
	Earth	9,710	6,590	8	65	640	NR	NR	2,985
5,000	Armor Plate	10,010	6,760	17	65	855	NR	NR	3,060
	Earth	10,010	6,760	8	65	660	NR	NR	3,060
6,000	Armor Plate	10,310	6,930	17	65	885	NR	NR	3,135
	Earth	10,310	6,930	8	65	680	NR	NR	3,135
7,000	Armor Plate	10,610	7,100	17	65	915	NR	NR	3,210
	Earth	10,610	7,100	8	65	700	NR	NR	3,210

Legend for Table 8-12:
 NR=not required

Table 8-13
Surface danger zone parameters for MK238 MOD 1 HEI-T and MK266 MOD 1 HEI-T 30mm (free gun - no elevation restriction)

Altitude (ft)	Impact media	Distance X (m)	Distance Y (m)	Ricochet Angle P (deg)	Ricochet Angle Q (deg)	Area W (m)	Area A (m)	Area B (m)	Vertical hazard (m)
0	Armor Plate	8,600	6,000	17	65	750	175	175	2,700
	Earth	8,600	6,000	8	65	575	175	175	2,700
1,000	Armor Plate	8,870	6,140	17	65	765	175	175	2,770
	Earth	8,870	6,140	8	65	590	175	175	2,770
2,000	Armor Plate	9,140	6,280	17	65	780	175	175	2,840
	Earth	9,140	6,280	8	65	605	175	175	2,840
3,000	Armor Plate	9,410	6,420	17	65	795	175	175	2,910
	Earth	9,410	6,420	8	65	620	175	175	2,910
4,000	Armor Plate	9,710	6,590	17	65	825	175	175	2,985
	Earth	9,710	6,590	8	65	640	175	175	2,985
5,000	Armor Plate	10,010	6,760	17	65	855	175	175	3,060
	Earth	10,010	6,760	8	65	660	175	175	3,060
6,000	Armor Plate	10,310	6,930	17	65	885	175	175	3,135
	Earth	10,310	6,930	8	65	680	175	175	3,135
7,000	Armor Plate	10,610	7,100	17	65	915	175	175	3,210
	Earth	10,610	7,100	8	65	700	175	175	3,210

Table 8-14
Surface danger zone parameters for MK264 MPLD- T 30mm (free gun - no elevation restriction)

Altitude (ft)	Impact media	Distance X (m)	Distance Y (m)	Ricochet Angle P (deg)	Ricochet Angle Q (deg)	Area W (m)	Area A (m)	Area B (m)	Vertical hazard (m)
0	Armor Plate	8,600	6,000	17	65	750	240	240	2,700
	Earth	8,600	6,000	8	65	575	240	240	2,700
1,000	Armor Plate	8,870	6,140	17	65	765	240	240	2,770
	Earth	8,870	6,140	8	65	590	240	240	2,770
2,000	Armor Plate	9,140	6,280	17	65	780	240	240	2,840
	Earth	9,140	6,280	8	65	605	240	240	2,840
3,000	Armor Plate	9,410	6,420	17	65	795	240	240	2,910
	Earth	9,410	6,420	8	65	620	240	240	2,910
4,000	Armor Plate	9,710	6,590	17	65	825	240	240	2,985
	Earth	9,710	6,590	8	65	640	240	240	2,985
5,000	Armor Plate	10,010	6,760	17	65	855	240	240	3,060
	Earth	10,010	6,760	8	65	660	240	240	3,060
6,000	Armor Plate	10,310	6,930	17	65	885	240	240	3,135
	Earth	10,310	6,930	8	65	680	240	240	3,135
7,000	Armor Plate	10,610	7,100	17	65	915	240	240	3,210
	Earth	10,610	7,100	8	65	700	240	240	3,210

Table 8-15
Surface danger zone parameters for MK310 PABM- T 30mm (free gun - no elevation restriction)

Altitude (ft)	Impact media	Distance X (m)	Distance Y (m)	Ricochet Angle P (deg)	Ricochet Angle Q (deg)	Area W (m)	Area A (m)	Area B (m)	Vertical hazard (m)
0	Armor Plate	8,600	6,000	17	65	750	150	150	2,700
	Earth	8,600	6,000	8	65	575	150	150	2,700
1,000	Armor Plate	8,870	6,140	17	65	765	150	150	2,770
	Earth	8,870	6,140	8	65	590	150	150	2,770
2,000	Armor Plate	9,140	6,280	17	65	780	150	150	2,840
	Earth	9,140	6,280	8	65	605	150	150	2,840
3,000	Armor Plate	9,410	6,420	17	65	795	150	150	2,910
	Earth	9,410	6,420	8	65	620	150	150	2,910
4,000	Armor Plate	9,710	6,590	17	65	825	150	150	2,985
	Earth	9,710	6,590	8	65	640	150	150	2,985
5,000	Armor Plate	10,010	6,760	17	65	855	150	150	3,060
	Earth	10,010	6,760	8	65	660	150	150	3,060
6,000	Armor Plate	10,310	6,930	17	65	885	150	150	3,135
	Earth	10,310	6,930	8	65	680	150	150	3,135
7,000	Armor Plate	10,610	7,100	17	65	915	150	150	3,210
	Earth	10,610	7,100	8	65	700	150	150	3,210

Table 8-16
Surface danger zone parameters for MK258 and MK268 APFSDS- T 30mm (free gun - no elevation restriction)

Altitude (ft)	Impact media	Distance X (m)	Distance Y (m)	Ricochet Angle P (deg)	Ricochet Angle Q (deg)	Area W (m)	Area A (m)	Area B (m)	Vertical hazard (m)
0	Armor Plate	30,800	18,500	17	15	375	NR	NR	18,705
	Earth	30,800	18,500	30	15	390	NR	NR	18,705
1,000	Armor Plate	32,965	18,665	17	15	392	NR	NR	19,625
	Earth	32,965	18,665	30	15	405	NR	NR	19,625
2,000	Armor Plate	35,130	18,830	17	15	409	NR	NR	20,545
	Earth	35,130	18,830	30	15	420	NR	NR	20,545
3,000	Armor Plate	37,300	19,000	17	15	425	NR	NR	21,465
	Earth	37,300	19,000	30	15	440	NR	NR	21,465
4,000	Armor Plate	39,925	19,250	17	15	438	NR	NR	22,530
	Earth	39,925	19,250	30	15	455	NR	NR	22,530
5,000	Armor Plate	42,550	19,500	17	15	451	NR	NR	23,595
	Earth	42,550	19,500	30	15	470	NR	NR	23,595
6,000	Armor Plate	45,175	19,750	17	15	464	NR	NR	24,660
	Earth	45,175	19,750	30	15	485	NR	NR	24,660
7,000	Armor Plate	47,800	20,000	17	15	475	NR	NR	25,730
	Earth	47,800	20,000	30	15	500	NR	NR	25,730

Legend for Table 8-16:
 NR=not required

Table 8-17
Sabot Surface danger zone parameters for MK 258 and MK268 APFSDS- T 30mm (all firing conditions)

Item	Distance Y (m)	Sabot Angle P (deg)	Sabot Angle Q (deg)	Area W (m)
MK258	250	15	90	30
MK268	175	30	90	40

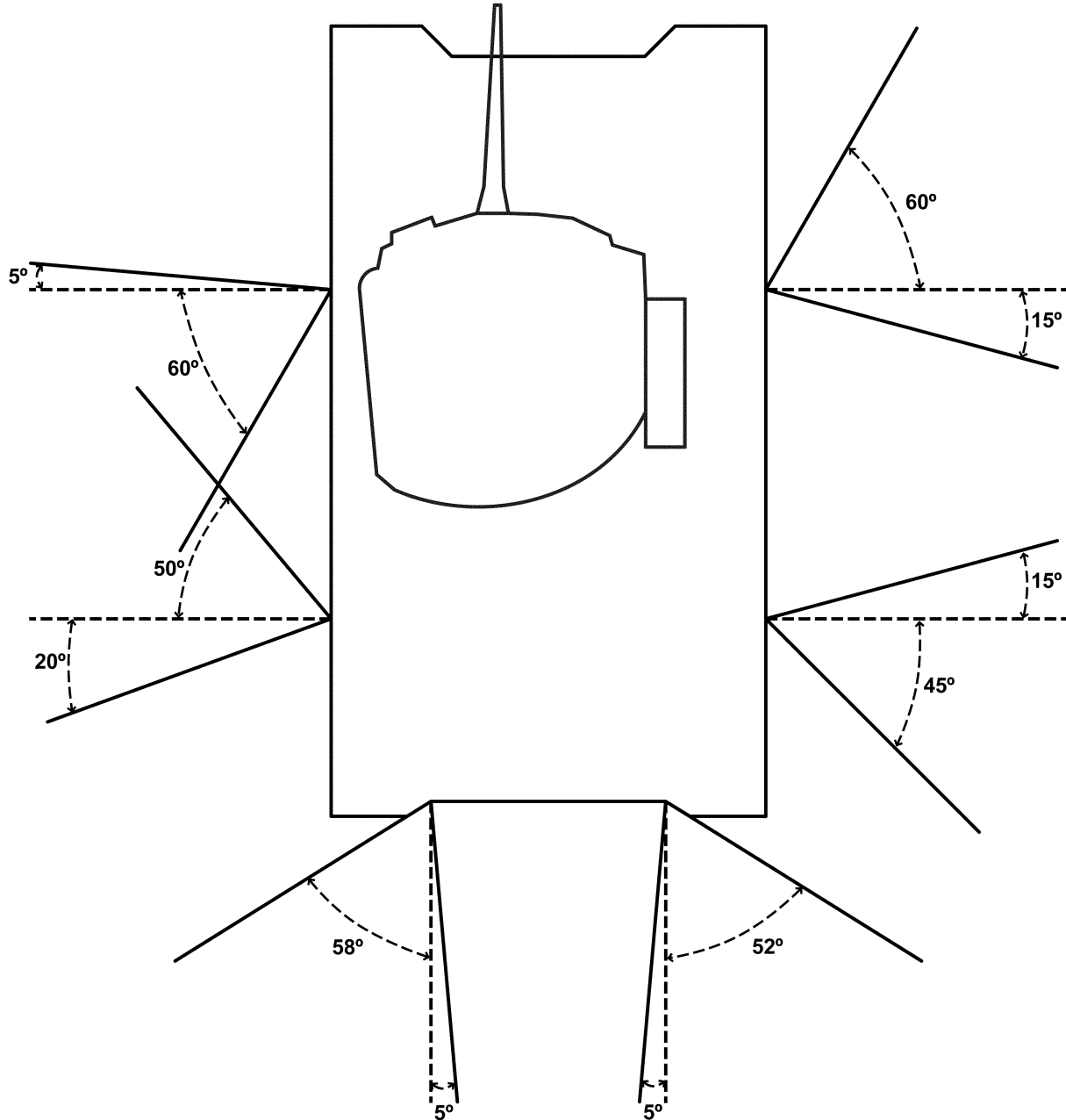

Figure 8-6. Surface danger zone for fighting vehicle firing port weapon systems

c. 25mm and 30 mm aluminum and plastic base Sabot discard hazard area information is provided in table 8-17 and figures 8-7, 8-8, and 8-9.

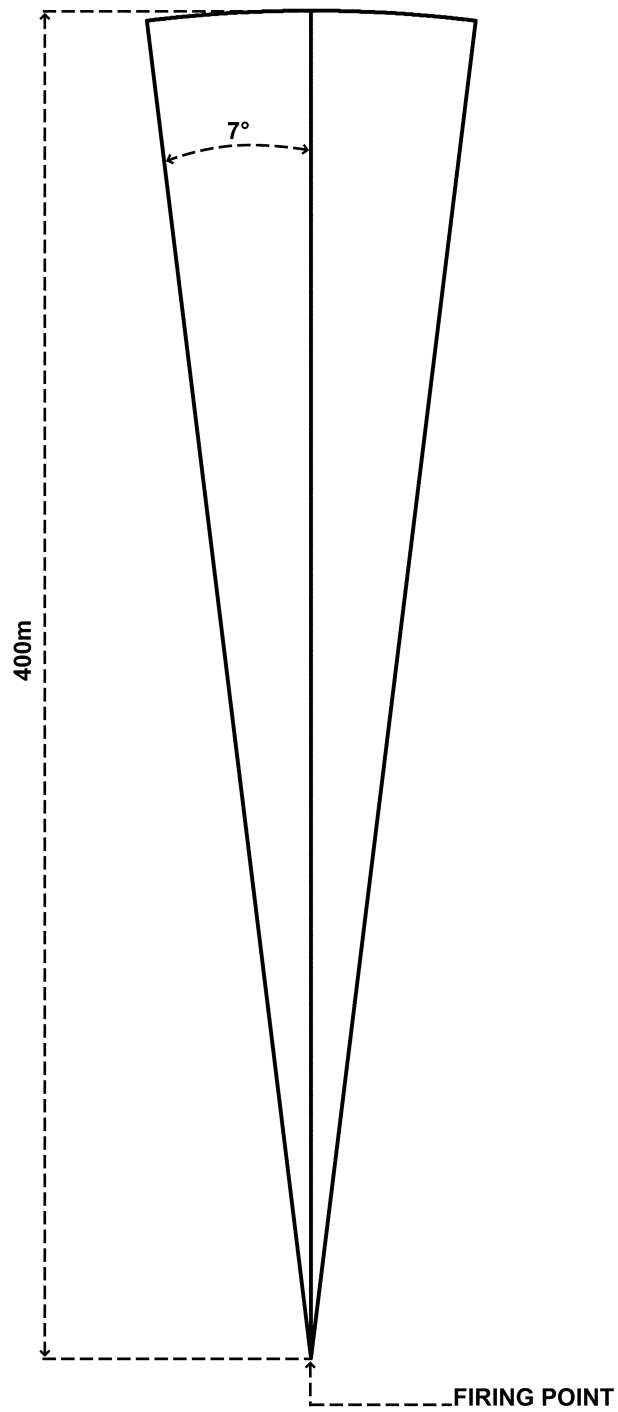

Figure 8-7. 25mm aluminum base Sabot discard hazard area

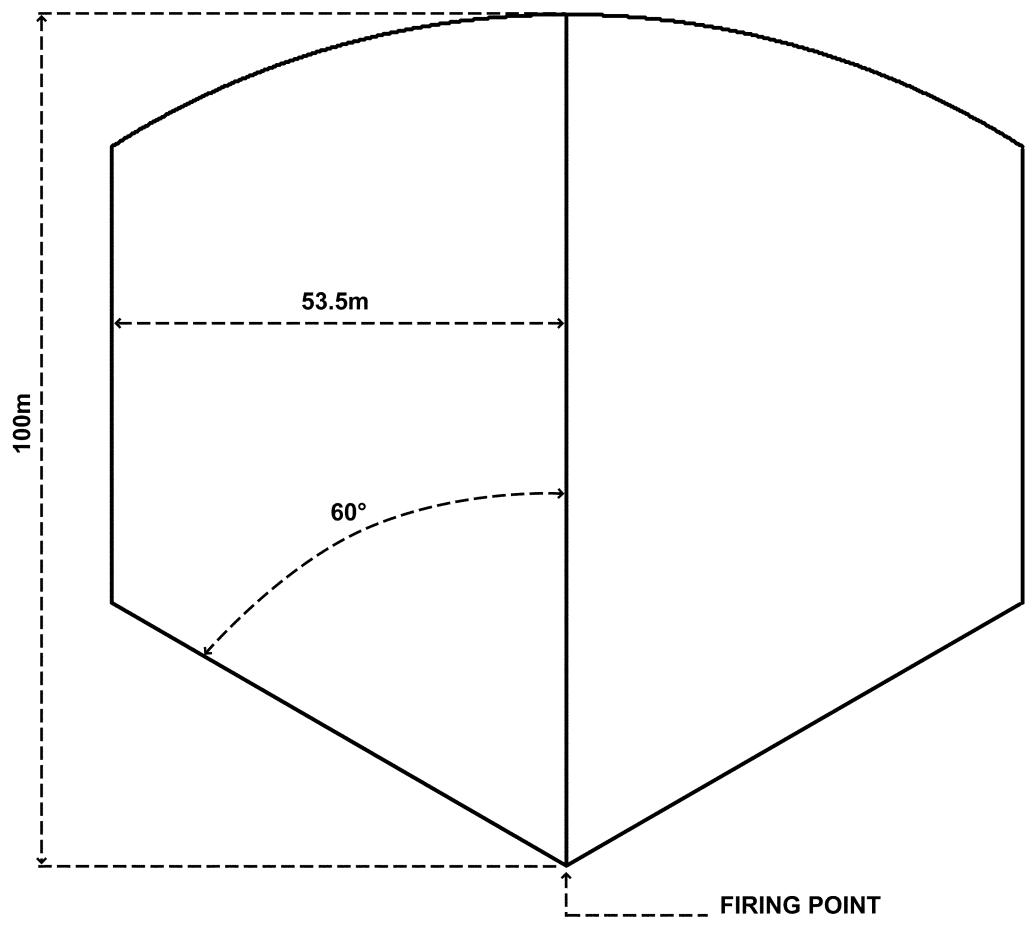

Figure 8-8. 25mm plastic base Sabot discard hazard area

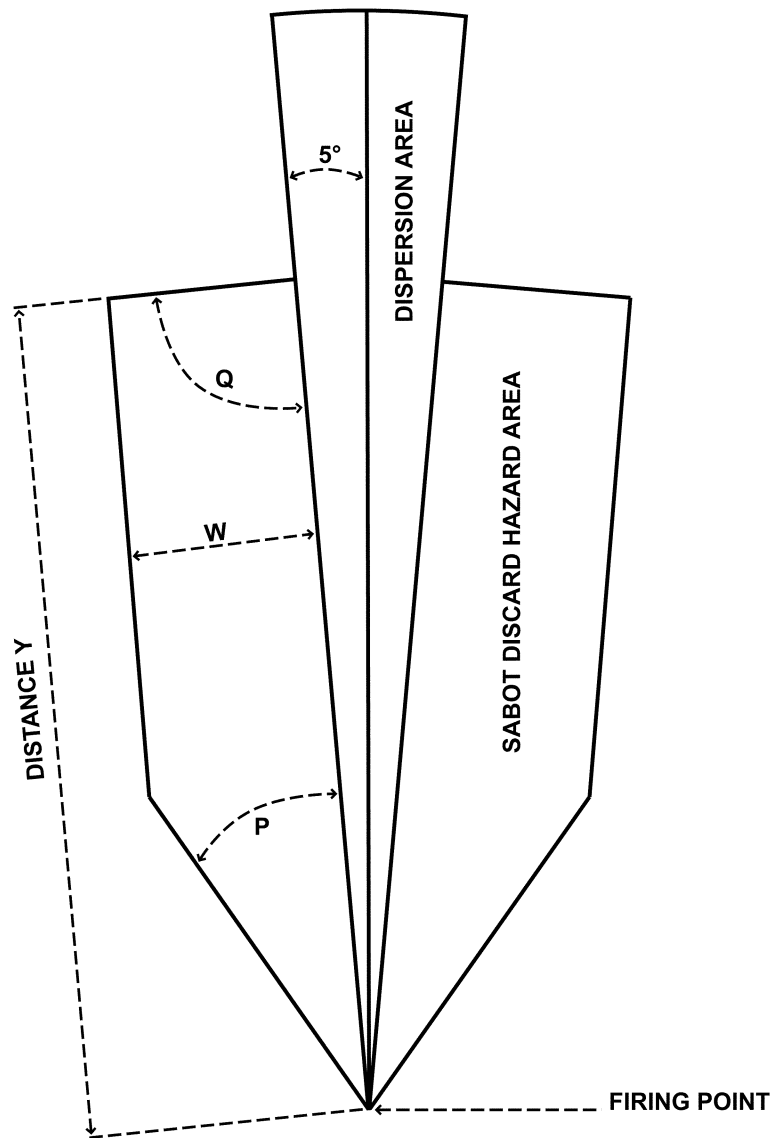

Figure 8-9. 30mm discard hazard area

8-4. Firing vehicle status designations

a. Safety precautions for firing vehicle status designations will be determined by appropriate risk authority based on risk assessment and training objectives. Use of flags and lights is an alternative safety precaution to reduce risk of accidental losses during training operations. The following color scheme is recommended when flags and/or lights are used:

- (1) Yellow: Vehicle has malfunction. Yellow is used only in conjunction with red or green.
- (2) Red and green: Vehicle is preparing to fire or the crew is performing a non-firing exercise. Weapon systems are clear but not elevated.
- (3) Red and yellow: Vehicle has a malfunction or misfire. Weapon systems are not clear and are pointed downrange.
- (4) Green and yellow: Vehicle has a malfunction. Weapon systems are clear.
- (5) Red: Vehicle engaged in firing. Weapons must be pointed at the target area.
- (6) Green: All vehicles' weapon systems are clear and elevated. Any live ammunition in the vehicle is properly stowed.

b. Once a firing vehicle begins a battle run and passes the start fire line, all weapon systems, including laser systems, are considered to be loaded and ready to fire. Senior commanders (Army)/installation commanders (Marine

Corps) may require vehicles on a battle run to display status flags or lights or other control measure based on a risk assessment.

c. When the firing vehicle completes a battle run, the tank/fighting vehicle commander will ensure the weapon systems have been cleared. The vehicle commander, RSO, or ARSO will mount the vehicle and verify weapon systems clearance, to include laser systems, before the vehicle moves off the firing line, out of the maneuver box, or out of a battle position to a designated position. Proper flags or lights may be displayed to identify the status of the weapons.

d. Tank/fighting vehicle commanders or RSOs will ensure the weapon systems are aligned within the envelope of the vehicle's width when traveling off-range onto roadways or tank/fighting vehicle trails, unless previously coordinated with range operations (Army), range control (Marine Corps) for purposes of tactical road marches.

8-5. Sub-caliber tank/fighting vehicle gunnery devices

a. SDZ will be constructed as shown in figure 8-2.

b. The dimensions in table 8-18 will be used based on munition caliber.

Table 8-18
Sub-caliber devices surface danger zone criteria

Ammunition/ Device	Impact media	Distance X at 10 degrees or less (m)	Distance W (m)	Angle P (deg)	Area A (m)	Area B (m)	Vertical hazard (m)
.22 caliber LR DVC-D17-53 caliber .22 in-bore	Earth/Water Steel/Concrete	1,073	155	24.00	NR	NR	96
		1,073	386	63.4	NR	NR	245
5.56 mm M856 Tracer Brewster DVC-D17-87	Earth/Water Steel/Concrete	2,250	260	28.0	NR	NR	261
		2,250	202	18.60	NR	NR	261
7.62 mm M80 Ball DVC-D17-87 (Brewster single shot)	Earth/Water Steel/Concrete	3,100	1,461	43.54	NR	NR	706
		3,100	861	20.04	NR	NR	447
.50 caliber M2 Ball MK211	Earth/Water Steel/Concrete	4,400	1,652	38.19	NR	NR	901
		4,400	714	16.03	NR	NR	478
.50 caliber SLAP M962 120 mm in-bore AIMTEST ¹	Earth/Water Steel/Concrete	6,069	1,149	48.05	NR	NR	See note 2
		6,069	1,149	48.05	NR	NR	See note 2

Legend for Table 8-18:

NR=not required

Notes:

¹ Data based on 7,000 ft mean sea level (MSL).

² Use value of Distance W until validated test data is available.

8-6. Grenade launchers

a. *Firing conditions.*

- (1) SDZ occupation by unprotected personnel in the open is prohibited.
- (2) Grenades will not be fired into strong head winds (19 km per hour (12 mph) and greater).
- (3) PPE Level 1 is recommended with hand protection for personnel within the SDZ. See table 2-2.
- (4) Clothing will fit snugly to prevent red phosphorous fragments from getting inside clothing, particularly around the neck, ends of sleeves and pockets.

b. *Surface danger zone.*

(1) The L8A1 and L8A3 grenades are designed to launch out 30 m from the vehicle before functioning. SDZ requirements for firing the L8A1 and L8A3 smoke grenades are provided in figure 8-10. Hazard distances of 125 m from the vehicle in the direction of fire, and 50 m to the rear will be applied in accordance with figure 8-10.

(2) SDZ requirements for the M176, M226, and M239 grenade launchers are provided in figure 8-11. Dimensions shown in figure 8-11 are for illustrative purposes only.

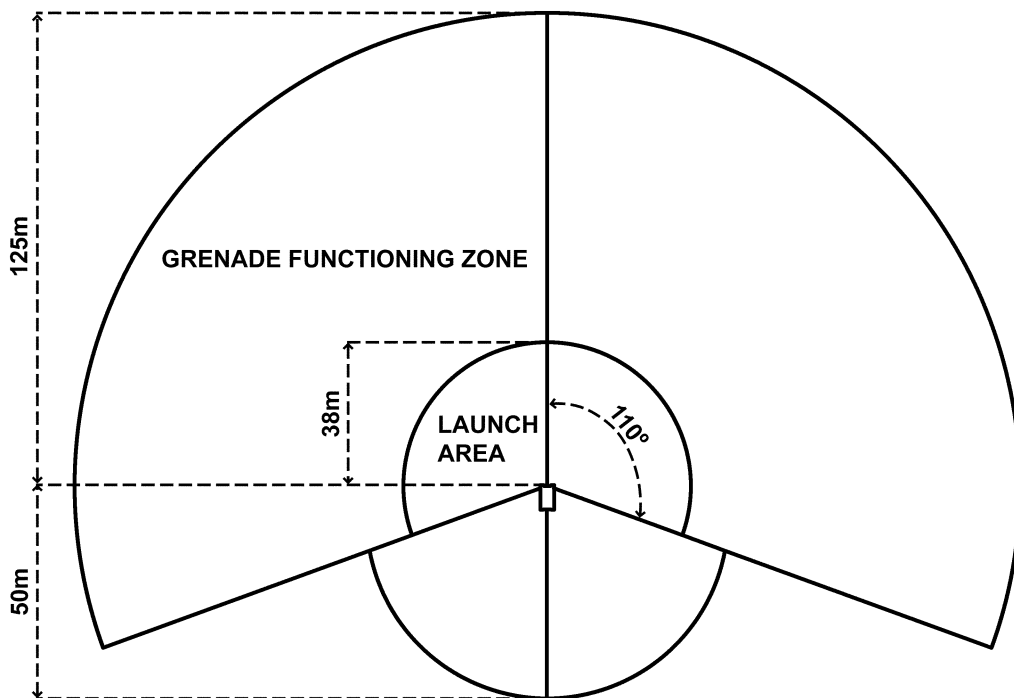

Figure 8-10. Surface danger zones for firing L8A1/A3 smoke grenades

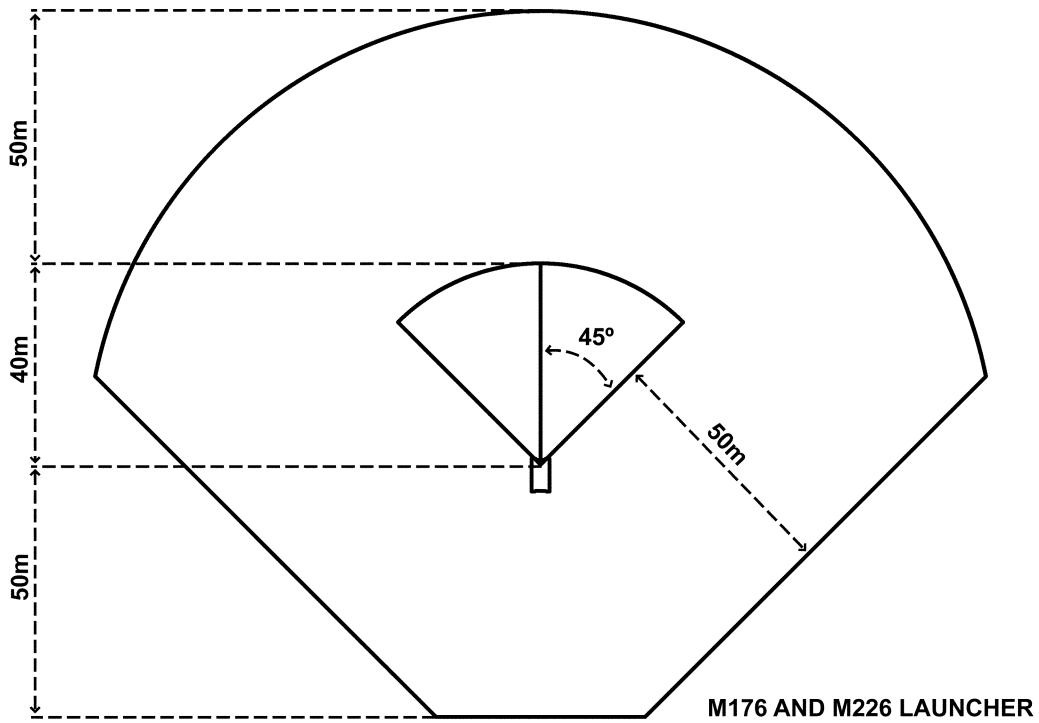
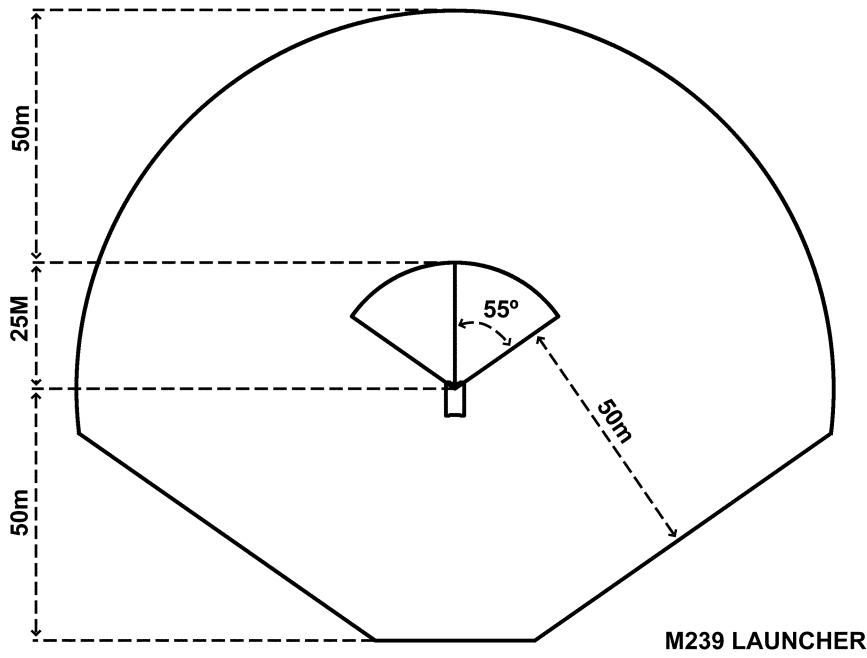

Figure 8–11. Surface danger zones for firing grenades from M176, M226, and M239 grenade launchers

(3) SDZ requirements for firing M81 grenades are provided in figure 8–12.

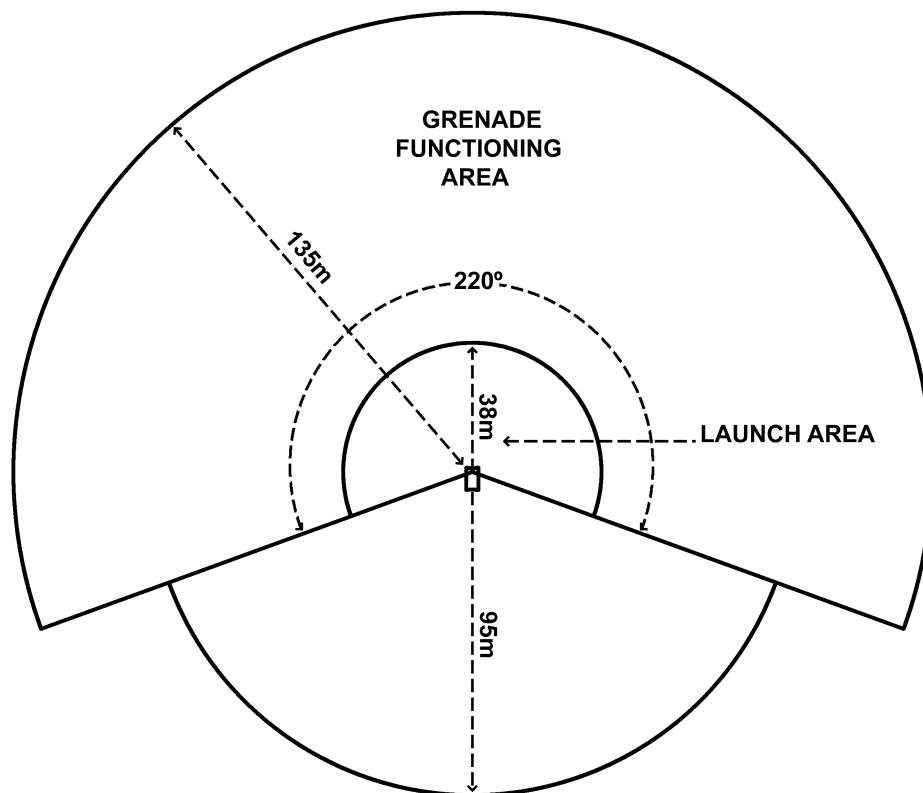

Figure 8–12. Surface danger zones for firing M81 grenade using standard 66mm launchers on armored vehicles

(4) SDZ requirements for firing M82 grenades are provided in figure 8–13.

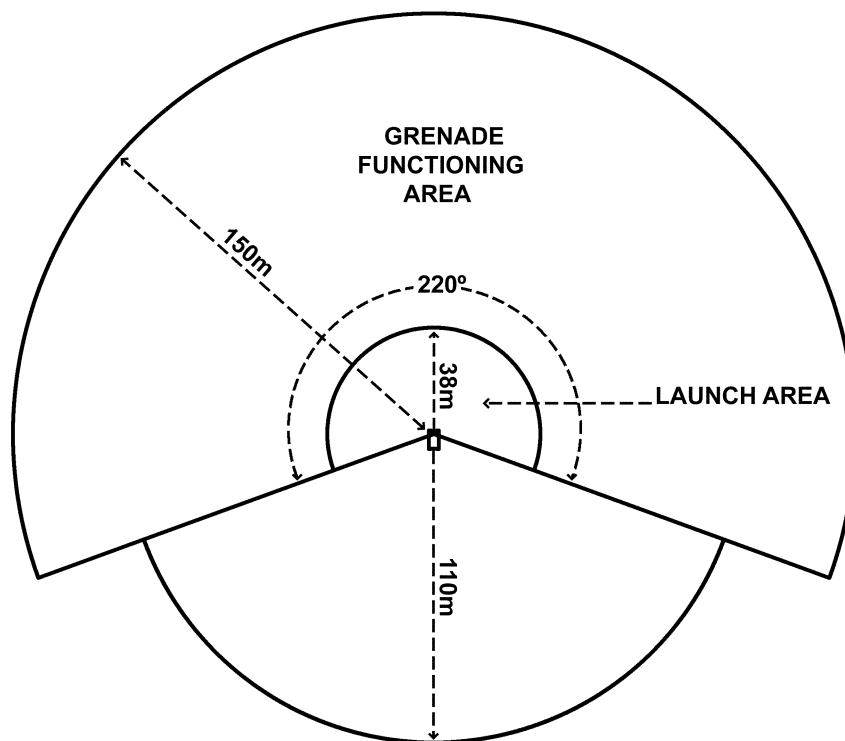

Figure 8–13. Surface danger zones for firing M82 grenades using standard 66mm launchers on armored vehicles

8–7. Close support of ground personnel

- a. Firing over the heads of unprotected personnel by tank and fighting vehicle main guns is prohibited.
- b. Tank/fighting vehicle weapons systems may be used to provide flanking fire if unprotected personnel remain out of the SDZ.
- c. Only personnel wearing approved single hearing protection will be allowed within 140 decibels peak (dBP) level contour zones during tank/fighting vehicle main gun firings.
- d. Nonparticipating personnel will be restricted from areas 10 m to the sides and from all areas forward of tanks/fighting vehicles.

8–8. Weapons effect signature simulator

Personnel within 25 m of the weapons effect signature simulator will wear approved single hearing protection. Eye protection will be worn.

8–9. Hazardous impulse noise exposure

- a. The driver's hatch must be closed tight at all times when the main weapon is fired. Exposure limits and contour distances to hazardous impulse noise in excess of 140 dBP from various 105mm and 120mm tank cannon cartridges are based on health hazard assessment reports. Tables 8–19 and 8–20 list exposure limits for tank/fighting vehicle main gun firings.
- b. Do not allow tank/fighting vehicle crew examiners or other personnel on the outside of a firing tank/fighting vehicle.

Table 8–19
Exposure limits to hazardous impulse noise from 105mm main gun cartridges (per 24 hours)

Cartridge caliber	Cartridge type	Commander exposed	Gunner exposed	Examiner exposed	Commander adjacent tank
105mm	M490A1	10	10	0	20

Table 8–20
Exposure limits to hazardous impulse noise from tank main gun for selected cartridges 120mm (per 24 hours)

Cartridge type	Firing condition	Single hearing protection ¹	Double hearing protection ²
		Maximum rounds per day	
M829A3 ³	Exposed commander	26	256
M829A3 ³	Driver	104	=1,000
M829A3 ³	Gunner	417	=1,000
M829A3 ³	Loader	=1,000	=1,000
M831 (TP–T)	Exposed commander	16	320
M831 (TP–T)	Exposed leader/evaluator	11	220
M831 (TP–T)	Rear deck	95	NPL
M831 (TP–T)	Interior commander (hatch open)	NPL	NPL
M831 (TP–T)	Interior driver (commander/leader hatch open)	NPL	NPL
M831 (TP–T)	Exposed commander adjacent tank	15	300
M831 (TP–T)	Exposed leader adjacent tank	15	300
M831A1 (TP–T)	Exposed commander	45	894
M831A1 (TP–T)	Exposed leader/evaluator	20	400
M831A1 (TP–T)	Rear deck	52	NPL
M831A1 (TP–T)	Interior commander (hatch open)	215	NPL
M831A1 (TP–T)	Interior driver (leader/evaluator hatch open)	73	NPL
M831A1 (TP–T)	Exposed commander adjacent tank	65	NPL
M831A1 (TP–T)	Exposed leader adjacent tank	66	NPL
M865 (TPCSDS–T)	Exposed commander	0	0
M865 (TPCSDS–T)	Exposed leader/evaluator	0	0
M865 (TPCSDS–T)	Rear deck	13	260
M865 (TPCSDS–T)	Interior commander (hatch open)	27	549
M865 (TPCSDS–T)	Interior driver (leader/evaluator hatch open)	NDA	NDA
M865 (TPCSDS–T)	Exposed leader/evaluator adjacent tank	ENA	0
M865 (TPCSDS–T)	Exposed leader adjacent tank	0	0

Legend for Table 8-20:

ENA=exposure not allowed

NDA=no data available

NPL=no practical limit

TP–T=target practice-tracer

TPCSDS–T=target practice, cone-stabilized discarding sabot-tracer

Notes:

¹ Single hearing protection includes approved earplugs, earmuffs, combat vehicle crewman (CVC) helmet, or headset.

² Double hearing protection includes use approved earplugs in combination with earmuffs, CVC helmet, or headset.

³ Ammunition is a wartime round. Information is advisory only. Projectile contains depleted uranium (DU) penetrator.

c. Numerous health hazard assessment reports define hazardous impulse noise contours for various tank/fighting vehicle main gun and secondary armament cartridges exceeding 140 dBP. Table 8–21 summarizes these contour requirements and figure 8–14 illustrates the hazardous impulse noise contours in relation to the GTL. Double hearing protection shall be worn when exposure is expected to be in excess of the daily exposure limit. Use of double hearing protection increases the daily exposure limits as determined by The Surgeon General. Loader may not have their head protruding above the open hatch while firing the main gun. Data for locations forward of tank/fighting vehicle weapon systems are not available. Impulse noise levels in front of tank systems are expected to be higher than to the sides and rear.

Table 8–21
Hazardous impulse noise contours for various tank/vehicle cannon cartridges

Cartridge	Caliber (mm)	Distance to 140 dBP contours (meters)		
		90 degrees	135 degrees	180 degrees
M490	105	501	NDA	NDA
M490A1	105	400	NDA	200
M831	120	444	314	152
M865	120	501	355	NDA
M968	35	130	NDA	NDA
All	.50 cal	32	16	NDA
All	7.62	15	7	NDA

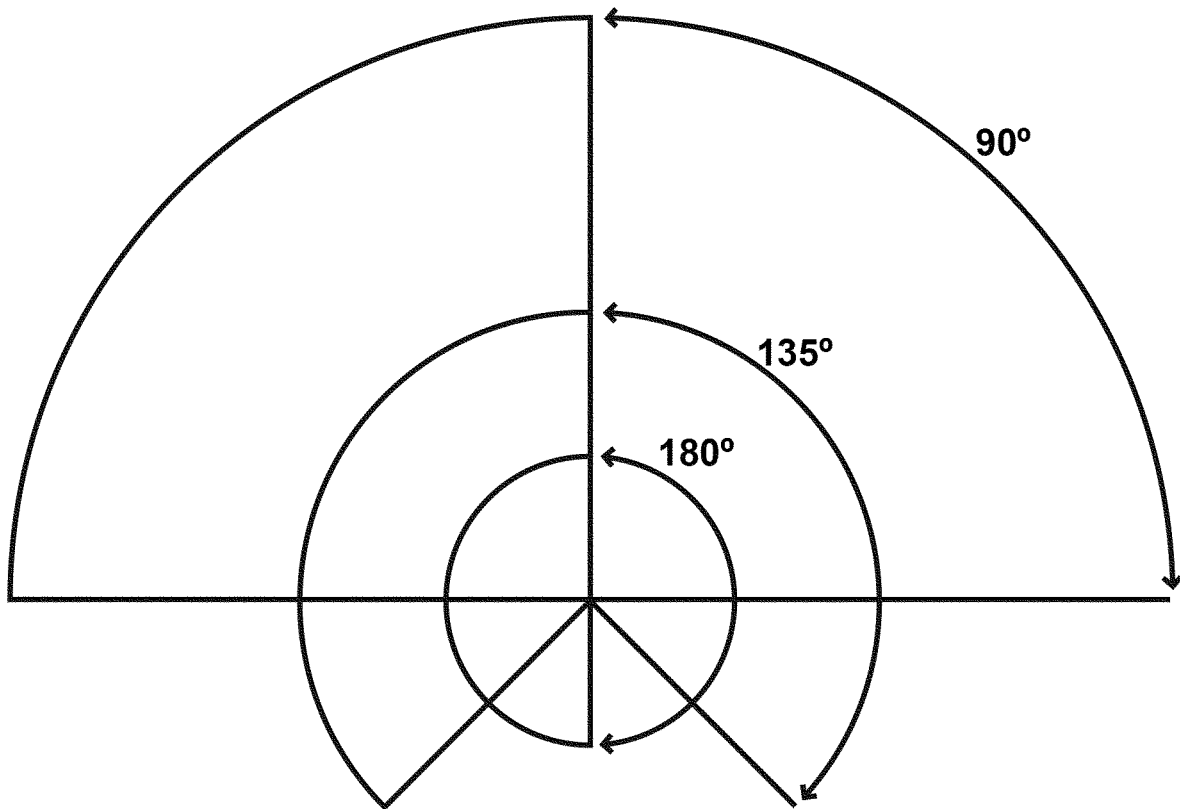

Figure 8–14. Hazardous impulse noise 140 dBP contour zones

Chapter 9 Mortars

9-1. Firing conditions

a. Firing mortars over the heads of unprotected troops by Army units is not recommended. Mortar ammunition must be certified for overhead fire of unprotected troops. The senior commander may approve overhead fire of unprotected troops with certified overhead fire mortar ammunition on the basis of acceptable level of risk. Procedural controls to prevent human error (for example, dedicated observer-controllers with the unprotected troops and firing mortars with dedicated communications) will be included in the risk management process.

b. Firing mortars over the heads of troops by Marine Corps units is not authorized except when firing the Expeditionary Fire Support System (EFSS) M327 120mm rifled towed mortar. For the Marine Corps, mortars must be fired at the edge of a high hazard impact area. Requirements for overhead fire using the 120mm rifled towed mortar can be found in chapter 10.

c. Overhead fire is allowed when Soldiers are in tanks with hatches closed 100 m or more from the line of fire.

d. All personnel who take part in mortar firing will wear, for the Army, a minimum of IBA and helmet; for the Marine Corps, PPE Level 1. Refer to table 2-2. At the commander's discretion, the gunner may remove their protective helmet while sighting the mortar. All personnel within the hearing hazard zone for the mortar, cartridge, or charge increment used will wear approved single hearing protection. The hearing hazard zone is usually defined in the manuals for the mortar or cartridges. If the hearing hazard zone information cannot be determined, single hearing protection will be required within 200 m.

e. Propellant increments removed from rounds before firing will be placed in metal or wooden covered (water-proofed) containers located outside the firing vehicle or positioned a distance of at least 25 m from the firing point when firing dismounted. Unused powder increments must be safeguarded and handled in accordance with installation range and environmental regulations.

f. M720, M721, M722, and M888 cartridges will not be fired above propellant charge 2 in the M2/M19 (60mm) mortar.

g. No mortar cartridges will be fired in the hand-held mode with a charge greater than charge 1.

h. No 800 series cartridges may be fired in the M29 (81mm) mortar except the M880 short-range target practice round. This also applies when using the M303 insert.

i. When firing the 120mm mortar from the carrier, all crew members and personnel inside the carrier must wear double hearing protection. Double hearing protection is required regardless of the carrier ramp position (opened or closed). Double hearing protection is defined as any approved earplugs plus either a CVC helmet or a communication aural protective system/artillery communication aural protective system with personnel armored system for ground troops helmet. Personnel outside the carrier within 200 m must wear single hearing protection.

j. Crew members and all personnel within 5 m of the 120mm mortar must wear double hearing protection when firing.

k. When firing the 120mm ground mount and carrier mount configuration, using the M933E1 HE cartridge, all personnel within 5 m of the mortar are required to wear double hearing protection. Exposure is limited to 140 rounds in any 24 hours.

l. Firing restrictions and limitations in TM 43-0001-28 apply to all cartridges and fuzes. Marine Corps fires will observe restrictions in TM 08655A-10A for light armored vehicle-mortar variants.

m. The target engagement distance will not be less than the distance required for Area B of the respective caliber of mortar to be fired, unless fired from protected positions.

9-2. Surface danger zones

a. SDZ requirements for 60mm, 81mm, and 120mm mortars are provided in table 9-1 and figure 9-1.

b. Distance X is the maximum range of the weapon system at a given charge. Distance X will not be less than the maximum range of the greatest charge to be fired. Distance X may be past the downrange edge of the target area.

c. Basic dimensions of the impact area will be computed as specified in table 9-2.

d. Firing table probable errors corresponding to the maximum range of charge employed will be used for this computation. These basic dimensions are based on standard conditions. They do not compensate for errors or nonstandard conditions.

e. To compute the probable errors in range and deflection, multiply the constant (listed in tab 9-2 and fig 9-1) by the data found in the tabular firing tables. These data are drawn in meters from the downrange edge of the target area for deflection probable errors (PE_D) and from Distance X for range probable errors (PE_R).

f. When firing ammunition with explosive warheads at distances equal to or less than the lateral hazard area (Area A), the angle between the weapon target line/lateral limits and the firing point will increase by the width of Area A.

g. The 25 degree angle for Area A must be increased to 70 degrees when firing HE ammunition at ranges equal to or less than 600 m for 60mm mortars; 940 m for 81mm mortars; and 1500 m for 120mm mortars. Only the personnel required to fire the mortar system are authorized to be within this area.

h. Only the mortar crew are authorized to be in Area A.

Table 9-1
Mortar surface danger zone criteria (in meters)^{1, 2, 3}

Caliber	Area A	Area B
60mm	250	300
81mm	400	400
120mm	600	600

Notes:

¹ Quadrant elevation limits must be modified to take into account the distance to the minimum and maximum limits of the impact area. After registration, corrections must be applied to the deflection quadrant elevation limits.

² Dimensions of Areas A and B may be reduced by 50 percent when firing illumination cartridges.

³ Cartridges without HE filler (for example, M880, M931) do not require Areas A and B.

Table 9-2
Basic impact area dimensions

Limits	Dimensions
Left	Eight deflection probable errors (PE _D) from the left limit of target area
Right	Eight PE _D from the right limit of target area
Far edge	Eight range probable errors (PE _R) downrange from distance X

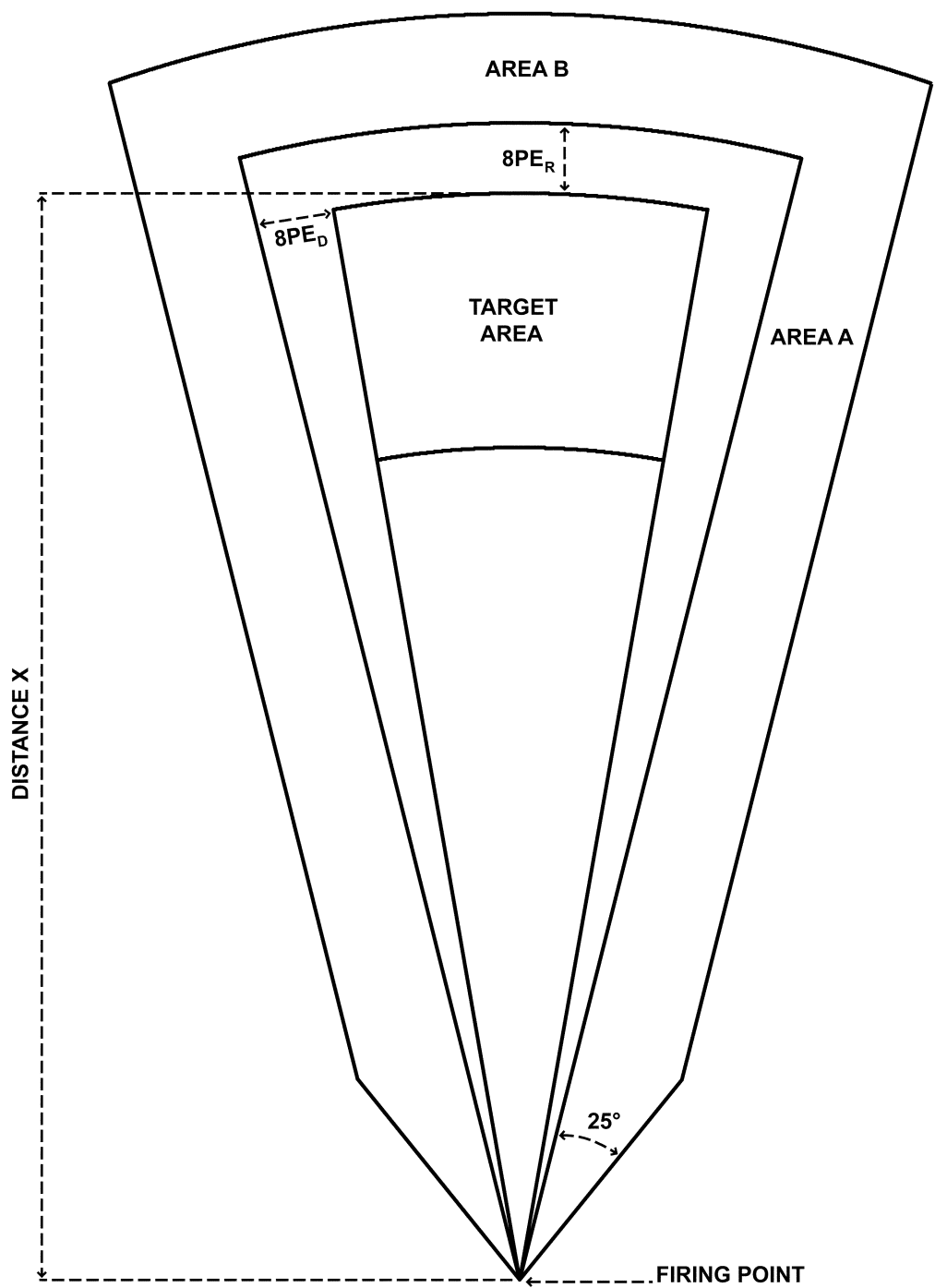

Figure 9-1. Surface danger zone for firing mortars

Chapter 10 Field Artillery

10-1. Procedures and precautions

This chapter contains procedures and precautions required to fire cannon, rocket field artillery, and the EFSS M327 mortar (spin-stabilized).

10-2. Safety certification program

a. Commanders of field artillery units, battalion and above, will establish and maintain an artillery safety training and annual certification program.

b. Field artillery commanders will determine, select, train, and safety certify personnel necessary to assist them in discharging this responsibility. These personnel will include, but are not limited to, the firing battery commander, executive officer or platoon leader, fire direction officer, chief of firing battery or platoon sergeant, gunnery sergeant, chief fire direction center computer, and howitzer or launcher chief of the section. These positions will be filled by command safety certified individuals. Their duties shall be as described in the appropriate FMs.

c. A separate battery safety officer is not required during the firing of field artillery, but commanders may appoint one.

10-3. Field artillery cannons

a. *Firing conditions.*

(1) Procedures will be established for weapon systems producing blast overpressure hazards to reduce the risk to artillery crews from auditory and internal injury caused by blast overpressure from specific charges. Individuals who experience shortness of breath, chest discomfort, bleeding from mouth, nose or ears, or excessive shakiness (tremors) when exposed to weapon system firings may be suffering from a blast overpressure injury. Individuals with any of these symptoms shall be instructed to lie down and remain quiet and immobile. Injured personnel will be transported to the nearest medical facility for immediate evaluation and treatment. Firing procedures for specific weapon systems can be found in appropriate TMs.

(2) Lanyards will not be attached to the firing mechanism of field artillery cannons that use separate loading ammunition until directed by the section chief.

(3) Unused powder increments must be safeguarded and handled in accordance with appropriate TMs and installation range regulations.

(4) All personnel immediately engaged in artillery operations will wear a minimum of PPE Level 1, as referenced in table 2-2.

b. *Fuzes.*

(1) Alteration of fuzes is not authorized unless authorized by the CG, AMC and supervised by a qualified AMC commissioned officer, WO, or civilian. For the Marine Corps, alteration of fuzes is not authorized unless authorized by Marine Corps System Command.

(2) Protect points of fuzes from blows or damage when handling ammunition because the closing cap may be sufficiently deformed and may activate the percussion primer in the fuze. Personnel inserting rounds of ammunition into cannons will be cautioned to keep each projectile away from the path of cannon recoil until recoil from the previous projectile is complete.

(3) Screw the fuze down by hand and firmly seat with the fuze wrench.

(4) Projectiles removed from cannons with ramming staffs will not be reused.

(5) All projectiles fired during training will be fuzed with bore safe fuzes.

(6) Fuzed projectiles fired during training exercises will be of the type that precludes close-in premature bursts that would present a fragment and debris hazard to the firing crew. Other type fuzes require all personnel within Area A distance from the firing position to be provided positive protection against premature bursts. When only white phosphorous (WP) ammunition is involved, this distance may be reduced to 200 m for positive protection from premature bursts. Positive protection at the weapon system position will meet the minimum requirements of four thicknesses of sandbags filled with dry, sifted sand stacked high enough for protection against all calibers of ammunition, or trenches deep enough to provide complete protection, or concrete walls 0.30 m thick, or tanks with hatches closed.

(7) Firing projectiles without fuzes is unauthorized.

c. *Malfunctions.*

(1) Malfunctions that occur during firing of ammunition will be investigated in accordance with AR 75-1 or MCO 8025.1E.

(2) Procedures to be followed when a misfire or hang-fire occurs, or when the potential for a cook-off exists, are in the appropriate weapon system TMs.

(3) All dud projectiles and their location will be reported to the installation RMA (Army), RCO (Marine Corps).

d. Loading or firing ammunition. Do not load or fire ammunition at bore temperatures higher or lower than the safe limit of firing. After loading, fire the weapon system, or in case of a cease-fire, immediately remove the projectile. If the projectile cannot be removed from the weapon system within five minutes, evacuate all personnel to a distance equivalent to Area A for the munitions. See TM 43-0001-28 and appropriate weapon system TMs.

e. Authorized propellant charge. Use only authorized propellant charges for the specific projectile and weapon system to be fired. Never use more charges than those comprising the full authorized charge.

f. White phosphorous impregnated felt wedges from the M825 and M825A1 155mm projectiles. These may not be totally consumed when the WP burns. Crushing or moving unburned felt wedges would reignite residual WP posing a burn hazard. Personnel will not disturb unburned felt wedges. Personnel discovering unburned felt wedges will notify the range operations firing desk (Army), range control (Marine Corps).

g. Rocket assisted projectiles. Rocket-on firings require a clear zone short of the target area in case the rocket motor fails to function. Rocket-off firings also require a clear zone beyond the target area to allow for accidental (unintended) initiation of the rocket motor. 105mm rocket assisted projectiles require a clear zone of 5,000 m short of the target for rocket-on firing and 5,000 m beyond the target for rocket-off firing. 155mm rocket assisted projectiles require a 7,000 m clear zone short of the target for rocket-on firing and 7,000 m beyond the target for rocket-off firing.

h. Salute (blank) firing of 75mm and 105mm projectiles. DODICs B550, B650, C025, C440 produce hazards from muzzle debris and noise. Muzzle closure debris can be expelled 92 m forward of the weapon and 10 degrees either side of the bore axis. Hazardous noise levels (140 decibels) are 77 m along the bore axis, 49 m at 30 degrees each side of the bore axis, 31 m at 60 degrees each side of the bore axis, 21 m at 90 degrees each side of the bore axis, 14 m at 120 degrees each side of the bore axis, 10 meters at 150 degrees each side of the bore axis, and 10 m directly behind the weapon.

i. Hearing protection. All personnel within the hearing hazard zone shall wear approved single hearing protection. The hearing hazard zone is usually defined in the manuals for the cannon, propellant charges, or cartridge. If the hearing hazard zone information cannot be determined, hearing protection will be required within 800 m.

10-4. Field artillery cannon surface danger zones

a. The SDZ requirements for all field artillery cannons firing conventional ammunition (excluding APERS/"beehive" and M712 Copperhead cannon-launched guided projectiles) are provided in tables 10-1 and 10-2 and figures 10-1 and 10-2.

b. Computer-generated SDZs created using the RMTK are authorized if the software has been thoroughly tested and validated by survey and manual computations, approved for use by the artillery commander who trains the unit, and reviewed and verified by the installation RMA (Army), RCO (Marine Corps). Tactical fire control measures may be substituted for SDZs provided they correspond to figures 10-1 or 10-2 as applicable.

c. Installation RMAs (Army), RCOs (Marine Corps) will determine target area boundaries. Left and right limits of the target area determine the left and right limits of fire. The maximum range line (arc) will be the far edge (down range) of the target area, and the minimum range line (arc) will be the near edge (up range) of the target area. Unprotected personnel are not authorized in the target and associated hazard areas (Areas A, B, C, and E) during firing.

d. Projectile ricochets, empty carrier projectile bodies and debris found outside the Target Area in or beyond Area A and Area B and their locations will be reported to the installation RMA (Army), RCO (Marine Corps).

e. Basic dimensions of the impact area will be computed as specified in table 10-1.

f. Firing table probable errors corresponding to the range for the center of the target area will be used for this computation. These basic dimensions are based on standard conditions. They do not compensate for errors or nonstandard conditions.

g. Areas A and B for M825 155mm WP smoke projectiles may be reduced to 350 m.

Table 10-1
Basic impact area dimensions for field artillery cannons

Limits	Dimensions
Left	Eight PE _D) from the left limit of target area.
Right	Eight PE _D) from the right limit of target area.
Far edge	Eight PE _R) from the down range edge of target area.
Near edge	Twelve PE _R) from the up range edge of target area.

Table 10-2
Field artillery cannon surface danger zone criteria

Caliber	Area A ¹ (m)	Area B ¹ (m)	Area C low angle ² (m)	Area C high angle, time, VT ² (m)	Area E (m)	Direct fire mode ³ (m)
105mm howitzer	550	550	300	350	550	650
155mm howitzer	725	725	350	550	725	750

Legend for Table 10-2:

VT=variable time

Notes:

¹ Dimensions of Areas A and B may be reduced by 50 percent when firing illumination projectiles. This reduction of Areas A and B by 50 percent does not apply to the M1064 105mm infrared illumination projectile.

² When the headings of more than one column above relate in some way to the type of firing to be conducted, the column giving the larger value of Area C will be used.

³ Distances in this column represent minimum target engagement distances when personnel at the firing position are unprotected.

h. Weapon system crews firing from approved tactical configurations are authorized access to Area E. Operational and range operations (Army), range control (Marine Corps) personnel involved in firing exercises with a valid need to enter Area E may do so at the approval of the installation RMA (Army), RCO (Marine Corps). Based on risk assessment of firing conditions, the installation RMA (Army), RCO (Marine Corps) may reduce Area E to not less than 300 m for 105mm and 350 m for 155mm weapons.

i. When firing in the direct mode, Distance X will not be less than the range of the weapon system corresponding to a QE of 15 degrees for a given charge.

j. Area C is increased to 2,400 m when firing M107 HE ammunition filled with (trinitrotoluene) TNT.

10-5. Bunkers and fighting vehicles

a. Light field artillery fire, up to and including 105mm howitzer, may impact no closer than 100 m to occupied bunkers. Medium and heavy field artillery fire above 105mm may impact no closer than 200 m to occupied bunkers. Ammunition certified for overhead fire must be used. Bunkers must have been constructed and approved to protect personnel from a direct hit by the ammunition being fired. Constant communication must be maintained between the firing position and bunkers. Observation from bunkers will be by indirect viewing such as periscopes unless an approved design for direct viewing has been provided.

b. Bunkers to be used in accordance with paragraph 10-5*a* will be designed and constructed using specifications provided by the facility engineer. The installation engineer will review designs before final approval to ensure that structural integrity is maintained against direct hits and penetrating fragments. Direct viewing methods will be designed and constructed according to specifications provided by the facility engineer.

c. Personnel occupation of Areas A, B, and C is not authorized except when bunkers are constructed in accordance with paragraph 10-5*a*. Personnel access to Area C is not authorized unless protective cover exists that is designed in accordance with paragraph 10-5*a*, for positive protection against a direct hit. Tanks and fighting vehicles with hatches closed are permitted in Area C when field artillery ammunition is fired overhead with variable time (VT) or time fuzes. Height of burst data in table 10-3 will be used to provide an adequate degree of safety to protect personnel and materiel from ammunition fired with VT or time fuzes. The following procedures apply when firing over tanks and fighting vehicles:

(1) Do not use weapon systems of calibers greater than 155mm.

(2) Use sufficient QE so that if the time element of the fuze fails to function, the projectile will land beyond the tank or fighting vehicle at a distance equal to the predicted height of burst plus four PE_R.

(3) Only certified ammunition (projectiles, propellant/tailcharge, and fuzes) will be fired over the heads of unprotected personnel.

Table 10–3
Heights of burst above occupied fighting vehicles

Vehicle	Distance 105mm (m)	Above vehicle 155mm (m)
Fighting vehicles ¹	125	150
M1/M1A1 Tank	40	55

Notes:

¹ Fighting vehicles include the M106, M109, M113, M125, M577, M2, M3, Stryker, Light Armored Vehicle, and Amphibious Assault Vehicle.

10–6. Overhead fire

a. Overhead fire of unprotected personnel located in Area D is authorized during training provided certified ammunition for overhead fire (projectile, propellant/tailcharge, and fuze) is used. (For the Marine Corps' EFSS M327 mortar, only the M1101 HE, M1103 WP, and M1105 Illumination projectiles with M237 tailcharge are authorized for overhead fire.) Senior commanders (Army)/installation commanders (Marine Corps) may authorize nonparticipating personnel access to Area D during indirect field artillery and EFSS 120mm (rifled) mortar firing. When public highways pass through Area D, coordination with appropriate government officials (Federal, State, and/or local) and/or land owner(s) is required. When public roadways and railways pass through Area D, the following precautions apply:

(1) Projectile trajectories must clear unprotected personnel or objects by at least 5 m plus two forks. If the minimum range line (arc) is greater than the distance to the near edge of the target area, use the computed minimum range line (arc) for the near edge of the target area.

(2) Unless personnel are provided cover designed to withstand a direct hit, the minimum arming time of the proximity (VT) fuze establishes the near edge of the impact area. The minimum arming time of the proximity (VT) fuze will be the time set on the fuze corresponding to the range to the near limit of the impact area or computed minimum range line, whichever is greater, plus 5.5 seconds.

(3) Forward movement of personnel within Area D requires that the SDZ advance according to the distance and direction of the personnel. If proximity or VT fuzes with adjustable arming times are used, forward movement of personnel is possible. VT fuze time settings will correspond to the range to the near limit of the impact area plus 5.5 seconds.

(4) Warnings that field artillery projectiles may be fired at any time of the day will be posted on public roadways approved for overhead fire that passes through an installation or community.

b. If rocket assisted projectiles will be fired over the heads of unprotected troops during training exercises, ensure compliance with provisions of paragraph 10–3g.

10–7. Expeditionary Fire Support System M327 120mm rifled towed mortar

For the Marine Corps, the EFSS M327 120mm rifled towed mortar uses an SDZ similar to that of an artillery weapon system when firing spin-stabilized ammunition. Table 10–4 and figure 10–1 will be used to construct the SDZ for the EFSS M327 120mm rifled towed mortar. When firing fin-stabilized ammunition from the EFSS M327 120mm rifled towed mortar, use the SDZ in figure 9–1 and the data from table 9–1.

Table 10–4
Expeditionary Fire Support System 120mm (rifled) mortar surface danger zone criteria (Marine Corps)

Surface danger zone dimensions for EFSS mortar			
Area A (m)	Area B (m)	Area C (m)	Area E (m)
312	312	312	350

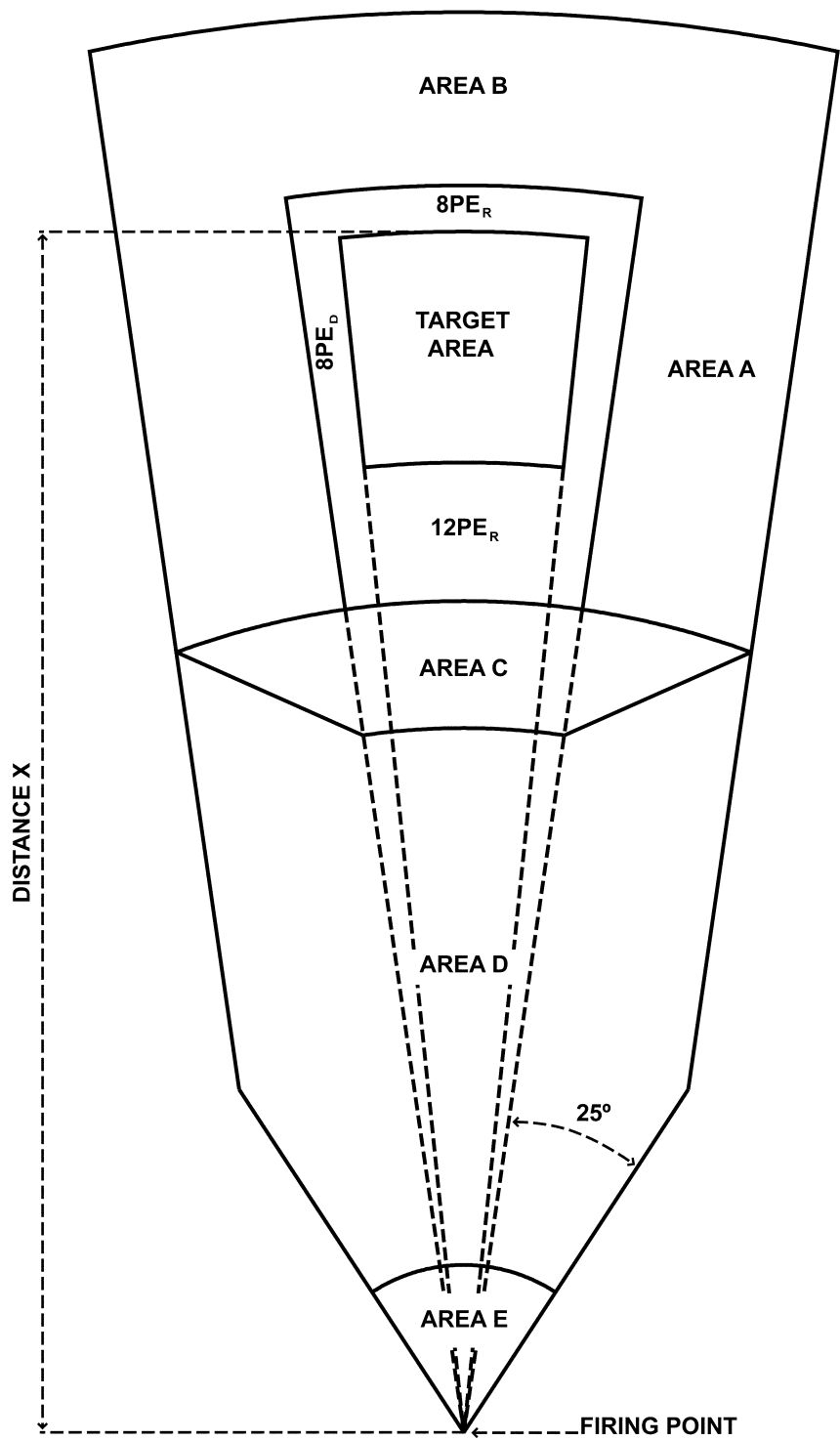

Figure 10-1. Surface danger zone for firing field artillery cannon or Expeditionary Fire Support System 120mm (rifled) mortar in the indirect mode at ground, fixed, or moving targets

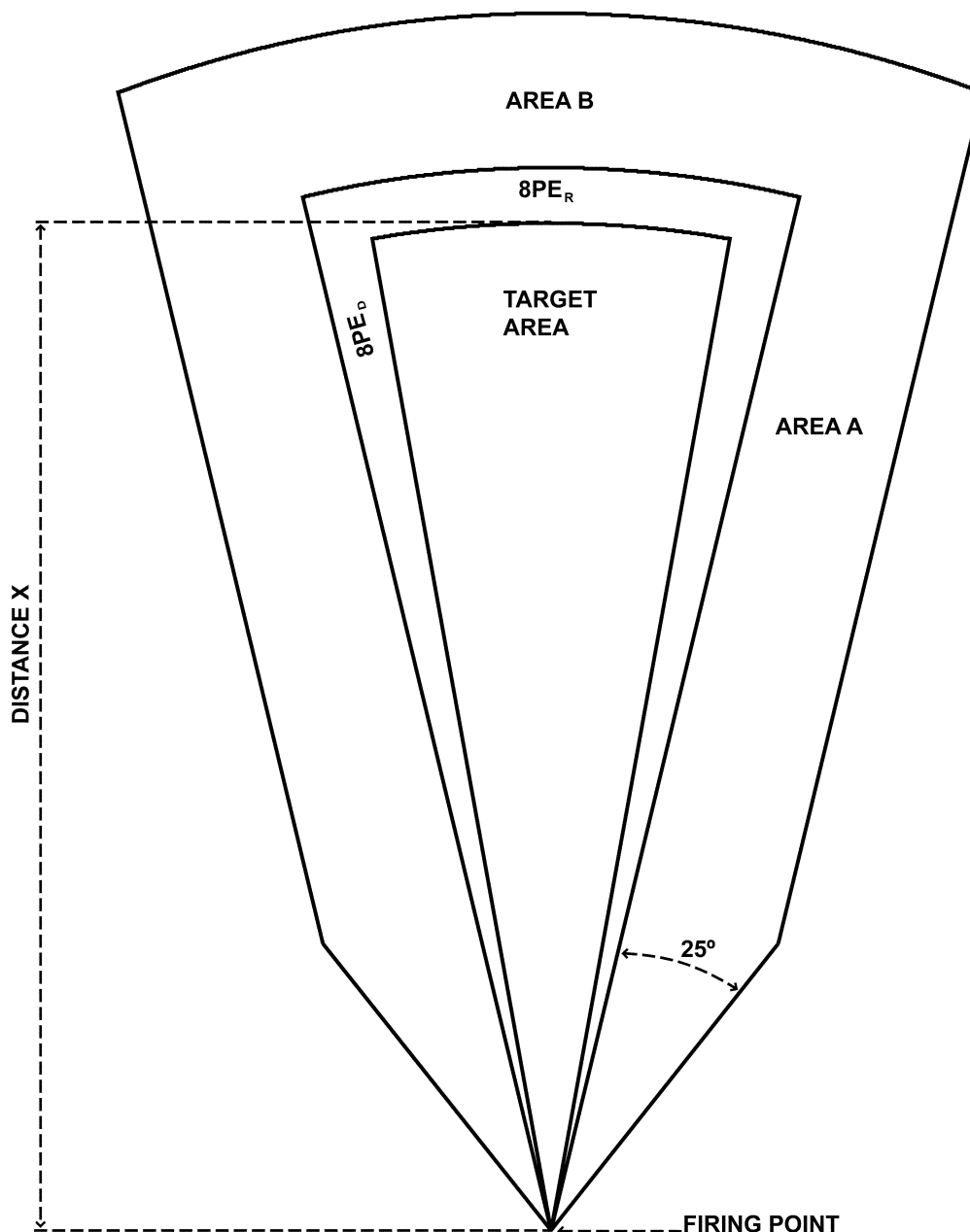

Figure 10-2. Surface danger zone for firing field artillery cannon in the direct mode at ground, fixed, or moving targets

10-8. Anti-personnel ammunition (Army)

a. Firing conditions.

(1) APERS ammunition is available for 105mm cannon artillery. It is designed for use against personnel in direct fire, muzzle action, or direct fire missions with a time setting.

(2) APERS ammunition will not be fired over the heads of unprotected personnel. Hardware discarded by functioning of APERS projectiles presents a potential hazard to personnel to the side and rear of the weapon.

b. Surface danger zone.

(1) SDZ requirements for APERS ammunition is given in table 10-5 and figure 10-3.

(2) Distance X is based on the range at 15 degrees QE.

(3) For other than muzzle action functioning, begin APERS SDZ construction downrange at a distance equal to the time of fuze setting.

Table 10–5
Anti-personnel ammunition surface danger zone criteria

Caliber	Distance X (m)	Distance D (m)
105mm howitzer M102, M119, M546	7,900	1,100

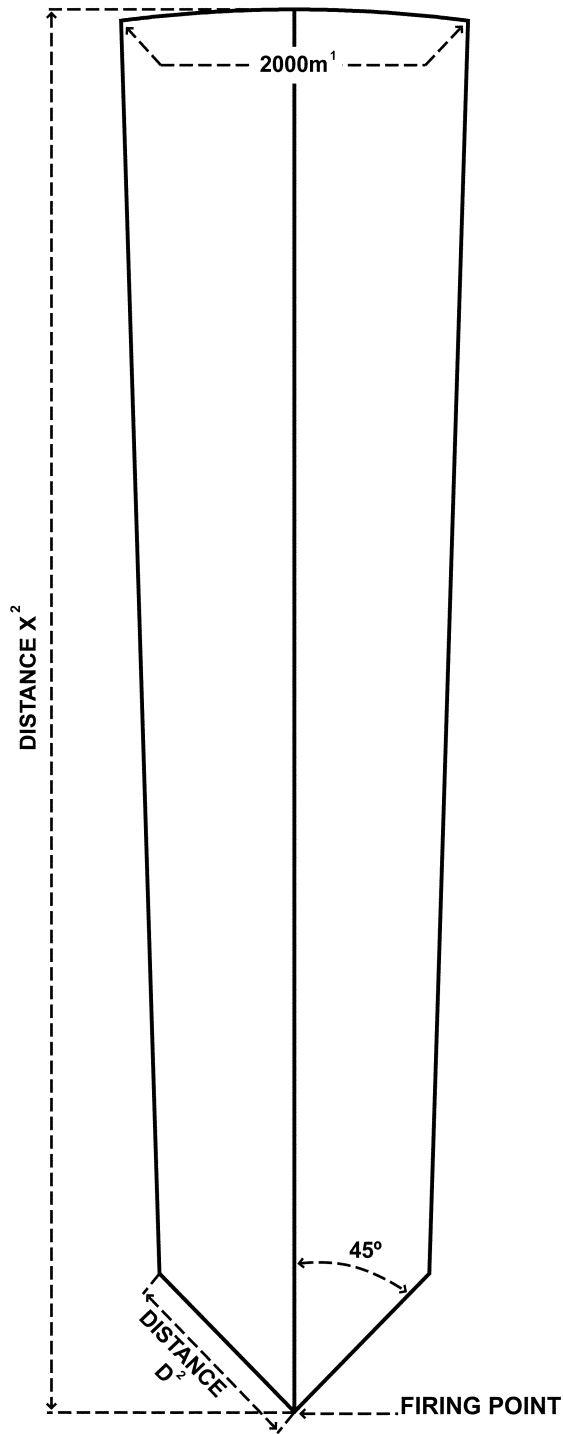

Notes:

¹ WARNING: Hardware discarded by the functioning of the projectile presents a potential hazard to unprotected personnel located to the side and rear of the weapon.

² Distance is 2,000 m or 1.41D, whichever is greater.

³ For Distance X and Distance D, see table 10–5.

Figure 10–3. Surface danger zone for firing field artillery cannon with antipersonnel ammunition in the direct mode at fixed or moving targets¹

10-9. M712 Copperhead cannon-launched guided projectile (Army)

a. Firing conditions.

- (1) FIST personnel located in the mission-essential area (MEA) will wear approved IBA and protective helmets.
- (2) FIST personnel are not authorized to occupy the SDZ when a Copperhead is fired in the ballistic mode.
- (3) Laser designators used with the Copperhead will be operated in accordance with the safety guidelines in chapter 16 of this pamphlet.
- (4) Specific safety procedures and firing computations for Copperhead projectiles are found in FM 6-40.

b. Surface danger zone.

- (1) Special SDZ construction requirements for Copperhead projectiles are given in figures 10-4 and 10-5.
- (2) The MEA must start at least 1.5 km in front of the target and not exceed 3.5 km in length (distance equals a total of 5 km from the target). The MEA must remain outside of the prohibited area of the SDZ.

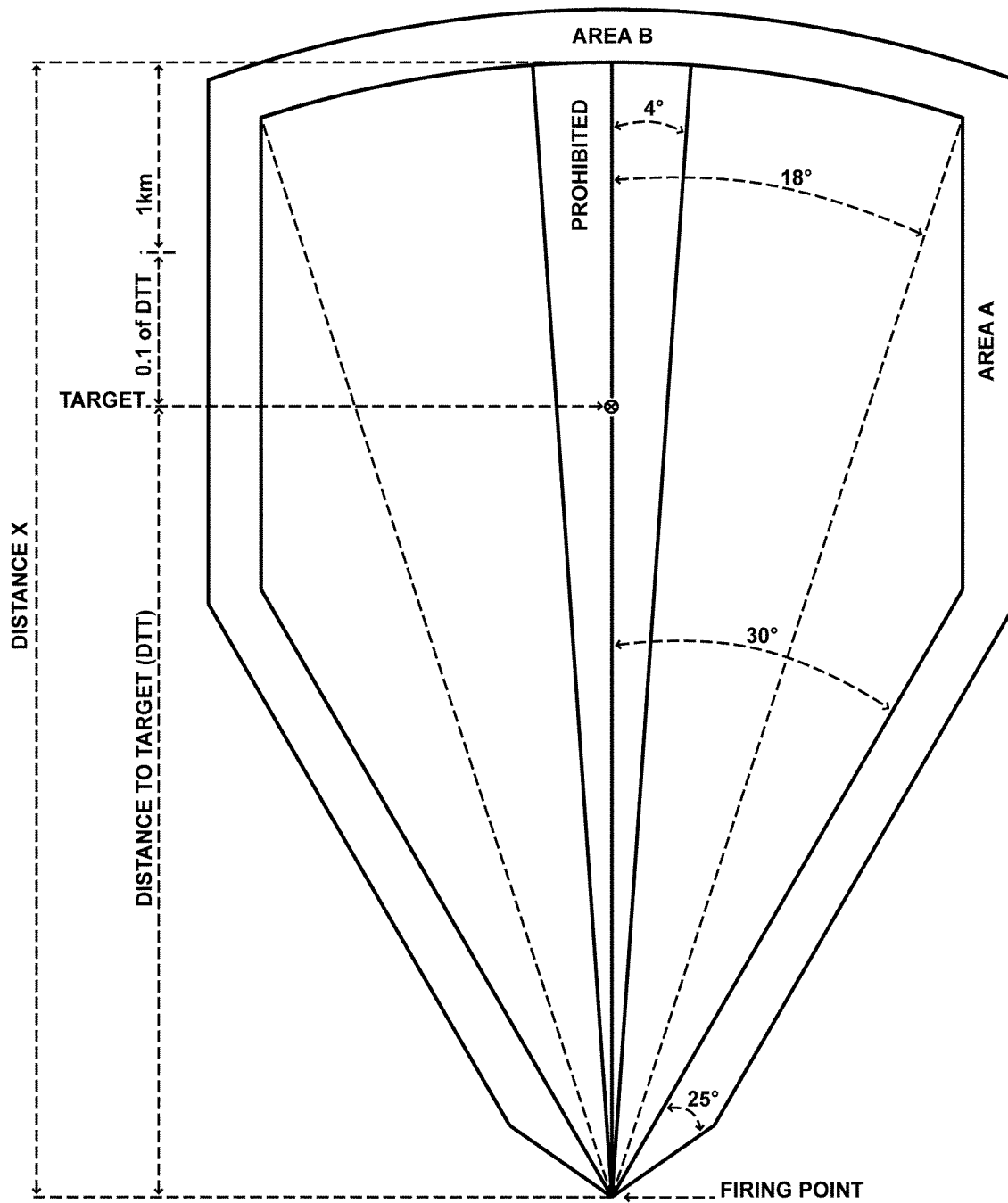

Figure 10-4. Surface danger zone for firing Copperhead projectiles in the ballistic mode

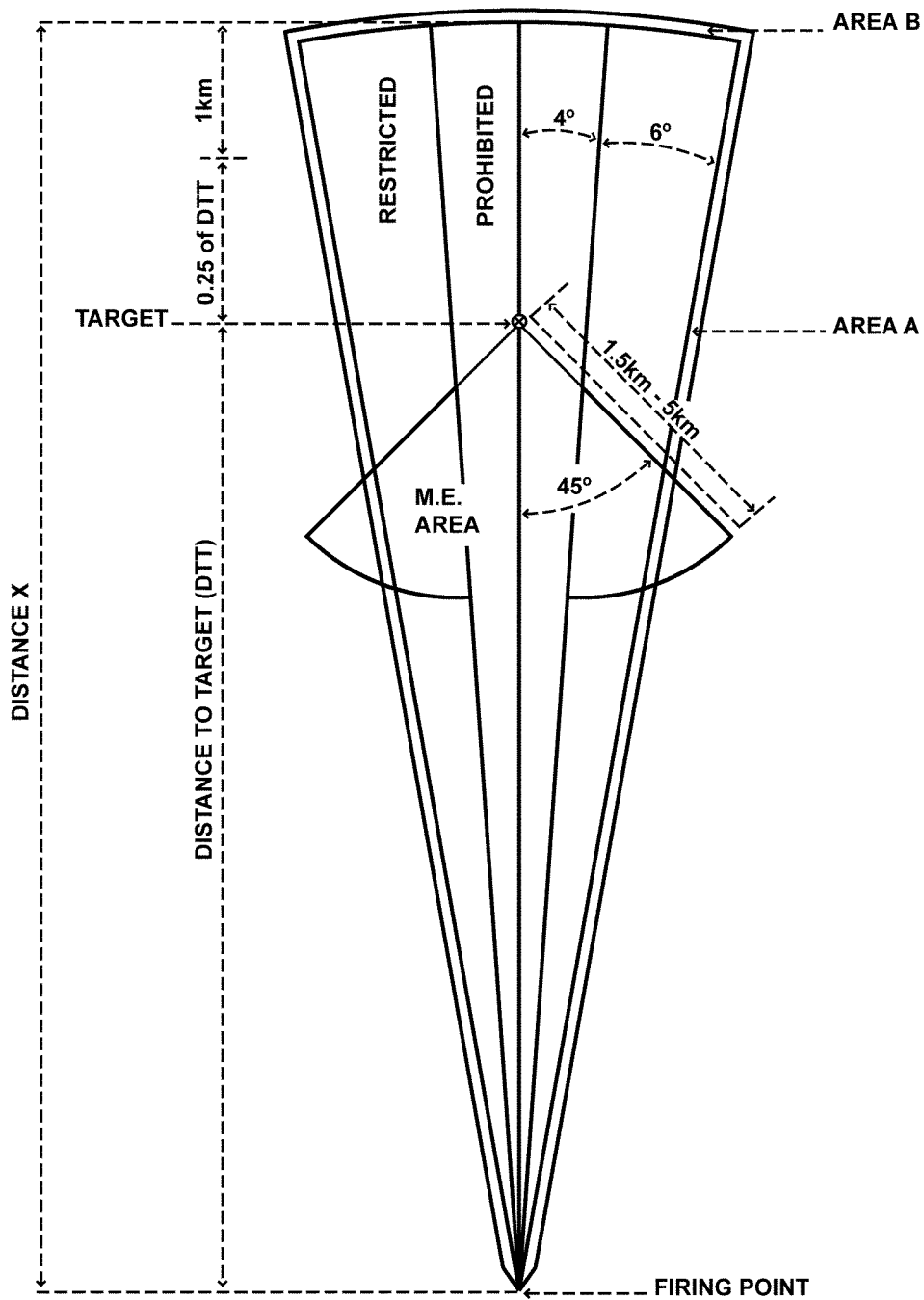

Figure 10-5. Surface danger zone for firing Copperhead projectiles in the glide mode

10-10. Flight corridors (refer to chapter 11 for aviation range safety)

Flight corridors are created to vertically and laterally separate aircraft from surface fires. Aircraft may operate within or pass through artillery cannon danger zones, provided —

a. They are established where the maximum altitude of the aircraft will be below the ordinate corresponding to the minimum QE of the ammunition being fired above the flight corridor and corrected for density altitude. Flight corridors may provide access only through Area D. (See figs 10-1 and 10-6.) Altitudes in flight corridors will be indicated in MSL.

b. Permanent aircraft flight corridors are established under firing corridors. Corridors will be through Area D and

outside Areas C and E. Altitude restrictions will be in accordance with paragraph *a*, above. Corridors will follow easily identifiable markers and routes. Flight control points will be established and aircrews briefed on flight navigation procedures. Maps of flight corridors (fig 10–7) will be made available at installation range operations (Army), range control (Marine Corps), facilities base operations, and other locations deemed appropriate by the installation RMA (Army), RCO (Marine Corps).

c. Communications will be maintained among the designated aircraft, range operations firing desk (Army), range control (Marine Corps), and the firing unit on a common communications network. Aircraft will report entry and exit of specific vertical danger zones. This is not applicable to aircraft operating as part of tactical exercises with firing elements provided communication is maintained between participants. A communications failure with aircraft in a flight corridor requires an immediate cease-fire. These procedures will be established by local SOP.

d. Aircraft operating within SDZs as part of an exercise will remain a minimum of 500 m from GTLs and outside of Areas C and E.

e. Only ammunition certified for overhead fire will be used when aircraft are operating in or passing over SDZs.

f. Uncontrolled flights within SDZs are not authorized.

g. Computing the stay above (SA) and stay below (SB) distances (for feet AGL) you must —

(1) Determine the GTL and the firing unit range to target.

(2) Determine the munitions type and charge being fired.

(3) Determine the vertical interval (VI) (VI=target altitude - firing unit altitude in meters).

(4) Determine where the final attack heading (FAH) or cone crosses the GTL and the gun target range at those points.

(5) Refer to the appropriate trajectory chart by munitions/charge and determine the arc corresponding to range to target.

(6) Determine the altitude (in meters) corresponding to the ranges where the final attack cone crosses the GTL by tracing the arc to those ranges.

(*a*) Highest altitude + VI=ALT 1. Multiply by 3.3 to convert to feet. (Note: if the final attack cone straddles the summit of the trajectory, use the Max Ord for ALT 1).

(*b*) Lowest altitude + VI=ALT 1. Multiply by 3.3 to convert to feet.

(7) Incorporate a 1000 foot buffer for all nonstandard conditions.

(*a*) ALT 1 + 1,000 ft=SA (expressed to the next highest 100 ft AGL).

(*b*) ALT 1 - 1,000 ft=SB (expressed safe to the next lowest 100 ft AGL).

h. Computing the SA and SB distances (for feet MSL) you must—

(1) Determine the range to target in meters.

(2) Determine the projectile and charge trajectory.

(3) Determine target altitude in meters.

(4) Plot final attack heading from intersecting point 1 (IP 1) to intersecting point 2 (IP 2) in degrees magnetic.

(5) Determine where FAH intersects GTL at (IP 1) and (IP 2).

(6) Determine chart ordinate in meters at (IP 1) and (IP 2).

(7) Add target altitude to (IP 1) and (IP 2).

(8) Convert to feet (IP1) X 3.3 and (IP2) X 3.3.

(9) Add 1,000 ft to (IP 1) and subtract 1,000 ft from (IP 2).

i. When computing stay above or stay below the general rule is that if the FAH straddles the Max Ord, compute SA and SB against the Max Ord + or - 1000 ft.

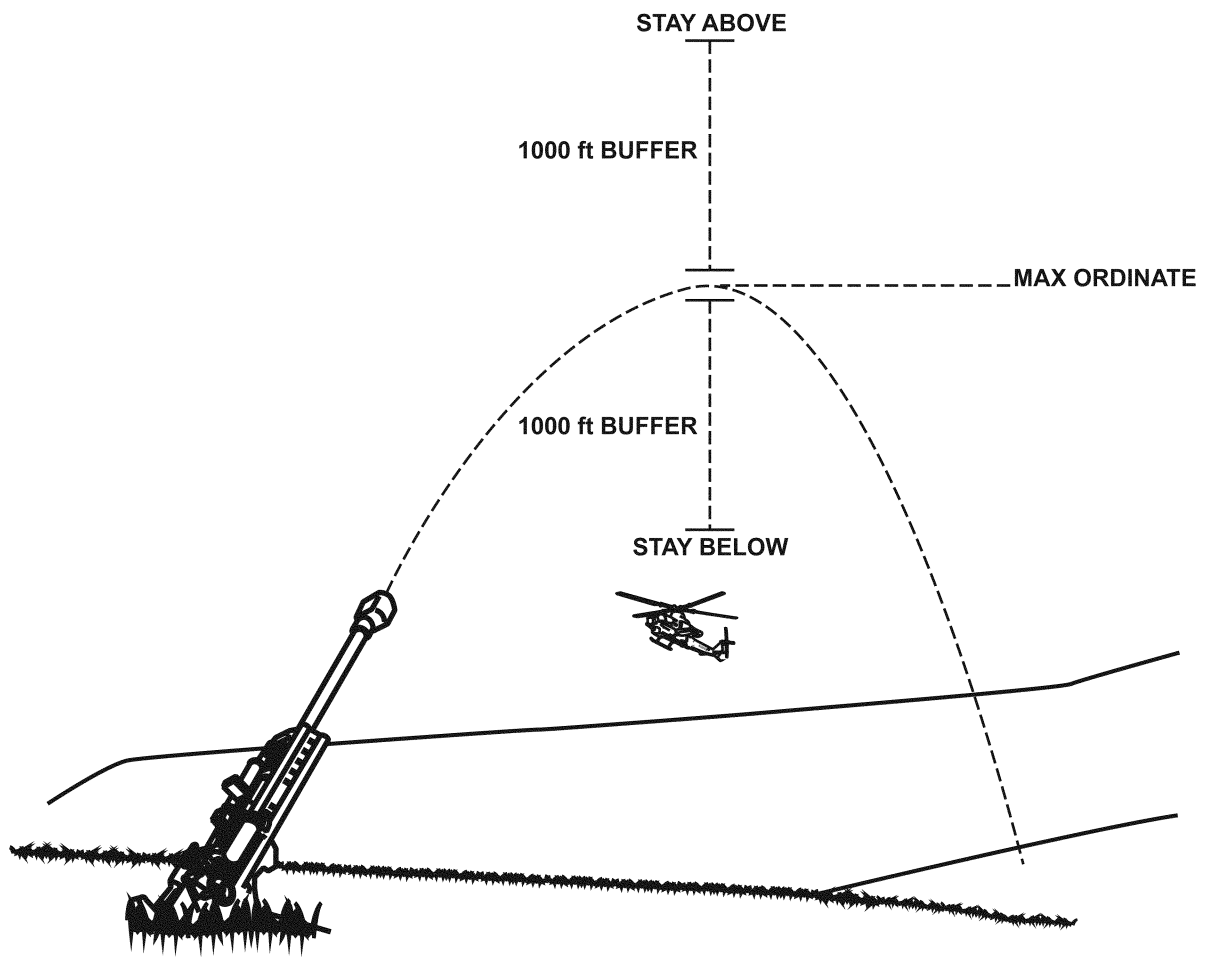

Figure 10-6. Flight corridor for field artillery cannon fire over aircraft

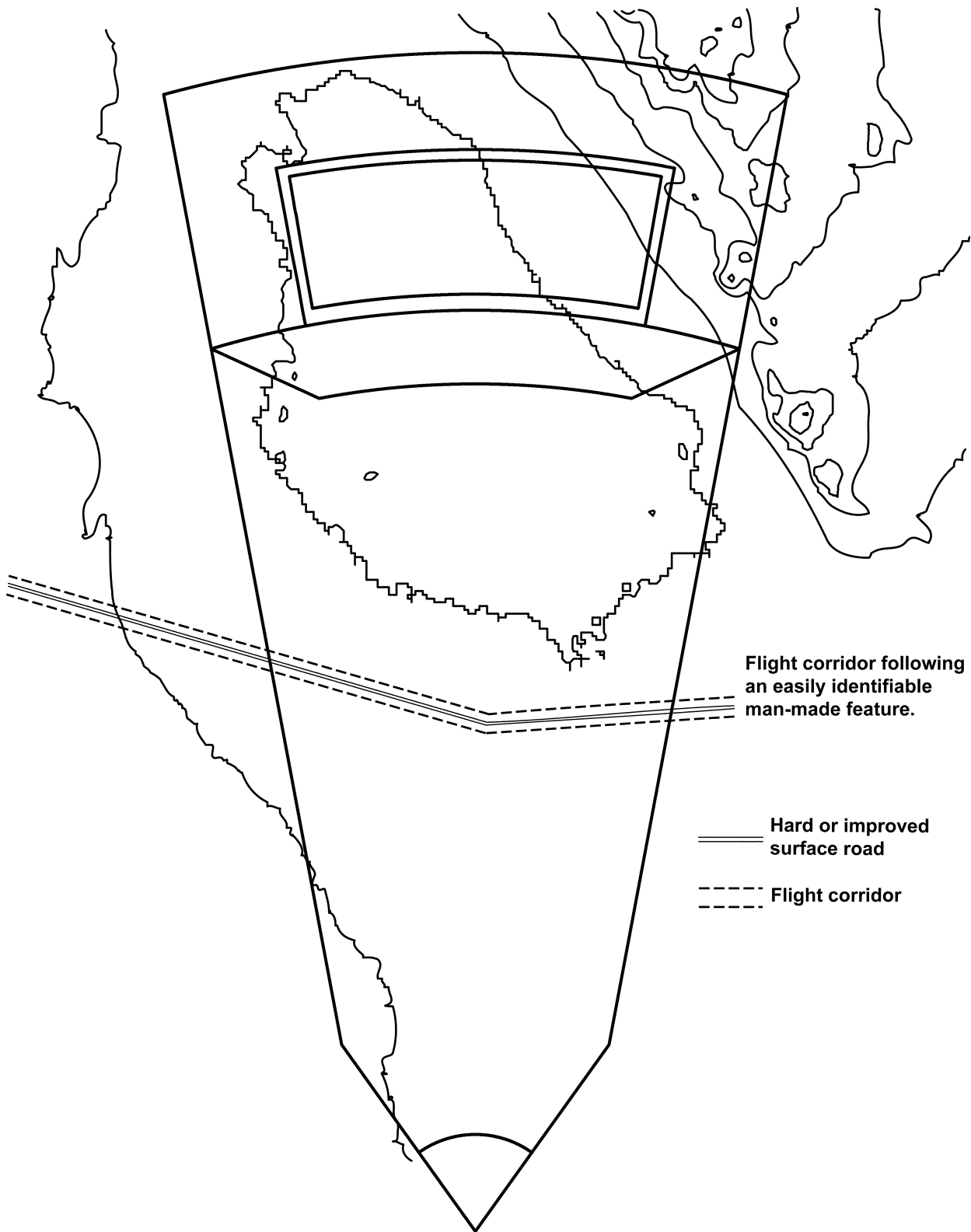

Figure 10-7. An example of an established flight corridor

10–11. Improved conventional munitions

a. Firing conditions.

(1) The firing of live ICM projectiles and dropping of aircraft-delivered live sub-munitions on Army ranges in training are currently prohibited.

(2) For the Marine Corps, the firing of dual-purpose improved conventional munitions is authorized in accordance with MCO P8011.4 and current MCBul 8011. Local range SOPs will dictate the specific conditions under which dual-purpose improved conventional munitions may be employed in training.

(3) ICM projectiles will not be fired over the heads of troops in training exercises.

(4) When ICM carriers fail to function and impact on hard surfaces, up range and lateral ricochets of up to 500 m may occur.

b. Surface danger zone.

(1) Requirements for field artillery cannon fired ICM are given in figures 10–1. Conventional ballistic tabular firing table data for the particular caliber projectile and weapon system combination will be used to determine maximum range when firing ICM projectiles. (See table 10–6).

(2) The impact area should be relatively flat and free from heavy vegetation.

(3) Danger Areas A and B will be observed for all firings of ICM projectiles. The data necessary to determine each of these are in table 10–7.

(4) The special design of ICM projectiles subjects them to the effects of wind velocity more than standard conventional projectiles. Sub-missile drift factors listed in table 10–8 may be added to or subtracted from the basic trajectory distances presented in respective ballistic tabular firing tables. For example, if the wind is blowing at 50 knots from the gun position toward the target and the gun is being fired at 600 mil (33.75 degrees), the maximum range from the firing table will be increased by 150 m. If the wind is coming perpendicular (left to right) to the GTL, the right deflection will be increased 160 m and the left deflection will be decreased 160 m.

Table 10–6
Maximum range data sources for improved conventional munitions

Model Number	Reference
M444	Standard 105mm Firing Tables for M1
M449	Standard 155mm Firing Tables for M107 w/FT–155–ADD–I–2
M483	Firing Tables FT 155–AN–2 w/C–1

Table 10–7
Secondary danger zones (A, B, and C) for improved conventional munitions

Cartridge	Areas A, B, and C ¹ (m)
M444	440
M449	480
M404	485
M483, M915	650

Notes:

¹ Values for Areas A, B, and C include a maximum wind sub-missile drift of 250 m in a 50 knot wind.

Table 10–8
Sub-missile drift factors for improved conventional munitions

Wind velocity (knots)	Elevation (mils)	Maximum range drift (m)	Maximum deflection (m)
50	300	250	250
50	600	150	160
50	1,150	100	100
10	300	50	50
10	600	40	30
10	1,150	20	20

10–12. Multiple Launch Rocket System and High Mobility Artillery Rocket System

a. Firing conditions.

- (1) All non-mission-essential personnel will be cleared from the SDZ.
- (2) Meteorological data in use at the fire control system will not be more than 4 hours old.
- (3) The weapon system navigation unit must be verified as correct. Ensure that the launcher is properly calibrated (M270 only), updated with a verified survey control point (if not using global positioning system navigation, and that startup data is correct.
- (4) Fire control system internal tests must be successfully completed.
- (5) Firings will not be conducted if:
 - (a) There is any question of proper operation of the launcher.
 - (b) The winds have changed dramatically since meteorological data was taken.
 - (c) Any other sign of abnormal operation is evident.
- (6) Safe separation distance between Multiple Launch Rocket System (MLRS) and High Mobility Artillery Rocket System (HIMARS) launchers firing simultaneously is 55 m.

b. Surface danger zone.

- (1) MLRS/HIMARS safety computations are contained in ATP 3–09.60 and MCRP 3–1.6.24. Values for Distance W and Distance X in ATP 3–09.60 and MCRP 3–1.6.24 have danger Areas A and B included in their values.
- (2) MLRS/HIMARS SDZ requirements for practice and tactical (for combat only with M77 grenade payload) warheads are provided in table 10–9 and figures 10–8, 10–9, 10–10, 10–11, 10–12, and 10–13. Dimensions of the SDZ vary according to range to target and launcher height above MSL. The SDZ consists of an impact area, Areas A, B, and F and exclusion Areas I, II, and III forming a rectangle around the target with a corresponding flight corridor back toward the launcher.
- (3) The rectangular impact area extends X meters beyond the target, Distance W to the left and right of the target, and 2,200 m from the target toward the launcher (Distance Y). The construction of the SDZ is completed by connecting the near left and right corners of the rectangle to respective points 350 m to the left and right of the launcher. The impact area is designed to contain fragments and debris (payload, warhead skin, and rocket motor) from normal functioning rockets. Distance X is adequate to contain rockets when the fuze fails to function.
- (4) Area A is 320 m.
- (5) Area B is 1,300 m.
- (6) Exclusion Area I is the 4,700 m area that extends forward of the launcher. It is endangered by premature fuze function or failure of the rocket motor during boost phase. Exclusion Area I may be reduced to not less than 1,000 m by deviation.
- (7) Exclusion Area III is an area 1,800 m on the up-range side of the impact area and parallel to Area B. This area is designed to contain fragments and debris from early functioning warheads at the near edge of the impact area.
- (8) Exclusion Area II is the remaining area located between Exclusion Areas I and III once these areas are constructed. Occupation of Exclusion Area II by unprotected personnel is authorized only under an approved deviation. Length of Exclusion Area II varies with range to target.
- (9) Area F is the area immediately to the rear of the launcher directly exposed to blast overpressure, fragments, and debris from rocket launch. Area F consists of two parts, the launcher danger area (LDA) and the noise hazard area (NHA). The LDA extends 350 m to each side of the launcher and 400 m to the rear. Personnel are not authorized to occupy the LDA during firing. The NHA extends an additional 300 m to 500 m past the LDA and may only be occupied by participating personnel wearing approved hearing protection.
- (10) Fin release failure impact area is required only for tactical rockets. This area is a sector with an origin at the launcher with a radius of 12,500 m. It includes a total angular measurement of 114 degrees centered about the azimuth of fire.

Table 10–9
Multiple Launch Rocket System/High Mobility Artillery Rocket System surface danger zone criteria

Range to target (m)	Distance X ¹ (m)	Distance W (m)
Min to 11,500	See note 2	840
11,501 to 15,000	5,000+H ¹	1,000
15,001 to 20,000	3,700+H ¹	1,300
20,001 to 23000	1,900+H ¹	1,500
23,001 to 27,000	2,300+H ¹	1,900
27,001 to Max	2,700+H ¹	2,900

Notes:

¹ H is the height of launcher above MSL in meters.

² For targets less than 11,500 m from the launcher, Distance X shall vary so that the distance from the launcher to the far edge of the impact area shall be 16,700 + H meters. Adding Area B results in a minimum required distance of 18,000 + H for short shots.

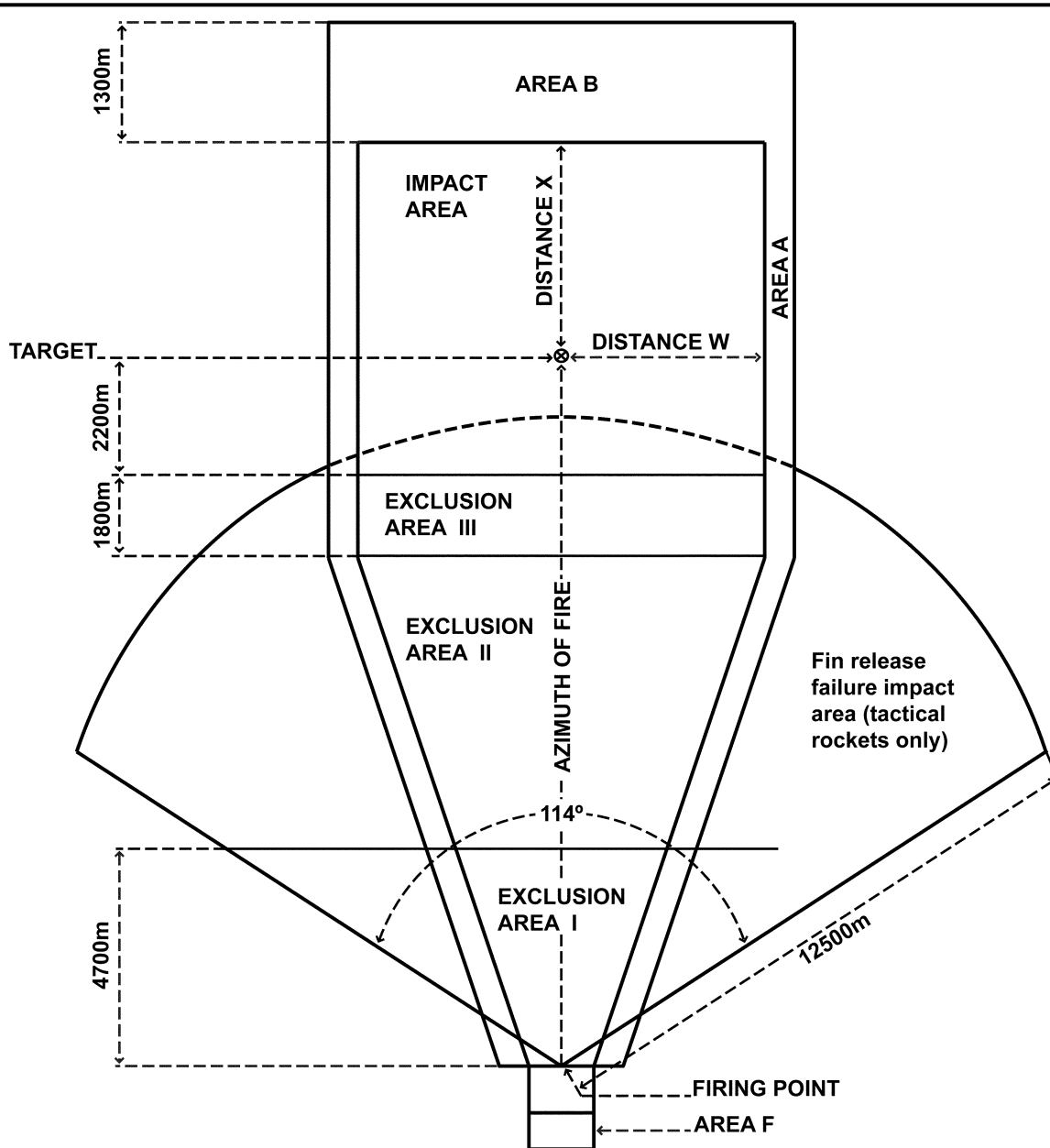

Notes:

¹ Area F dimensions shown in figure 10-9

Figure 10-8. Surface danger zone for firing Multiple Launch Rocket System/High Mobility Artillery Rocket System

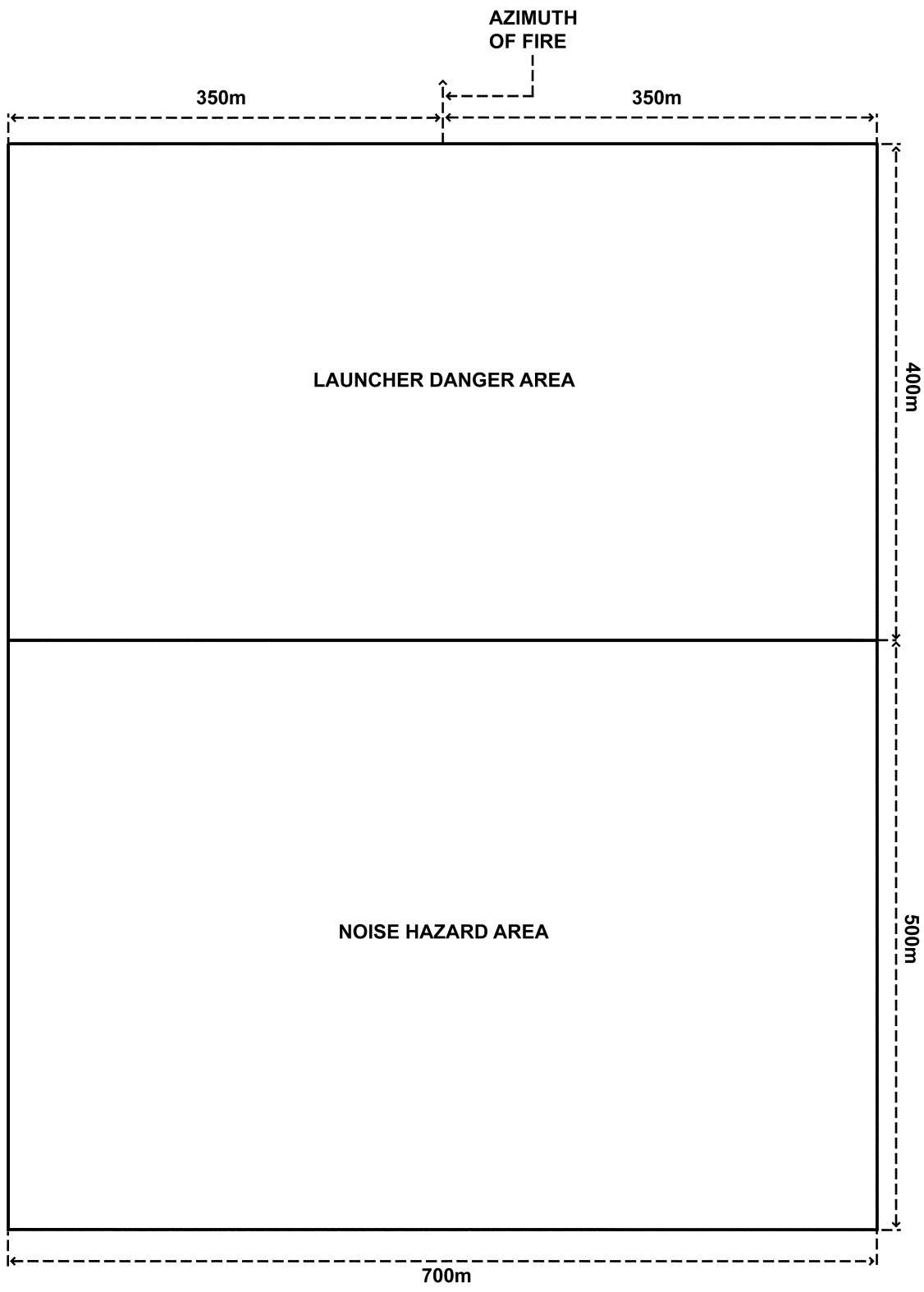

Figure 10-9. Area F for Multiple Launch Rocket System/High Mobility Artillery Rocket System

10–13. Multiple Launch Rocket System/High Mobility Artillery Rocket System reduced range practice rocket

a. Firing conditions for Multiple Launch Rocket System/High Mobility Artillery Rocket System reduced range practice rocket. These are the same as for standard MLRS and HIMARS (see para 10–12a).

b. Surface danger zone.

(1) MLRS/HIMARS reduced range practice rocket (RRPR) SDZ requirements are given in table 10–10 and figures 10–10, 10–11, 10–12, 10–13, and 10–14.

(2) The SDZ consists of an impact area, a target area or target point, a safety fan (for firing point to point and operational area (OPAREA) SDZs only), flight corridors, Exclusion Areas I and II, and Area F.

(3) The SDZ impact area is the rectangular area that will contain all but one in one million normally functioning rockets and debris. It is perpendicular to and bisected by the azimuth of fire.

(4) Distances W, X, and Y are buffer distances accounting for debris distribution. Applied inward to determine target areas or outward from a single point, these buffers ensure that less than one in one million normally functioning rockets impact outside prescribed safety limits. With regard to the azimuth of fire, Distance X is beyond the target, Distance Y is short of the target, and Distance W is to the flanks of the target.

(5) For the point-to-point method, the target box is determined by applying the values found in table 10–10, up range, down range, and laterally from the target location.

(6) The safety fan is defined by range and lateral limits within the target area.

(7) The flight corridors are areas parallel to the limits of the safety fan that extend from the forward corners of Area F to the far edge of the SDZ impact area.

(8) Exclusion Area I is the danger area directly in front of the firing point or OPAREA. This area extends 2,500 m toward the impact area (1:10,000 probability of injury). Based on risk estimates, Exclusion Area I may be reduced, by deviation, to not less than 1,000 m (1:1,000 probability of injury) (see fig 10–12).

(9) Exclusion Area II is the danger area between the forward limit of Exclusion Area I and the SDZ impact area. Exclusion Area II may be occupied by deviation only, per the criteria for overhead fire described in paragraph 10–12c.

(10) Area F is the area immediately to the rear of the launcher or OPAREA. Personnel may be exposed to blast overpressure, fragments, and debris from rocket launch. Area F extends 350 m to each side of the launcher and 400 m to the rear for point to point or firing point safety methods. It extends 400 m to each side of the OPAREA and 40 m to the rear of the OPAREA for OPAREA firing method. Personnel are not authorized to occupy Area F during firing. The NHA extends an additional 300 m past Area F and may only be occupied by mission-essential personnel wearing approved hearing protection.

(11) The target selection box (firing point and OPAREA SDZ only) is the set of all points from which a unit may select targets that will generate safe data regardless of where the launcher is within the OPAREA.

c. Overhead fire.

(1) The RRPR contains the same rocket motor failure potential as the basic rocket. However, because the RRPR does not have an explosive warhead event, the risk of firing over the heads of personnel authorized to occupy the SDZ is less than with the basic practice rocket.

(2) To calculate the risk of injury to personnel during overhead fire of RRPR under deviation, use a short round probability of 1 per 10,000 (.0001) firing when a 2,500 m Exclusion Area I is used. If a 1,000 m Exclusion Area I is used, a short round probability of 1 per 1,000 firings should be used. This information should be used in conjunction with personnel density and areas occupied to calculate risk to personnel on a per-shot basis.

(3) An evaluation of the RRPR flight corridor is necessary to ensure accurate risk assessment and provide options for improved training and firing flexibility. Two options for assessing probability are as follows:

(a) If a 2,500 m Exclusion Area I in front of the launcher is used, a short round probability of 1 per 10,000 firings should be applied.

(b) If a 1,000 m Exclusion Area I in front of the launcher is used, a short round probability of 1 per 1,000 firings should be applied.

(4) For both options, the short round hazardous debris area to be used for ranges up to 12 km is 300 x 100 m; for ranges from 12.1 km to 15 km, use 100 x 50 m.

(5) The calculations in figure 10–15 are provided to assist in determining risk of RRPR overhead fire and should be chosen based on the training mission requirements.

(6) These calculations provide for the ability to estimate a reasonable probability of injury(ies) or vehicle damage. They are estimates and assume a certain level of randomness and uniformity. The probabilities are established so that, although grouping of troops could result in multiple injuries, this grouping would also realistically result in a lower overall probability of injury.

(7) MLRS/HIMARS safety computations are contained in ATP 3-09.60 and MCRP 3-1.6.24.

Table 10-10
Multiple Launch Rocket System/High Mobility Artillery Rocket System reduced range practice rocket surface danger zone criteria (M28A1/A2)

Range	Distance X (m)	Distance W (m)	Distance Y (m)	Target box dimensions ¹ (m)
8,000 to 9,000	2,525	770	1,905	218
9,001 to 10,000	2,155	855	1,635	240
10,001 to 11,000	1,795	945	1,440	264
11,001 to 12,000	1,485	1,045	1,290	288
12,001 to 13,000	1,220	1,155	1,185	312
13,001 to 14,000	1,175	1,290	1,115	336
14,001 to 15,000	1,275	1,475	1,075	360

Notes:

¹ Target box dimensions are applied to point-to-point method only.

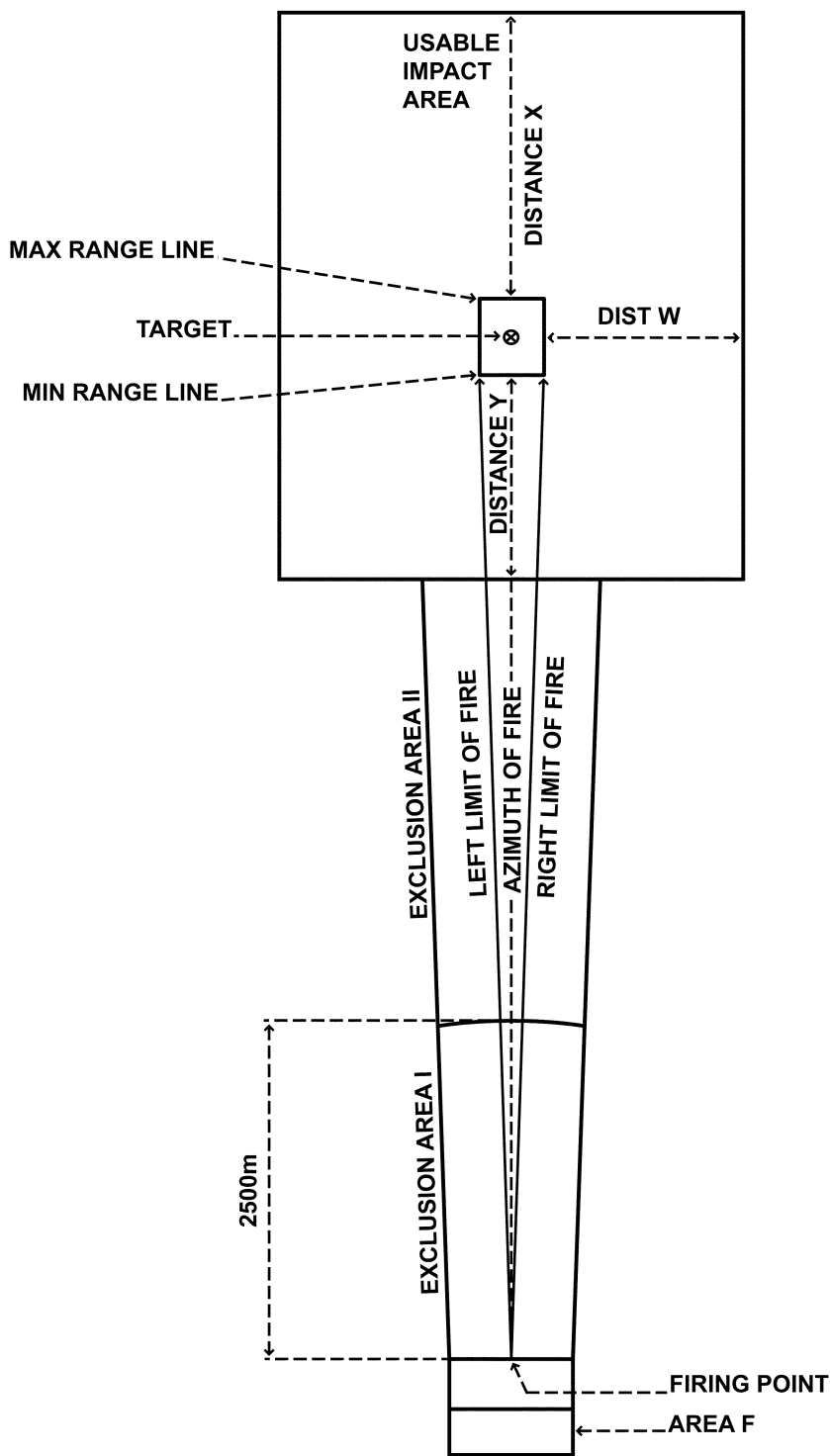

Notes:

¹ Area F dimensions shown in figure 10-13

Figure 10-10. Surface danger zone for firing Multiple Launch Rocket System/High Mobility Artillery Rocket Systems reduced range practice rocket point to point

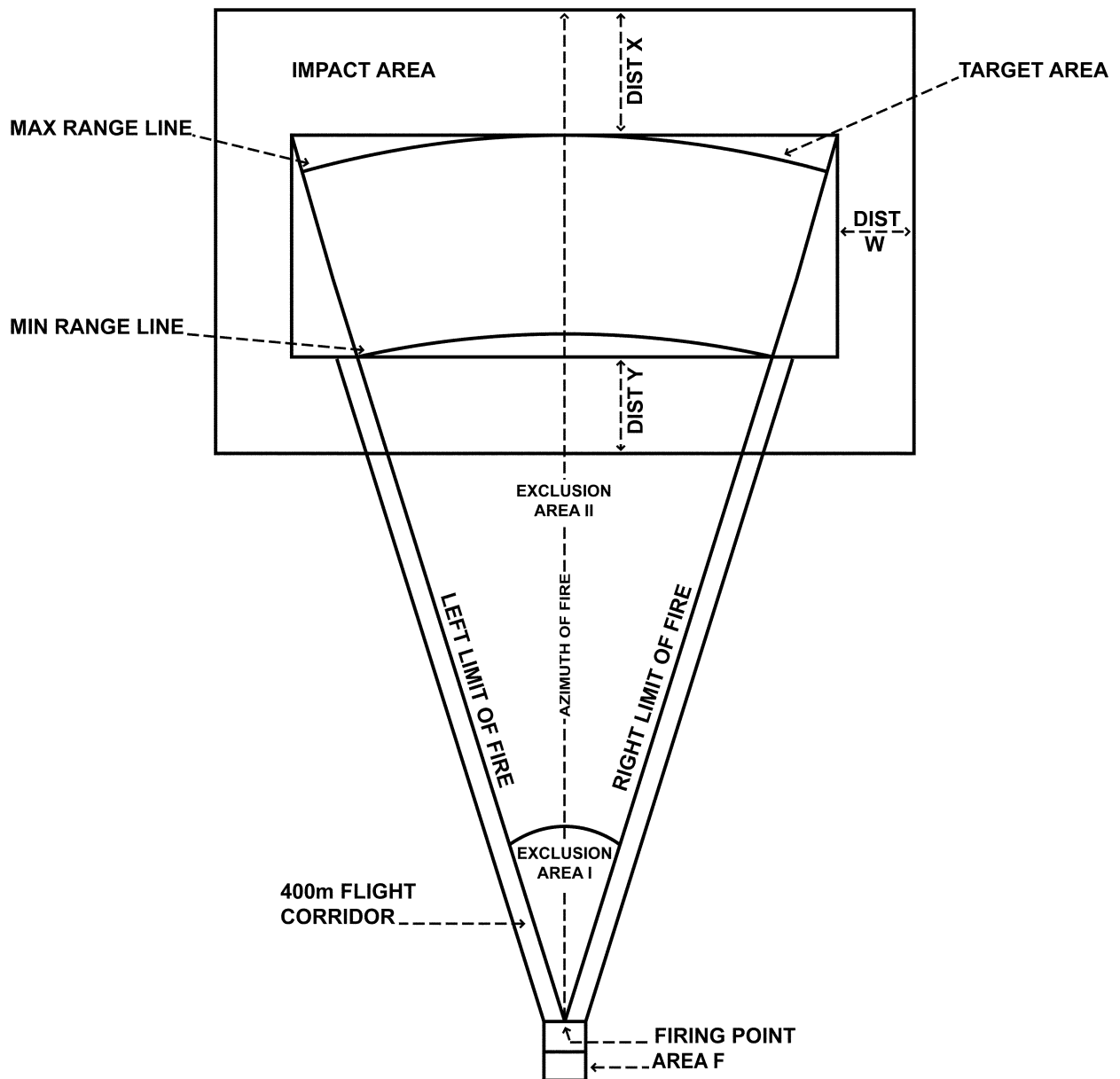

Notes:

¹ Area F dimensions shown in figure 10-13

Figure 10-11. Surface danger zone for firing Multiple Launch Rocket System/High Mobility Artillery Rocket Systems reduced range practice rocket point-to-area

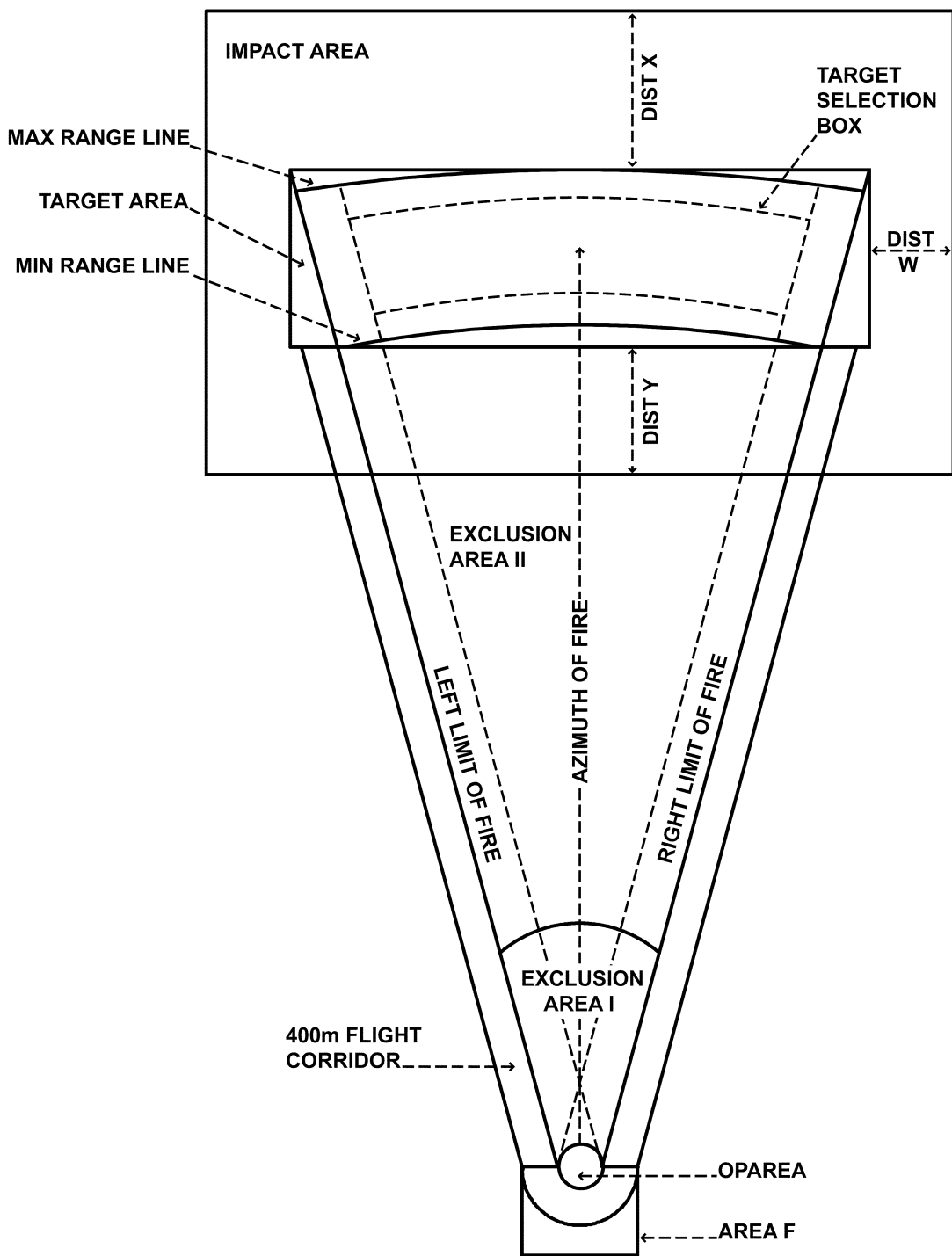

Notes:

¹ Area F dimensions shown in figure 10-13

Figure 10-12. Surface danger zone for firing Multiple Launch Rocket System/High Mobility Artillery Rocket Systems reduced range practice rocket operational area

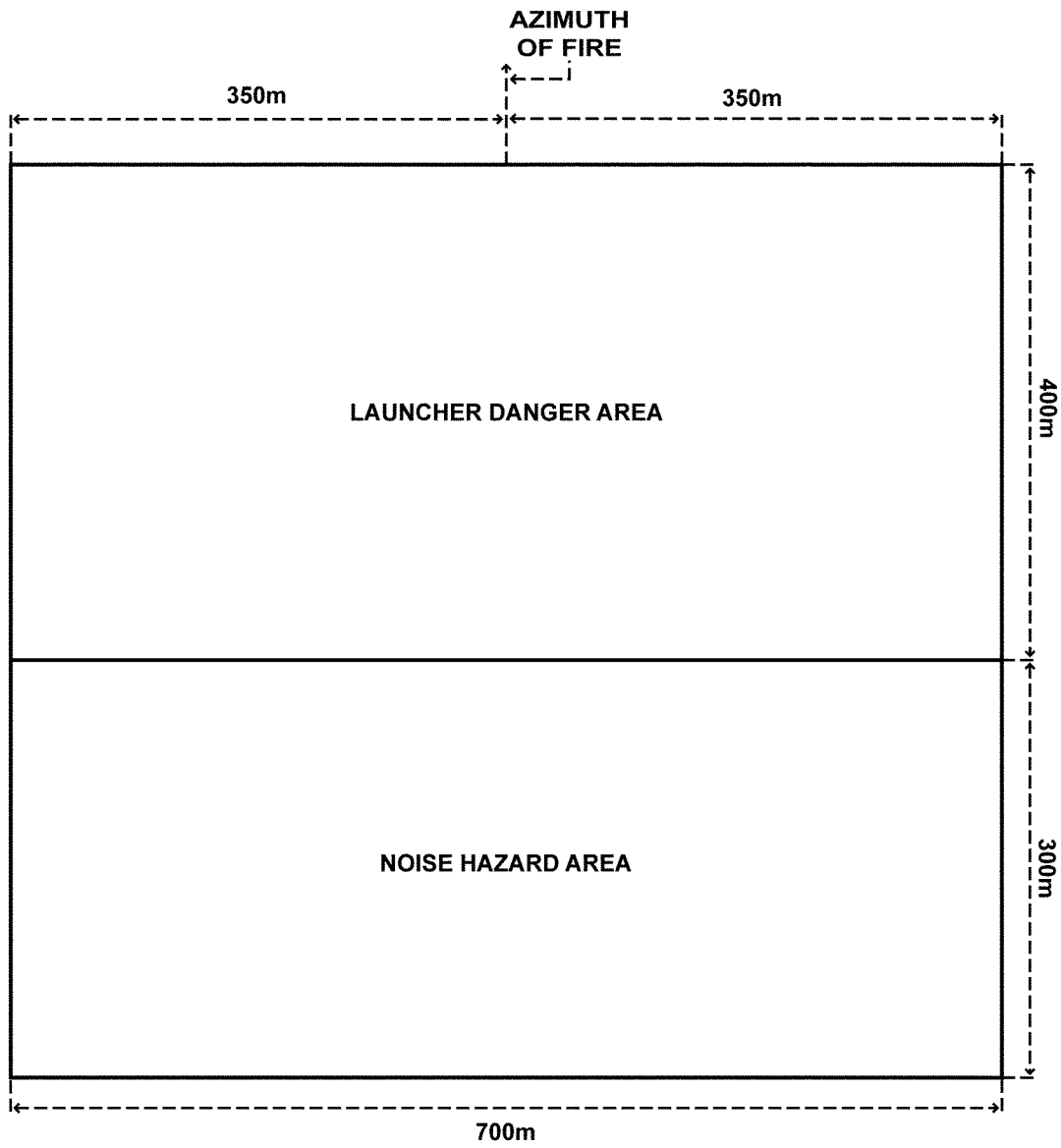

Figure 10-13. Area F for Multiple Launch Rocket System/High Mobility Artillery Rocket Systems reduced range practice rocket

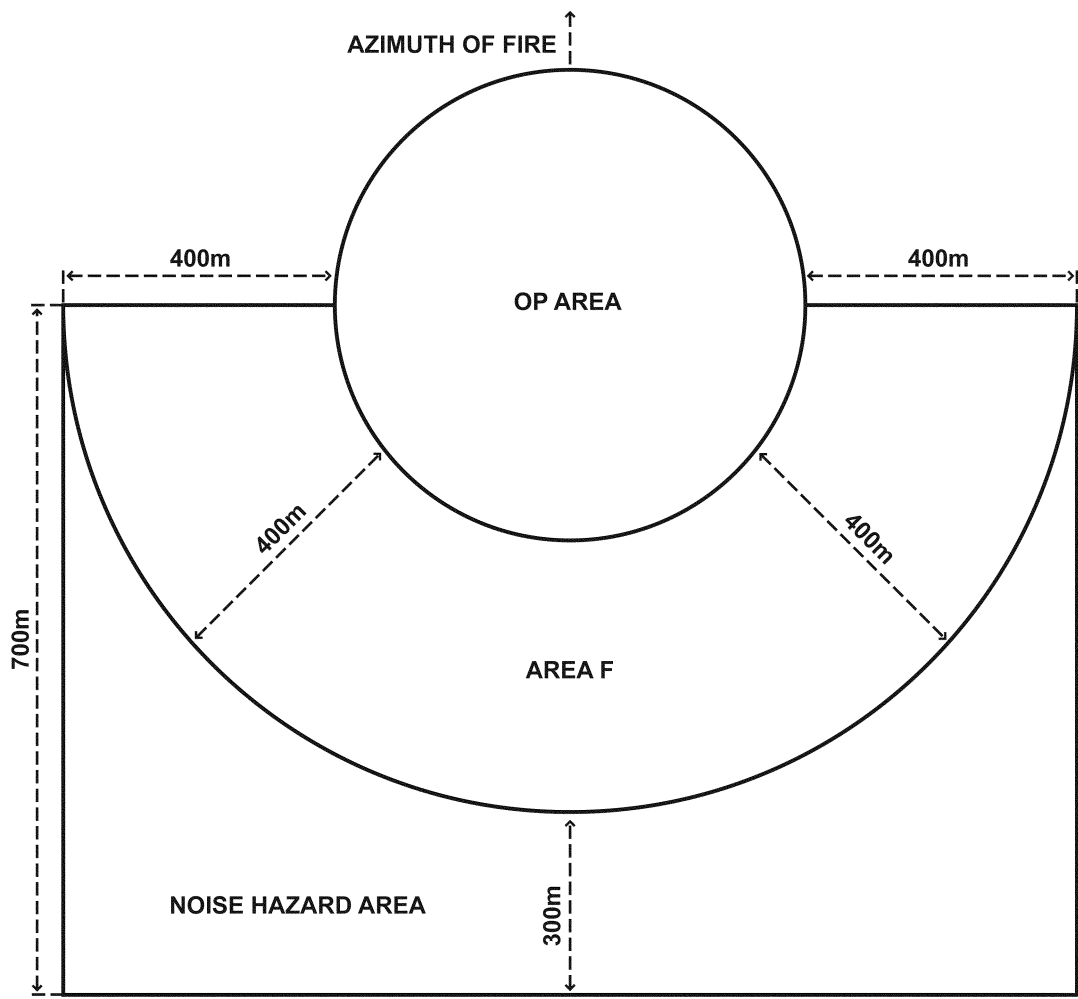

Figure 10-14. Area F for reduced range practice rocket operational area

Probability of injury(ies) = $ABC(E/D)$

Probability of injury(ies) = $AB(F/D)$

Probability of vehicle damage = $ABG(E/D)$

Probability of injury(ies)/vehicle damage(s) $AB(H/I)$

A = Probability of short round

B = Number of rockets fired

C = Number of personnel exposed

D = Size of occupiable corridor (based on target distance, in M^2)

E = Estimate of short round impact debris area (300m x 100m or 100m x 50m)

F = Area occupied by tank trail, road, site, etc. (when exact number of personnel/vehicles not known) in M^2 .

G = Number of vehicles exposed

H = (Length of short round impact debris ares) + (width of trail/road), in meters

I = Length of occupiable corridor, in meters.

Figure 10–15. Formulas for determining risk during Multiple Launch Rocket System/High Mobility Artillery Rocket System reduced range practice rocket overhead fire

Chapter 11 Aviation Range Safety

11–1. General

a. Aircrew requirements.

(1) All aircrew operating within a range/training airspace complex shall participate in a range safety brief and understand installation range regulations prior to operating within the complex.

(2) Aircrews shall take all measures necessary to ensure they conduct training within assigned SUA or other authorized operating areas and that all effects are contained within range complex boundaries.

b. Scheduling.

(1) All aviation operations conducted within a range/SUA shall be scheduled with the scheduling activity.

(2) SUA will be scheduled via the Range Facility Management Support System when available and designated/activated in accordance with paragraph 2–4 of this pamphlet for all air-to-ground operations.

c. Communications.

(1) Two-way communication will be maintained between the OIC and the installation range operations firing desk (Army), range control office (Marine Corps).

(2) Range operations firing desk (Army), range control (Marine Corps) must be able to maintain radio contact with all aircraft operating on the range. Communication relays are authorized as long as the RMA (Army), RCO (Marine Corps) has a method (for example, tunable radio) to contact aircraft immediately in the event of an imminent situation.

(3) All aircraft utilizing ranges shall monitor the guard frequency. Range management will have the capability to transmit/receive on the guard frequency (121.5 VHF/243.0 UHF).

d. Weather.

(1) All aviation training shall be conducted in visual meteorological conditions (VMC) unless otherwise approved by the OIC and coordinated with range operations (Army), range control (Marine Corps).

(2) The local weather detachment or command post must advise the OIC and or RMA (Army), RCO (Marine Corps) of any sudden adverse weather changes (watches, warnings, or advisories) that might impact range operations or safety.

(3) The OIC will monitor weather conditions (such as altimeter, wind direction/velocity, and ceiling) and provide general safety and weather updates during range operations as required.

e. Parachutes.

(1) The unit using the drop zone (DZ) is required to survey the DZ 24 hours prior to use.

(2) Parachute aircrew and DZ personnel shall maintain communications with the range operations firing desk (Army), range control (Marine Corps).

(3) DZs will be confirmed clear before commencement of parachute or parachute operations.

(4) Joint Precision Airdrop System (JPADS).

(a) The unit dropping the load is responsible for using JPADS mission planning software before they fly the mission.

(b) Range operations (Army), range control (Marine Corps) will approve Improved-Container Delivery System deliveries only if the Precision Airdrop System-Mission Planner derived point of impact, the 3-sigma footprint for chute failure, and the guidance failure footprint overlay on government owned, leased, or otherwise controlled land with no unauthorized personnel present and a collateral damage estimate acceptable to the RMA (Army), RCO (Marine Corps).

(c) Equipment, facilities and participating personnel are permitted within the 3-sigma success, chute failure, and the guidance failure footprints as long as range management has conducted and approved an operational risk assessment.

(d) RMAs (Army), RCOs (Marine Corps) should note that JPADS users may desire to update weather observations by dropping a sonde (foot long metal wind sensor) for wind updates in order to revise footprint analyses up until the time of delivery.

f. Countermeasures. The use of chaff/flares will comply with local range regulations/SOPs, FAA requirements, and in accordance with aircraft TMs.

11-2. Firing operations, general requirements

a. Weapon danger zones.

(1) Air-to-ground delivery of munitions can be accomplished from a variety of platforms to include fixed wing (FW), rotary wing (RW), and Unmanned Aircraft Systems (UASs). The hazardous zone associated with these munitions will now be generated through the use of the WDZ tool that can provide a WDZ for all aviation delivered ordnance. The WDZ is modeled to represent the distribution of impacts, ricochets/broaches, and the vertical hazard associated with fragmentation and the ricochet (see para 11-6).

(2) The three-dimensional aspect of munitions delivery can present many challenges when determining the safe location of personnel and facilities operating on the ground. RMTK advances in computer modeling, programming, software, and improved risk analysis provided by the WDZ tool enables RMAs (Army), RCOs (Marine Corps) to reduce risks to personnel and facilities involved with aviation operations.

(3) RMAs (Army), RCOs (Marine Corps) must employ safe management practices that provide the visibility and control required for the integration of both air and ground operations. The use of the WDZ tool supplemented with an aggressive risk mitigation program will help reduce the complications and dangers associated with this training.

b. Aircrew currency qualifications for aviation weapons delivery.

(1) Army.

(a) During firing, qualified standardization instructor pilots or instructor pilots having immediate access to positive control of the aircraft and weapon systems being fired will accompany pilots and gunners who are not current and qualified in the aircraft.

(b) Qualified nonrated crew member flight instructors or nonrated crew member unit trainers having immediate access to the weapons systems being fired will accompany door gunners who are not current and qualified.

(2) Marine Corps. Marine pilot and aerial gunners will demonstrate flight and weapons system proficiency in accordance with the appropriate TMs/Training and Readiness manuals.

c. Aircrew weapons qualifications for aviation weapons delivery.

(1) Pilots and gunners will successfully complete an approved qualification course or qualification or transition training in accordance with an approved program of instruction.

(2) Pilots and gunners will demonstrate flight and weapon systems proficiency in accordance with TC 3-04.11, FM 3-04.140, and the appropriate aircrew training manuals.

d. Communications.

(1) All firing elements must maintain positive two-way communications with the OIC.

(2) Firing will be suspended immediately upon loss of communications with the range operations firing desk (Army), range control (Marine Corps), the OIC, or firing elements.

(3) Command and control aircraft may be used at the commander's discretion.

e. Night operations.

(1) Night range operations present unique challenges to both the aircrew and the OIC. Visual cues are greatly reduced, even with the use of night vision devices (NVDs).

- (2) OICs should use NVDs during night operations and have access to a minimum of Generation III NVDs.

11–3. Firing conditions, general procedures

a. General.

- (1) Pilots and gunners will be familiar with the impact area, firing limits, and safety regulations for the range on which they will fire.

- (2) The firing aircraft pilot in command will ensure that firing aircraft are properly oriented with the target and are safe to fire.

- (3) For FW operations: If the OIC cannot positively determine that the aircraft can release safely, the OIC will delegate ordnance release clearance to a qualified flight lead, individual pilot, forward air controller or other briefed person. The OIC will maintain overall authority on the range for the training event and can abort the release or direct a ceasefire at anytime. In all cases the pilot assumes sole responsibility for the safe release of ordnance and confirmation of the approved target.

- (4) For UAS operations: The mission commander will maintain the responsibility for the safe operation of payload and platform.

- (5) All live-fire training must be observed.

b. Armament safety procedures.

- (1) Aircraft weapon systems will be loaded or unloaded only in approved areas. Selection of these areas will ensure total containment in the event of accidental discharge. The weapon systems dispersion angle and maximum range will be considered if natural or manmade barriers are not used.

- (2) Airspace routing used by RW aircraft flying from the ammunition loading site to and from the firing range will be plotted on a map or chart and maintained by both the using unit and the installation range operations office (Army), range control office (Marine Corps). This course will be selected so that accidental firing at any point on the course will minimize risk to life and property, however, aircraft weapon systems will be maintained in a safe condition until within the range boundary. RW aircraft routing from the ammunition loading site to the firing range will be published in local SOPs.

- (3) When training requirements dictate, commanders (battalion, squadron, or higher) will direct the loading and unloading of ammunition from aircraft while the engines are running. Such operations are authorized when a thorough risk assessment has been conducted, control measures implemented and residual risks identified and accepted by the appropriate commander.

- (4) A dry pass or range sweep for the entire range, focusing on the target area, will be accomplished to ensure personnel are clear from hazardous effects. Aircraft may use onboard sensors (advance targeting pods, sniper, lighting), or UAS targeting payload in lieu of a dry pass. Terminal controllers observing the target area may waive the dry pass.

- (5) Prior to first weapons release/firing for each pass, final switch configuration will not be accomplished until the aircraft is in such a position that accidental activation or release will be contained within the range, and not represent a danger to ground personnel.

- (6) Aircraft will be a minimum of one switch position (excluding trigger) away from weapons release/firing when not oriented toward the target area unless approved by range operations (Army), range control (Marine Corps). Switch manipulation shall not occur until after safe recovery of weapons delivery/firing. RW aircraft will be in a safe condition prior to departing an aerial firing point unless otherwise directed.

- (7) Prior to leaving a range area, FW aircraft will conduct a hung ordnance check. If hung ordnance remains on board the aircraft due to malfunction, loss of range time, and so forth, then ensure compliance with local restrictions to avoid undue risk for the return flight. For RW aircraft, the pilot in command shall ensure that all weapon systems are clear of ammunition prior to departing the range. Upon completion of training, aircraft weapon systems will be safed in accordance with aircraft TMs before leaving the range.

- (8) Crash rescue personnel will be knowledgeable of safety precautions associated with armed aircraft and impact areas and the hazards associated with burned aircraft (for example, radioactive and advanced composite materials).

c. Hung ordnance and jettison areas.

- (1) Range operations (Army), range control (Marine Corps) will ensure all aircraft report ordnance expended, hung ordnance, and UXO locations to the range operations firing desk (Army), range control (Marine Corps) prior to departing the range.

- (2) Installation SOPs and range directives will designate ordnance jettison and emergency landing areas for use by aircraft experiencing weapons malfunctions or in-flight emergencies.

- (3) Jettison areas will be located such that maximum protection is provided to personnel and range facilities in case the jettisoned ordnance detonates.

- (4) Fuel spill materials (spill kits) will be available at forward arming and refueling points. Fuel tankers used to refuel aircraft will be equipped with sufficient absorbent material to handle small to moderate spills.

- (5) Commanders will develop and implement an aggressive program to ensure crew coordination and combat identification procedures concurrent with the gunnery training program. For the Army, combat identification training

will be conducted in accordance with TC 25–8, TC 3–04.11, TC 3–04.35, FM 3–04.140, and appropriate air crew training manuals.

11–4. Firing conditions, specific requirements

a. Running fire. When conducting running fires, cockpit displayed graphics, ground markers, or prominent terrain will be used to mark start and cease fire lines.

b. Hover fire. When conducting hover fire, the firing position will be marked. If possible, hover fire should be conducted over level terrain free of flight hazards (for example, dust, brush, trees, blowing debris). Natural or manmade features will be used to aid in the establishment of range boundaries and control measures.

c. Markers. When used, markers will be illuminated and/or thermalized when thermal weapons sights are used to ensure proper target area identification at times of limited visibility when required. Additional ground markings will be used at the discretion of the commanding officer or the range OIC. Adjacent ranges within a range complex that support aviation live-fire should be marked or lighted to facilitate aircrew identification of their assigned range.

d. Rotary wing flanking fire.

(1) RW gun and rocket weapon systems will be used to provide flanking fire, as shown in figure 11–1, when a minimum lateral distance of 100 m or 15 degrees between exposed troops and firing aircraft gun target line is maintained. Additionally, exposed troops must be positioned outside the WDZ/SDZ footprint.

(2) Positive means will be employed to ensure that the firing unit knows the location of the maneuver units while fire support is being provided.

(3) Only non-explosive projectiles will be used for RW flanking fire.

(4) The route and location of maneuver units and the firing aircraft providing flanking fire support will be described and briefed in detail. The use of cockpit displayed graphics, and/or recognizable natural/manmade terrain features, and other means of friendly position marking in accordance with table 11–1 will be used by exposed troops.

(5) Firing aircraft must positively identify the front line trace of exposed troops prior to engagement.

e. Rotary wing/tilt rotor door gunnery operations.

(1) Door gunnery operations will be conducted according to the appropriate gunnery manuals (FM 3–04.140 for the Army). Marine Corps units will follow the procedures established in the Marine Aviation Weapons and Tactics Squadron One (MAWTS–1) Aerial Gunnery Manual and appropriate tactical manuals for the specific type aircraft.

(2) All personnel on the aircraft will wear at least single-hearing protection when firing weapons.

f. Rockets.

(1) *Training operations.* Training operations conducted in conjunction with aerial rocket firing must be suspended if winds or gusts exceed 30 knots.

(2) *Rotary wing aerial rockets.* The launch angle in degrees equals launcher QE in mils divided by 17.7 plus the aircraft pitch in degrees. For articulating launchers, use the maximum articulated QE possible plus the aircraft pitch in degrees.

(a) Maximum launcher QE shall not exceed 160 mils.

(b) Maximum range of the 2.75-inch rocket with the MK66 motor is 12,000 m launched at 45 degrees and below standard air density.

(c) Firing of the M267 multipurpose sub-munition practice rocket is prohibited if crosswinds exceed 20 knots. The M75 practice sub-munition may be either inert or have an explosive spotting charge. Inert M75 sub-munitions are painted blue and have no ram air decelerator. M75 sub-munitions with explosive spotting charges are painted blue with a brown band and have bright yellow ram air decelerator. The dud M75 has a clean underside. The functioned M75 has soot and burn marks on the underside of the sub-munition body. An armed M231 fuse for the M75 is identified by a slider that sticks out from the sub-munition body about 1.3cm. This slider has a red tip and a "V" notch.

(d) Firing of the M261 HE multipurpose sub-munition rocket is prohibited in training by the Army only, and/or on Army ranges.

(e) Units using the 2.75" (70mm) aerial rocket are authorized to fire the M255A1 Flechette service munition on range complexes (such as a multipurpose range complex, multipurpose training range, digital multipurpose range complex, digital multipurpose training range, or digital air/ground integration range that support the SDZ. There is no requirement to limit firing of the M255 flechette into permanently duded impact areas. The M255A1 presents a hazard similar to the M267 training rocket and is not inherently hazardous. Prudent safety measures and operational practices can minimize risks and burdens to range personnel. RMAs (Army), RCOs (Marine Corps) should identify specific moving armor targets and stationary armor targets for flechette engagements. Aviation crews will typically engage while conducting running fire and close to a range of 1,500 m to launch the munition. Selected targets should be in the most downrange third of the range complex. This will minimize expended flechette damage to vehicle tires and risks to range personnel. RMAs (Army), RCOs (Marine Corps) may employ magnet sweepers to clear expended flechettes from highly travelled service roads. Flechette rockets that fail to function should be marked upon discovery and referred to EOD personnel for removal.

(3) *The following restrictions apply when firing the 2.75in folding fin aerial rocket with the M278 IR illumination warhead:*

(a) The pilot/gunner will ensure that the M278 IR illumination warhead deployment occurs at least 1,500 ft AGL on training areas. Deployment of the flare below 1500 ft AGL significantly increases the risk of ground fires.

(b) The pilot/gunner will mitigate the hazard of spent rocket motor impact. The spent rocket motor impact point can be approximately 700 m to 1200 m beyond the point of flare deployment.

(c) When the rocket with the M278 warhead is fired in the vicinity of friendly troops and personnel in an uncovered position, ground personnel shall wear PPE Level 1.

(d) Pilots must exercise extreme caution when operating in the vicinity of IR illumination flares. Once the flare burns out, the flare container and parachute will not be visible during its decent.

g. *Inertial aided munitions.*

(1) Inertial aided munitions are smart weapons, such as a GBU-38 joint direct attack munition, GBU-44 Viper Strike, or Griffin small tactical munition, that employ Global Positioning System as an inertial aid to acquire target location.

(2) Aircraft employing inertial aided munitions in a bomb-on-coordinate mode or aircraft employing any ordnance in a system delivery mode on coordinates only will adhere to the following prior to release:

(a) Aircrew will confirm the accuracy of the aircraft navigation and weapon delivery systems. For the Marine Corps, aircrew will confirm aircraft health, weapon health, and coordinate in accordance with current MAWTS-1 or weapon school technical training procedures.

(b) Aircrew will ensure accurate receipt and entry of target coordinates and that they come from a valid target source. These coordinates will be verified via read-back from target data entry displays or will be cross-checked with mission planning data or range guides but must include one other person, in addition to the pilot, verifying coordinate/elevation accuracy (either in-flight or during mission planning). Examples of valid target sources include, but are not limited to RMAs (Army), RCOs (Marine Corps), Joint terminal attack controllers, range guides, or forward air controller-airborne qualified aircrew.

(c) Aircrew will use all means available to verify accuracy of target coordinates/elevation, and that the coordinates are within the anticipated target area. Examples of available means include but are not limited to forward looking infrared radar, synthetic radar aperture map, heads-up display cueing, other aircraft sensors, terrain pointer, map plots, data links, radio communications, talk-ons with JTACs, RMAs (Army), RCOs (Marine Corps), and other aircrew members.

(d) Aircrew will confirm and adhere to published range operating procedures and restrictions.

h. *GBU-44 Viper Strike, Griffin.* Both the Viper Strike and Griffin weapon systems have post-launch debris that will fall to the ground after the weapon is launched from the aircraft. This includes aft-launch tube covers, support brackets, and parachutes (Viper Strike). Although the probability of someone being injured by these lightweight items is low, it is recommended that the area below the launch point be cleared of personnel for a radius of 2,000 m.

i. *AGM-114 HELLFIRE missiles.* AGM-114 HELLFIRE missiles shall not be fired if there are tail winds in excess of 20 knots. Further restrictions for HELLFIRE missiles can be found in paragraphs 11-10, 11-11, and 11-12.

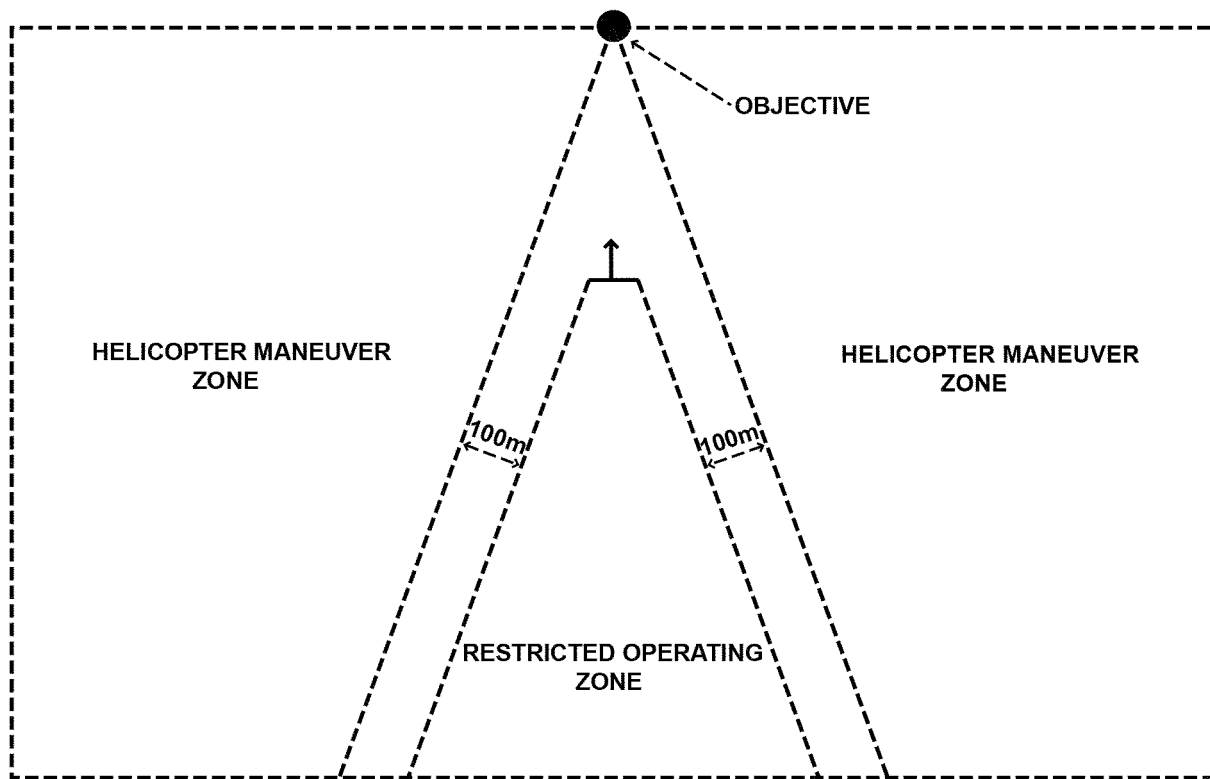

Figure 11-1. Flanking fire restrictions

Table 11-1
Friendly position marking requirements

Method	Day	Night	NVG	NVS
Smoke	X			
IR smoke	X			
Signal mirror	X			
IR laser			X	
Glint tape			X	
Combat identification panels	X			X
Strobe		X	X	
IR strobe			X	
IR panel				X
Chem light		X	X	
AN/PAQ-4			X	
VS-17 panel	X			
Spot light		X	X	
MRE heater				X
AN/PEQ-2			X	

11-5. Unmanned aircraft systems considerations

a. Operator/air mission commander requirements.

(1) All operators who control UAS platforms/payloads within range complex training airspace shall participate in a range safety brief and become familiar with installation range regulations prior to operating within the complex.

(2) Air mission commanders who oversee UAS operations/training within range complex training airspace shall participate in a range safety brief and become familiar with installation range regulations prior to conducting operations within the complex.

(3) Air mission commanders shall take all measures necessary to ensure training/operations are conducted within assigned SUA or other authorized operating area and that unmanned aerial vehicles and all effects (for example, munitions/laser) are contained within assigned boundaries.

(4) UAS operational unit commanders shall ensure that all UAS performance, air worthiness and related requirements meet system safety standards prior to operating unmanned aerial vehicles within assigned range space.

b. Operator qualifications for platform/payload operations, aviation weapons delivery/terminal guidance.

(1) Army.

(a) Operators will successfully complete an approved qualification course, or qualification, or transition training in accordance with an approved program of instruction.

(b) Operators will demonstrate platform, payload, and weapon systems proficiency in accordance with TC 1-600 and FM 3-04.140.

(2) Marine Corps. Marine operators will demonstrate proficiency in accordance with the appropriate TMS T&R manual.

c. Fielded systems.

(1) Ensure range operations (Army), range control (Marine Corps) personnel are familiar with the flight characteristics of UAS involved in range aviation operations.

(2) Ensure all UAS operations are scheduled and approved by range operations (Army), range control (Marine Corps). Include the coordination radio frequencies, loss of contact procedures, climb/descent corridors, operating altitudes, and proximity to other aircraft and personnel.

(3) UAS operators shall maintain radio contact with the range operations firing desk (Army), range control (Marine Corps) or the OIC at all times.

(4) Unless accomplished during initial coordination, request and receive clearance from the range operations firing desk (Army), range control (Marine Corps) or control agency personnel before changing UAS assigned position, altitude, or route. If UAS loses uplink for a short period of time, the aircraft will automatically execute return home procedures so that the uplink can be reacquired.

(5) For ordnance delivery, operate UAS in VMC and when the weather is forecast to remain VMC throughout the flight.

(6) If operating with weapons, arm ordnance for delivery only when the aircraft is within the SUA and in a position from which, if released, the ordnance will remain within the designated impact area.

(7) The UAS operator will notify the range operations firing desk (Army), range control (Marine Corps) and or OIC when the UAS has completed ordnance delivery and when departing the range.

(8) The mission commander will maintain the responsibility for the safe operation of payload and platform.

d. Developmental/experimental unmanned aircraft systems. If the UAS has not yet been fielded, provide range operations (Army), range control (Marine Corps) personnel current reliability information and a "worst case" depiction of potential range, direction and SUA point of departure for developmental/experimental UAS in the event that loss of contact procedures fail.

e. Unmanned aircraft systems operations conducted outside restricted areas and warning areas. UAS operations conducted outside restricted areas and/or warning areas shall comply with the provisions of applicable FAA and DODDs, notices and current certificates of authorization or waiver.

f. Loss of communications. Firing will be suspended immediately upon loss of communications with the range operations firing desk (Army), range control (Marine Corps), the OIC, or firing elements.

g. Loss of link. For systems with preprogrammed lost link loiter capability, the UAS operator will provide range safety with the location and flight profile of the loiter pattern.

11-6. Weapon danger zone program methodology

a. WDZ identify the minimum area necessary to contain munitions and hazardous fragments within the installation or range boundary that result from air-to-ground ordnance delivery operations.

b. The principle objective of the WDZ program is to assist range operations (Army), range control (Marine Corps) in executing safe range operations. WDZ program methodology identifies weapon impact point probabilities from a variety of platforms and parameters, thus providing them with a scientific basis for making sound range planning decisions and to facilitate training readiness. It enables range personnel to:

(1) Contain ordnance and fragmentation within range boundaries.

(2) Identify appropriate containment levels and risk associated with the areas identified as needing specific risk analysis, or the area of critical concern.

(3) Identify possible or improved target locations.

(4) Modify allowable delivery ground tracks to eliminate or reduce hazards.

(5) Identify the best locations for range modifications or improvements.

(6) Design a new target area/range.

c. The methodology is based on a combination of weapon modeling/simulation data and actual impact data. Each WDZ incorporates a probability distribution function which provides the information necessary to perform a quantitative risk assessment to evaluate the relative risk of an identified profile.

d. Every type of air-to-ground aviation ordnance should have a WDZ. This WDZ (the weapons footprint) is calculated based on the type of aircraft delivering the weapon (for example, F/A-18 Hornet aircraft or OH-58D Kiowa helicopter), the delivery parameters of the aircraft (dive angle, airspeed, altitude, and so forth), type of ordnance being delivered (for example, MK-82 bomb and AGM-114 HELLFIRE missile), and the level of containment desired.

e. WDZs may be further affected by terrain, artificial barriers, or other compensating factors such as target type (wood, metal) and soil hardness.

f. Representative examples and descriptions of WDZs are reviewed in chapter 3.

11-7. Weapon danger zone tool

a. WDZs for FW, RW and UAS are generated with the WDZ tool as part of the RMTK package. The WDZ tool is a Geographic Information System-based application that is available to operational planners and RMAs (Army), RCOs (Marine Corps) in both desktop and web-based versions.

b. The WDZ tool will lead the user through the WDZ generation process. It will help range managers determine aircraft type, ordnance, and delivery parameters that are permissible for each target.

c. A record (electronic or hard copy) of the analysis of each target engaged during the training evolution will be maintained at range operations (Army), range control (Marine Corps). The WDZ manager (library function) may be used to meet this requirement.

d. Range operations (Army), range control (Marine Corps) personnel will publish air-to-ground ordnance delivery regulations for each target in the range SOP, specifying ordnance permitted as well as any restrictions (dive angle, airspeed, run-in heading) associated with that target or specific training event. Proper target analysis will include, but is not limited to the following:

(1) Approved ordnance for the range target.

(2) Type of deliveries allowed.

(3) Run-in restriction if required for a specific weapon or delivery.

(4) Approved containment boundary.

(5) Weather minimums if more restrictive than standard visual flight rules operating requirements.

(6) Any other constraints or restrictions required to allow weapons delivery on the identified target.

e. For deliveries not contained within the SOP, the using unit may submit proposed WDZs to the range operations office (Army), range control office (Marine Corps) for consideration.

f. WDZs will be developed and tested as new weapons, aircraft, and delivery parameters are produced and enter the operational inventory. Appropriate higher headquarters will ensure WDZs are available prior to levying new weapons training requirements or introducing new aircraft and weapons into the DOD inventory.

g. The WDZ tool is an integral application of RMTK and may also be accessed on the web:

(1) Army: Sustainable Range Program Web site - <https://srp.army.mil>.

(2) Marine Corps: RTAM Web site - <https://rtam.tecom.usmc.mil>.

11-8. Applying the weapon danger zone tool

a. *Containment.*

(1) The "containment" of a weapon system's performance envelope, impact footprint, and/or associated debris fields require the surface area (land or sea) to be protected by purchase, lease, or other restriction to exclude personnel from that area. This general policy ensures safety will be maximized and consistent with mission requirements.

(2) The WDZ tool allows selectable levels for weapons containment ranging from 1:10,000 probability to a 1:1,000,000 probability of a munition escaping the containment area (for inert ordnance) or a live weapon's fragment escaping the containment area (for live ordnance).

(3) The safety standard for Army and Marine Corps ranges is 1:1,000,000.

(a) *Fixed wing aircraft.* All WDZs will be generated with a minimum containment standard of 1:1,000,000 (99.9999 percent).

(b) *Rotary wing and tilt rotor aircraft.* All WDZs will be generated with a minimum containment standard of 1:1,000,000 (99.9999 percent).

(c) *Unmanned Aircraft System.* All WDZs will be generated with a minimum containment standard of 1:1,000,000 (99.9999%).

(4) For the Army, if the selected containment level is too large to support necessary operations, a smaller containment level may be accepted with the completion of an appropriate risk analysis and deviation process referenced in AR 385–63/MCO 3570.1C, and FM 5–19. For the Marine Corps, if the selected containment level is too large to support necessary operations, contact Commanding General, Training Education Command, Range and Training Area Management Branch (C465), 3300 Russell Road, Quantico, VA 22134–5001 for assistance in development of the appropriate risk analysis and deviation process referenced in AR 385–63/ MCO 3570.1C FM 5–19, and MCO 3500.27B.

(5) Subject to deviation, WDZs may be further reduced by selecting the option to mitigate for terrain.

(6) Deviations approved for WDZs extending beyond installation boundaries must be based on the ability to contain projectiles, hazardous fragments, laser beams, and both vertical and horizontal ricochets sufficiently within the installation boundaries, and area under military control (such as leased land or training areas and facilities acquired through memorandum of understanding or memorandum of agreement). Probability of hazardous fragment escapement must not present a greater than 1:1,000,000 hazard to the public.

b. Mission essential personnel.

(1) Placement of mission essential personnel (MEP) within a WDZ may be authorized by the RMA (Army), RCO (Marine Corps) or the operational commander of the training or exercise.

(2) Essential personnel are those personnel directly related to the employment of live/inert ordnance (air, surface, or sea fires) in an exercise or evaluation on a training range in a training/evaluation scenario (all those people that are receiving/giving the training and or receiving/giving the evaluation). This would include JTACs, tactical air control parties, maneuver elements, fires elements (air/land/sea), and instructors/evaluators.

c. Risk analysis.

(1) The WDZ tool risk analysis function can show the probability of impacts within a selectable, defined area of the WDZ. This function will help define the risk associated with a specific location within the WDZ, dependent upon the weapons system employed and the size of the area at risk or area of critical concern.

(2) Area of critical concerns may involve the placement of MEP (such as, JTAC or tactical air control parties) or the location of towers or other facilities within the WDZ. For area of critical concerns that contain MEP, the RMA (Army), RCO (Marine Corps), or the OIC will use the WDZ Tool Risk Analysis function and will not accept greater risk than the safety standard of 1:1,000,000 unless a thorough risk assessment, risk management process has been completed per reference FM 5–19 and MCO 3500.27B.

(3) Risk may be mitigated by moving the location of the personnel, decreasing their vulnerability through the use of terrain features or bunkers, or reducing the dimensions of the area.

(4) Non-participating personnel must be outside the WDZ at all times.

11–9. Rotary wing surface danger zones

a. General.

(1) SDZs will be used for RW aircraft when WDZ generation is not available.

(2) For firing from a hover, SDZs will be superimposed over the GTL at each firing point. On running fire courses, SDZs will be superimposed over each anticipated firing position along the course. These SDZs will begin at the start-fire line and move along the course to each anticipated firing point to the cease-fire line.

(3) A range may contain several different hover fire points or running fire courses where multiple aircraft can fire at the same time. The resultant SDZ will be a composite formed by individual SDZs. When multiple aircraft are firing at the same time, controls will be established to ensure the safety of all participating aircraft.

(4) The lateral limits of the target area determine the left and right limits of fire, which will begin at any point beyond the start-fire line provided the minimum safe distance (for example, ricochet area, Areas A and B) for the weapon system being fired is maintained from the aircraft to the point of impact. For running fire, Distance X will be measured from the cease-fire line.

b. Guns and Cannon. SDZ requirements for safe firing of 7.62mm, .50 caliber machine guns, and 20mm and 30mm cannons from RW aircraft are given in chapter 4.

c. Rockets.

(1) SDZ requirements for the safe firing of the 2.75 in folding fin aerial rocket weapon systems from rotary-wing aircraft for hover and running fire are given in table 11–2 and figures 11–2 and 11–3, and are the basis for constructing the SDZ.

(2) The distance from the cease-fire line or disarm line to the closest edge of Area B will be Distance X for the weapon system being fired.

(3) Areas A and B are not required for inert/training munitions. For HE warhead-equipped rockets, Areas A and B are 300 m wide. For flechette warhead-equipped rockets, Area A is 300 m wide and Area B is 400 m wide.

(4) For mixed loads, Distance X is based on the rocket having the greatest range for the highest expected launch angle.

d. Tube-launched, optically-tracked, wire-guided missile surface danger zone. For TOW antitank guided missiles contained in chapter 7, these apply to basic TOW, Improved TOW, TOW 2A and TOW 2B missiles fired from Army and Marine Corps helicopters.

11–10. HELLFIRE missile (semi-active laser) designation criteria

a. Due to the large size of the HELLFIRE WDZ /SDZ and the limited range of the designators, it may be necessary to place designator operators within HELLFIRE WDZ s/SDZs during training operations. Remote laser designation will take place from a position at least 150 m laterally from the launch aircraft to target line, while adhering to the designator zone requirements. Three designator zones have been established within the WDZ /SDZ and are depicted in figures 11–4, 11–5, 11–6, 11–7, and 11–8.

(1) Prohibited designator zone. No designator operators are allowed in this zone because of the unacceptable probabilities associated with the following hazards:

(a) The missile seeker can track the laser backscatter energy at the exit aperture of the designator or along the path of the laser beam.

(b) The probability of random missile engagement errors is the highest within this zone.

(2) Protected designator zone. Designator operators are not vulnerable to a normally functioning missile tracking the laser backscatter energy in this zone. However, there is a possibility that the missile will track and impact an obstruction such as trees, grass, or hills near the designator operator if it is accidentally illuminated by the laser beam. There is a possibility of a random missile failure impacting within 150 m of a designator operator in this zone. Therefore, the number of personnel in this area must be kept to a minimum consistent with mission requirements.

(a) Only ground designator operators will occupy the protected designator zone. Ground designator operators will wear approved flak jackets/IBA, protective helmets, and laser eye protection, and be located in protected positions such as surrounded by sand bags that enclose the designator operator.

(b) The designator will have a clear, unobstructed line of sight to the target. Ensure designator line of sight is unobstructed across the entire path of a moving target during the time of missile flight to impact.

(c) Ground designator operations must ensure that they do not inadvertently lase through battlefield obscurants such as smoke, obstacles, or dust caused by other personnel, vehicles, and so forth.

(3) Unprotected designator zone. Although designator operators are not vulnerable to a normally functioning missile tracking backscatter or false targets in this zone, there is still a possibility of being injured by a random missile failure.

(a) As a minimum, ground designator operators will wear approved flak jackets/IBA, protective helmets, and laser eye protection.

(b) Airborne designator operators must ensure that they are either over ground conditions that do not create dust or are at an altitude where rotor downwash does not create dust.

(c) Ensure designator line of sight is unobstructed across the entire path of a moving target during the time of missile flight to impact.

b. The angle formed between the designator target line and the MTL shall never be greater than 60 degrees (see fig 11–9). Designator operators will be inside this 60 degree angle.

c. If the missile appears to fly straight up (errant missile), stop lasing the target.

d. Potential hazard areas depicted in the latest safety of use messages (SOUMs) identify missile fly-out zones of greater than 10^{-6} probability.

e. Firing conditions for all non-mission-essential personnel will be located outside HELLFIRE missile WDZs/SDZs.

(1) The position of the launch platform and designator operators is critical to the safe use of the HELLFIRE missile weapon system. Controls must be established to ensure proper launcher direction, designator direction, designator boresight, and target coordinate verification prior to missile launch.

(2) When firing in the lock-on-after-launch (direct/indirect mode), the angle between the designator target line and the MTL will be 30 degrees. If the lock-on-after launch (direct-fire mode) is required, the target must be visible to the launch crew to assure proper aircraft alignment.

(3) Ground designator rain hood and port covers must always be used when supplied as a system option to reduce clear air laser energy backscatter (reflected laser energy) emitted from the designator toward the missile.

f. Laser danger zone parameters outlined in MIL–HDBK–828B apply to designators being used with HELLFIRE missiles.

g. Compliance with the HELLFIRE designator exclusion zone as described in Joint Publication (JP) 3–09, is required to preclude the designating platform from being targeted by the missile. All HELLFIRE gunnery participants, including UAS operators, must be aware of and comply with this exclusion zone. Pilots in command are responsible for ensuring missiles are not launched while a designator is in the exclusion zone.

11-11. AGM-114 A/F and AGM-114 K/N HELLFIRE missile weapon danger zones/surface danger zones

a. Direct fire/indirect fire HELLFIRE missile weapon danger zones/surface danger zones. The direct fire and indirect fire WZs/SDZs support the AGM-114 A/F and AGM-114 K/N HELLFIRE for firing at fixed targets for both Army and Marine Corps RW aircraft. These WZs/SDZs include the effects of HE warhead functioning at the edge of the impact area. However, an additional 216 m must be added to Areas A and B to allow for the larger warhead for the AGM-114 M/N. Because of the unique shape and size of the WZs/SDZs, the actual scaled (1:50,000) safety fans must be requested from the respective ACOM, ASCC, and DRU safety office (Army). In this chapter, the AGM-114F includes the AGM-114FA model.

b. When firing in a lock-on-after-launch mode, a 30 degree angle will be used for all AGM-114 WZs/SDZs.

(1) Direct-fire WZ/SDZ (see fig 11-4). This WZ/SDZ will be used for AGM-114 A/F missiles and, for the Marine Corps, only the AGM-114 K/N missile with the following launch modes and conditions:

(a) Aircraft configured in accordance with latest SOUM.

(b) Lock-on before launch with remote designation.

(c) Lock-on after launch (direct-launch mode) with remote designation.

(d) Lock-on after launch (direct-launch mode) with autonomous designation and proper designation delay:

1. For AGM-114A missiles, use a minimum delay of 3 seconds and a maximum delay of 10 seconds.

2. For AGM-114B/F missiles, use a minimum delay of 3 seconds and a maximum delay of 5 seconds.

3. For designation delay as calculated for range to target after missile separation, always add 1 second to the designation (separation) delay times when counting from trigger pull.

(2) Indirect-fire WZ/SDZ (see fig 11-5). This WZ/SDZ will be used for AGM-114 A/F and AGM-114 K/N HELLFIRE missiles with the following launch modes and conditions:

(a) This WZ/SDZ will be used with any HELLFIRE missile operational mode not described in paragraph 11-11b(1) above and with remote or autonomous designation. For the Army RW aircraft, firings of the AGM-114 K/N are restricted from utilizing direct-fire WZ/SDZ. The HELLFIRE operational mode launch parameters and performance envelopes are described in FM 3-04.140 and the latest SOUM.

(b) To minimize backscatter for Lock-On-Before-Launch (LOBL) autonomous engagements use the following target offsets:

1. 3 to 5 degree target offset.

2. Always offset the missile launch angle toward the side of the launch platform on which the missile resides to reduce the chance of interference with autonomous tracking.

3. No offset is necessary when using remote designation.

c. Expanded direct fire/expanded indirect fire weapon danger zones/surface danger zones - Army rotary wing aircraft. Due to excessive missile roll rates induced by interactions between specific Army RW aircraft and their associated launchers, two additional WZs/SDZs have been established to compensate for possible missile error (roll tip-off error). The expanded direct (AGM-114 A/F) and expanded indirect (AGM-114 A/F and K/N) WZs/SDZs (see figs 11-6 and 11-7) are required for all Army RW aircraft. However, based on specific aircraft launcher configurations and firing modes, certain Army RW aircraft may be allowed to use the standard direct/indirect WZs/SDZs as indicated in figures 11-4 and 11-5. Refer to table 11-3 and the latest Army HELLFIRE SOUM to determine which aircraft and under which configurations and firing modes are acceptable for firing under the standard direct/indirect WZs/SDZs.

d. Altitude restrictions. HELLFIRE WZs/SDZs as depicted in figures 11-4, 11-5, 11-6, and 11-7 are based on a maximum launch altitude of 300 ft AGL. If firing above 300 ft AGL then the 'Radial' extent of the WZ/SDZ is increased by 1 m per additional foot of launch altitude. Minimum clearance airspace will be 20,000ft above launch altitude. Refer to the latest SOUM associated with HELLFIRE delivery to ensure appropriate parameters are met.

e. Area F. An area to the rear of the launch point 30 m wide (15 m to each side of the launcher) and 50 m long when aircraft are at or below 300ft AGL. Hazards are launch motor blast, hazardous noise levels, overpressure, and debris. Serious casualties or fatalities may occur to personnel occupying Area F; therefore, occupation of it is not authorized.

11-12. AGM-114 P/P+/R HELLFIRE missile

AGM-114 P/P+/R WZs. All WZs/SDZs will be developed using the RMTK WZ tool. These missiles are authorized for high altitude firings in order to support additional platforms such as UAS and C-130 Hercules aircraft in accordance with the latest HELLFIRE SOUM.

11-13. HELLFIRE missile maximum altitude

The maximum altitude for HELLFIRE missile firing is 20,000 ft (6,096 m) above launch point.

**Table 11-2
Aerial rocketry surface danger zone criteria**

Launch	Distance X					
	MK40 Rockets		MK66 Rockets		Rockets (MPSM)	
	Hover	90 knots	Hover	90 knots	Hover	90 knots
0 degrees	3,000 m	3,000 m	3,000 m	3,000 m	N/A ¹	N/A ¹
2 degrees	3,000 m	3,700 m	3,000 m	4,500 m	N/A ¹	N/A ¹
4 degrees	3,600 m	4,600 m	3,800 m	5,600 m	N/A ¹	N/A ¹
6 degrees	5,000 m	5,300 m	5,400 m	6,400 m	N/A ¹	N/A ¹
8 degrees	5,600 m	5,900 m	6,100 m	7,000 m	N/A ¹	N/A ¹
10 degrees	6,100 m	6,400 m	6,700 m	7,500 m	6,800 m	7,600 m
12 degrees	6,500 m	6,800 m	7,200 m	7,900 m	7,300 m	8,000 m
14 degrees	6,800 m	7,100 m	7,600 m	8,200 m	7,700 m	8,300 m
16 degrees	7,100 m	7,400 m	7,800 m	8,600 m	7,900 m	8,700 m
18 degrees	7,300 m	7,600 m	8,000 m	8,700 m	8,100 m	8,800 m
20 degrees ²	7,500 m	7,800 m	8,300 m	8,900 m	8,400 m	9,000 m
22 degrees ²	7,700 m	8,000 m	8,500 m	9,100 m	8,600 m	9,200 m
24 degrees ²	7,900 m	8,200 m	8,700 m	9,200 m	8,800 m	9,300 m
26 degrees ²	8,000 m	8,300 m	8,900 m	9,300 m	9,000 m	9,400 m
28 degrees ²	8,300 m	8,400 m	9,000 m	9,400 m	9,100 m	9,500 m
30 degrees ²	8,500 m	8,500 m	9,100 m	9,500 m	9,200 m	9,600 m

Legend for Table 11-2:

N/A=Not applicable

MPSM=multipurpose submunition

Notes:

¹ During hover fire launch angles below 10 degrees are inadequate for proper aiming. Rockets will impact short of target.

² Launch angles between 20 degrees and 30 degrees are not recommended as they exceed 6,000 m range-to-target and result in undesirable aircraft attitude.

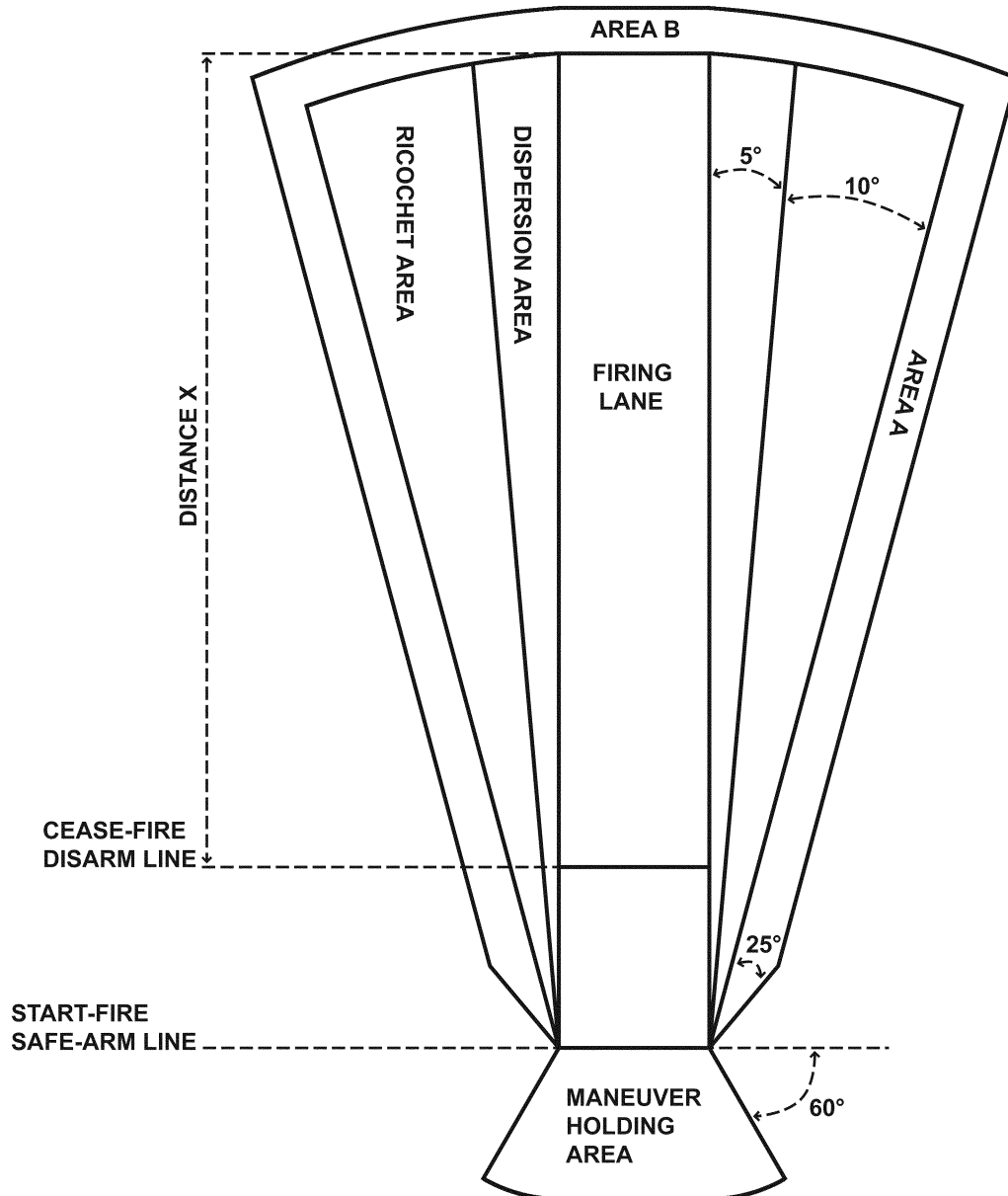

Notes:

¹ Normal vertical danger zones with the parameter of table 11-2 are 5,000 ft AGL. The length and width of the firing lane will be determined by the OIC. Minimum recommended width is 50 m.

Figure 11-2. Surface danger zone for firing aerial rocketry at ground targets Figure 11-2.

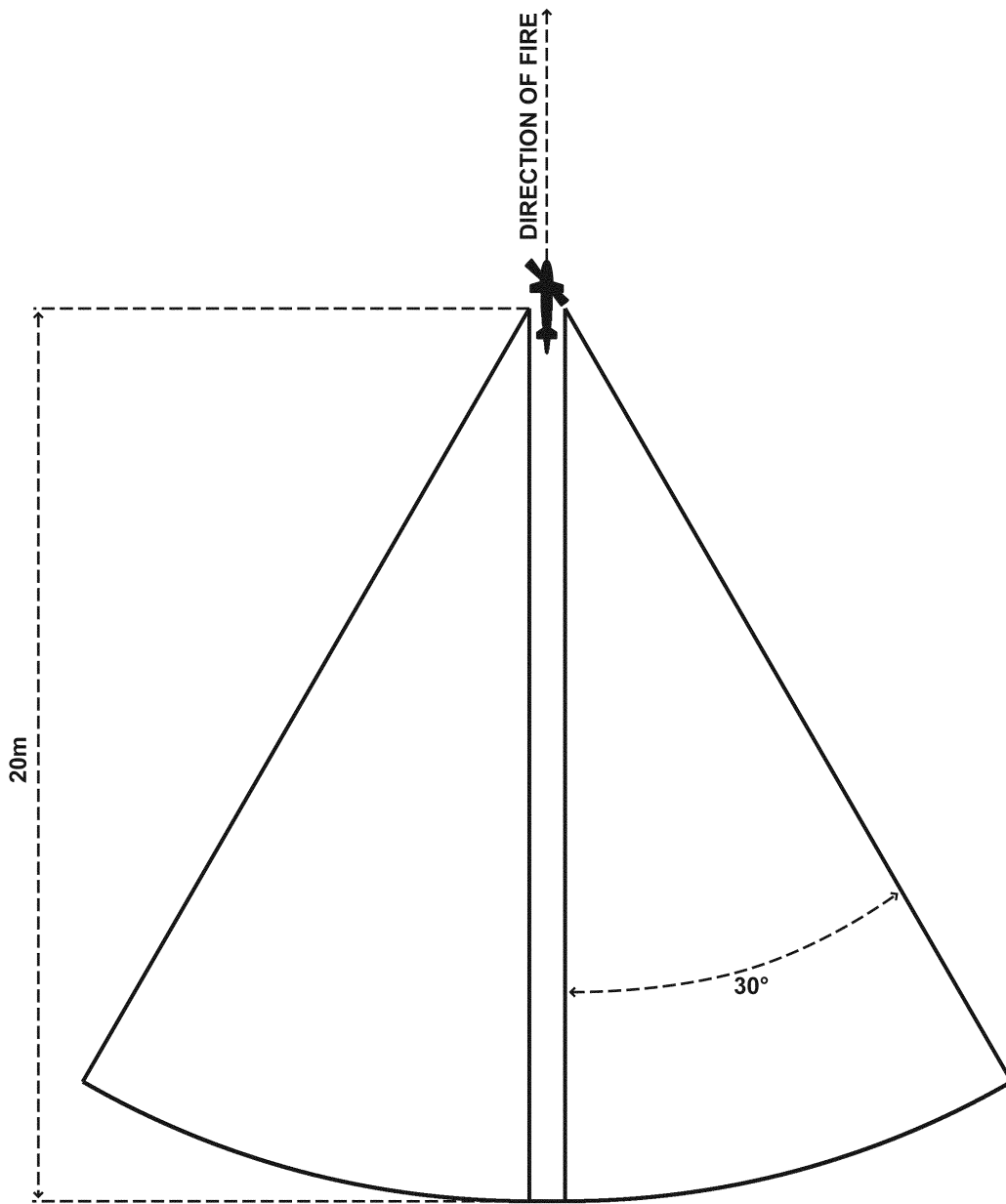

Figure 11-3. Area F, rear blast area for hover firing and loading or unloading aerial rockets

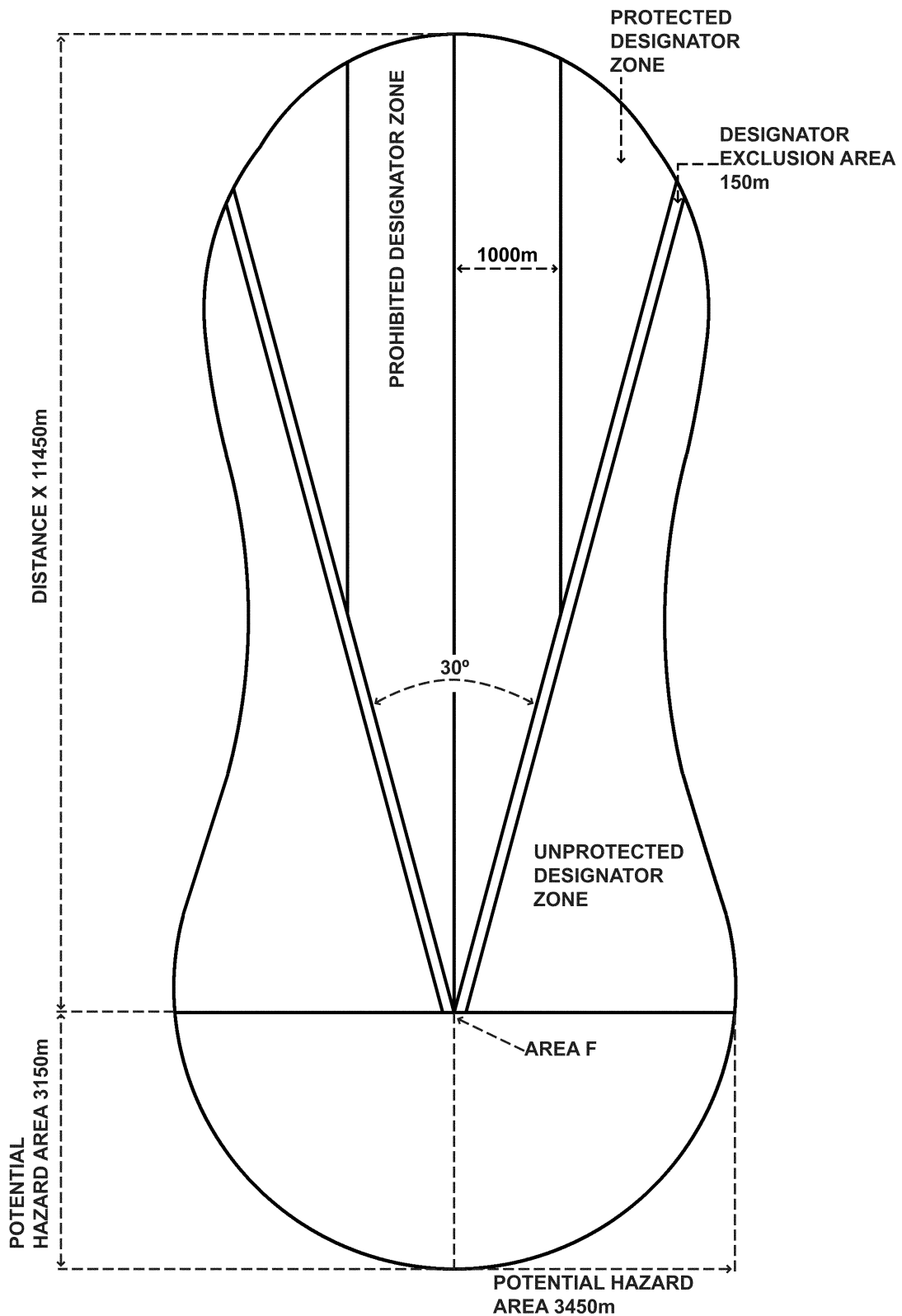
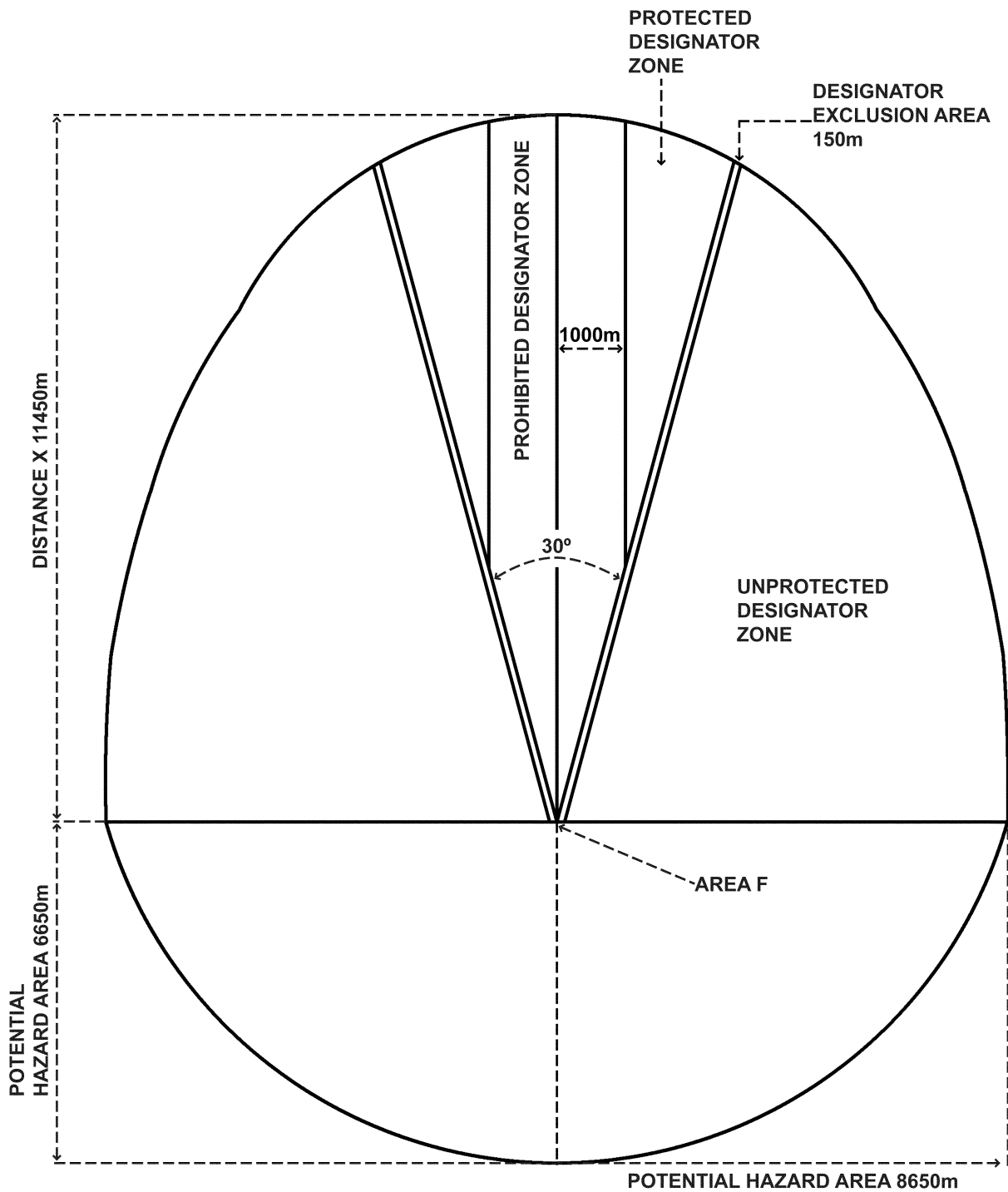

Figure 11-4. Directed fire surface danger zone for firing AGM-114 A/F HELLFIRE laser-guided missiles in direct launch at fixed target (Lock-On-After-Launch autonomous or Lock-On-Before-Launch with remote designation)



Notes:

¹ Based on a maximum launch altitude of 300 ft AGL. If firing above 300 ft AGL then the 'Radial' extent of the WDZ/SDZ is increased by 1 m per additional foot of launch altitude.

² When firing in a Lock-On-After-Launch (LOAL), 30 degree angle will be used.

Figure 11-5. Indirect fire weapons danger zone/surface danger zone for firing AGM-114 A/F HELLFIRE laser-guided missile in the indirect launch mode with remote designation) at fixed target or firing the AGM-114 K/N missile in either the direct or indirect launch mode

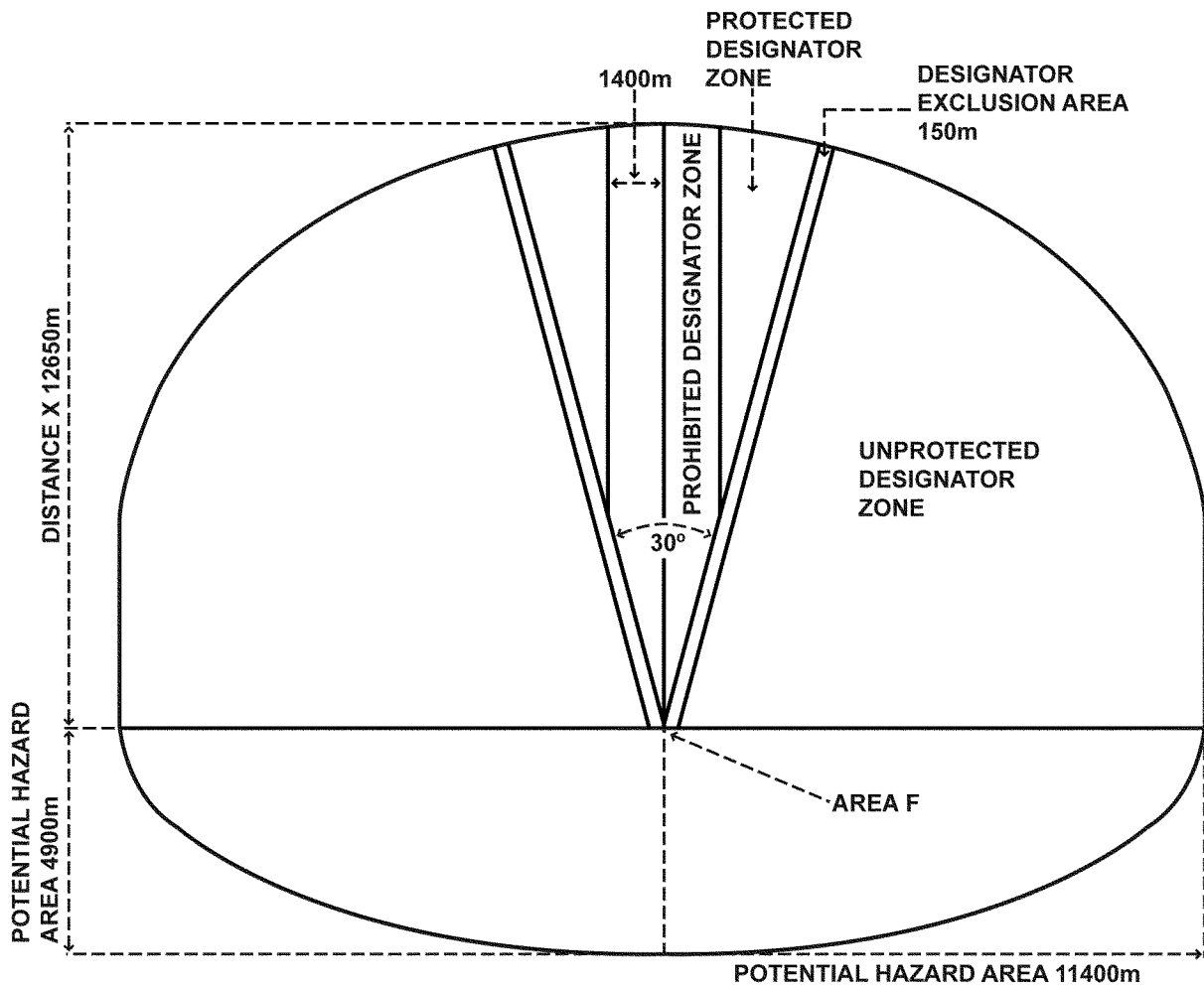

Figure 11-6. Expanded direct weapons danger zone/surface danger zone (Army RW only) for firing AGM-114 A/F HELLFIRE laser-guided missile with associated missile tip-off error in direct launch mode at fixed target (Lock-On-After-Launch autonomous or Lock-On-Before-Launch with remote designation)

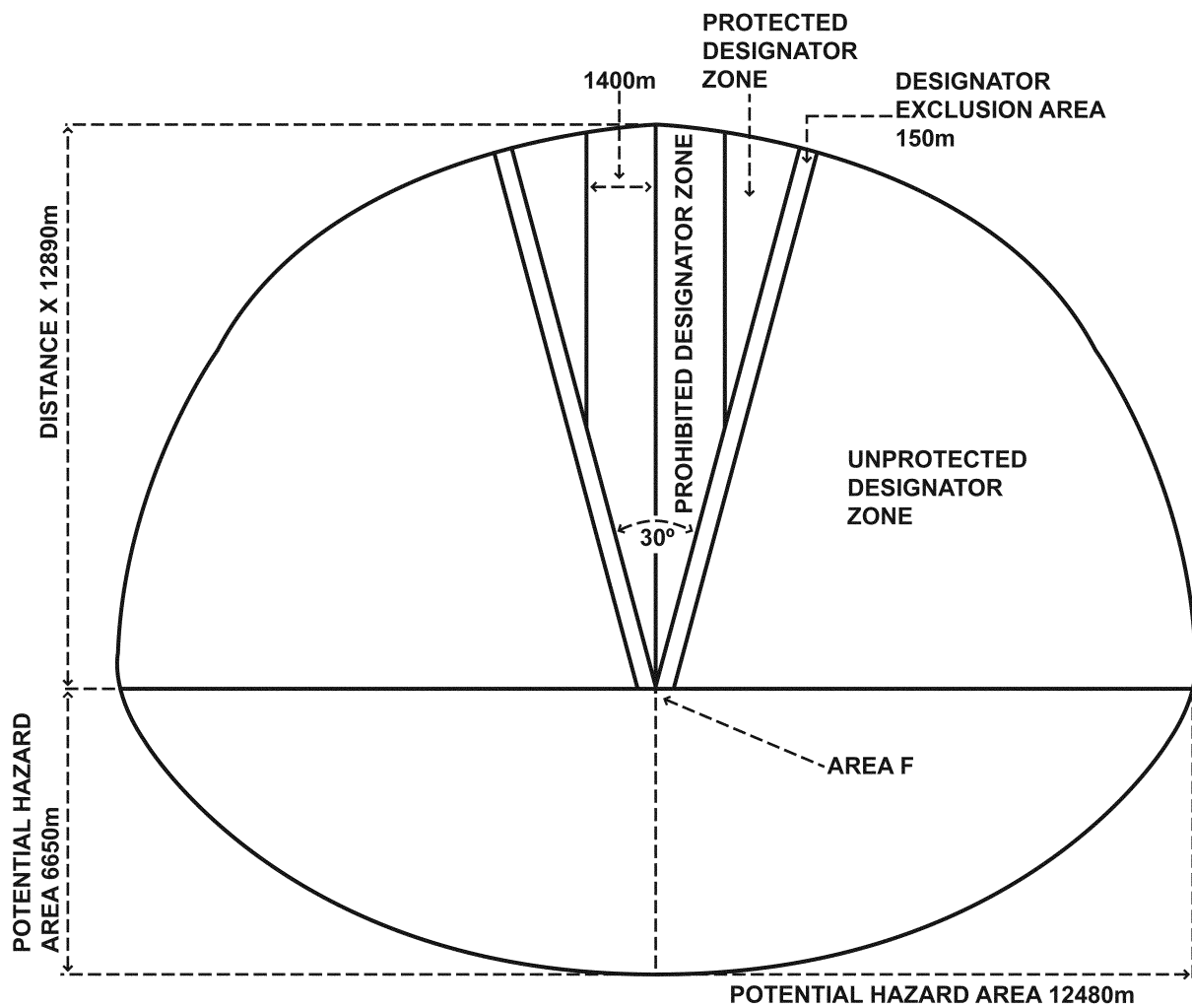

Figure 11-7. Expanded indirect weapons danger zone/surface danger zone for firing AGM-114 A/F HELLFIRE laser-guided missile with associated tip-off error in the indirect launch mode (Lock-On-After-Launch with remote designation) at fixed target or firing the AGM 114-K/N missile with associated tip-off error in either the direct or indirect launch mode

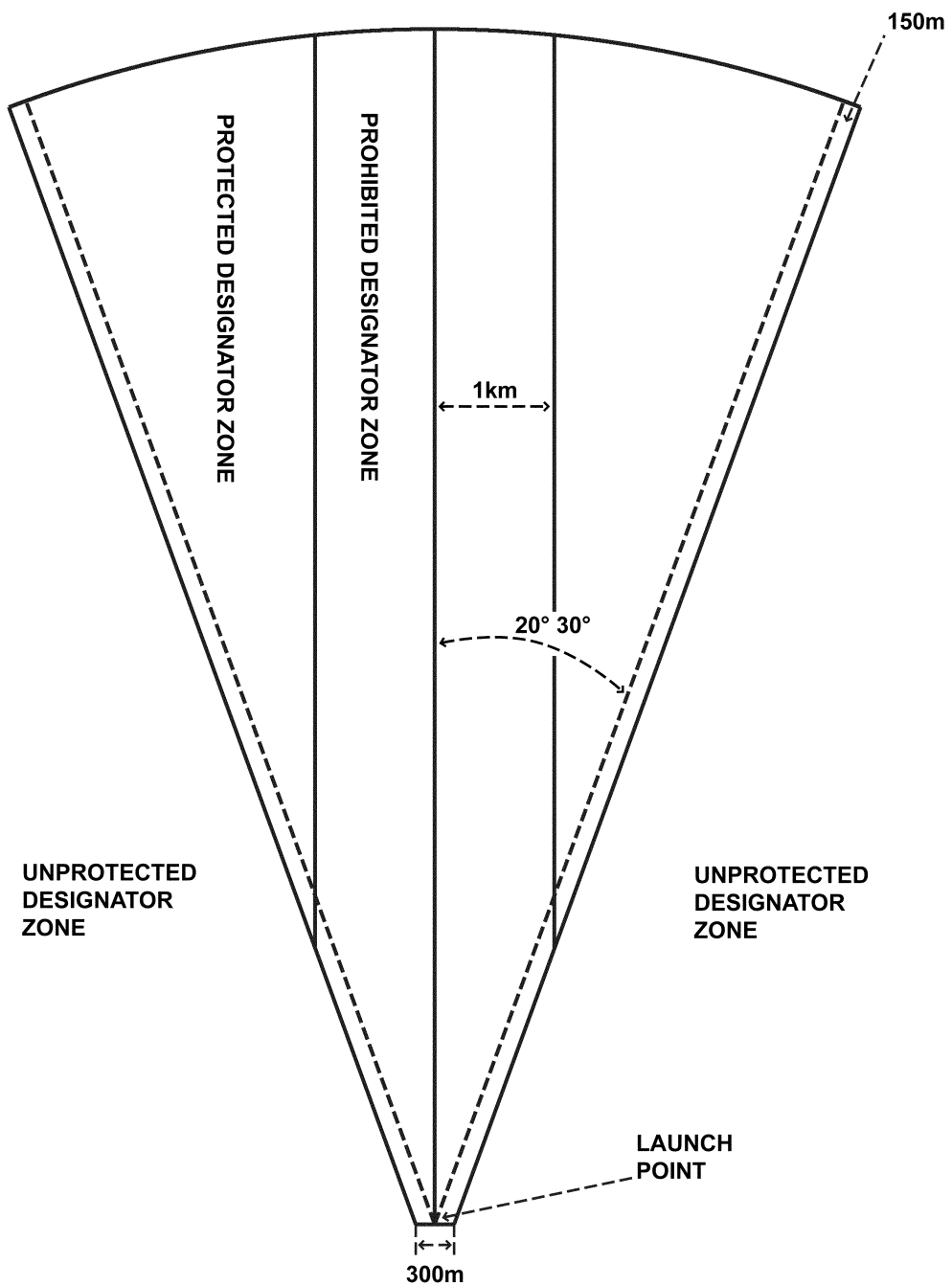
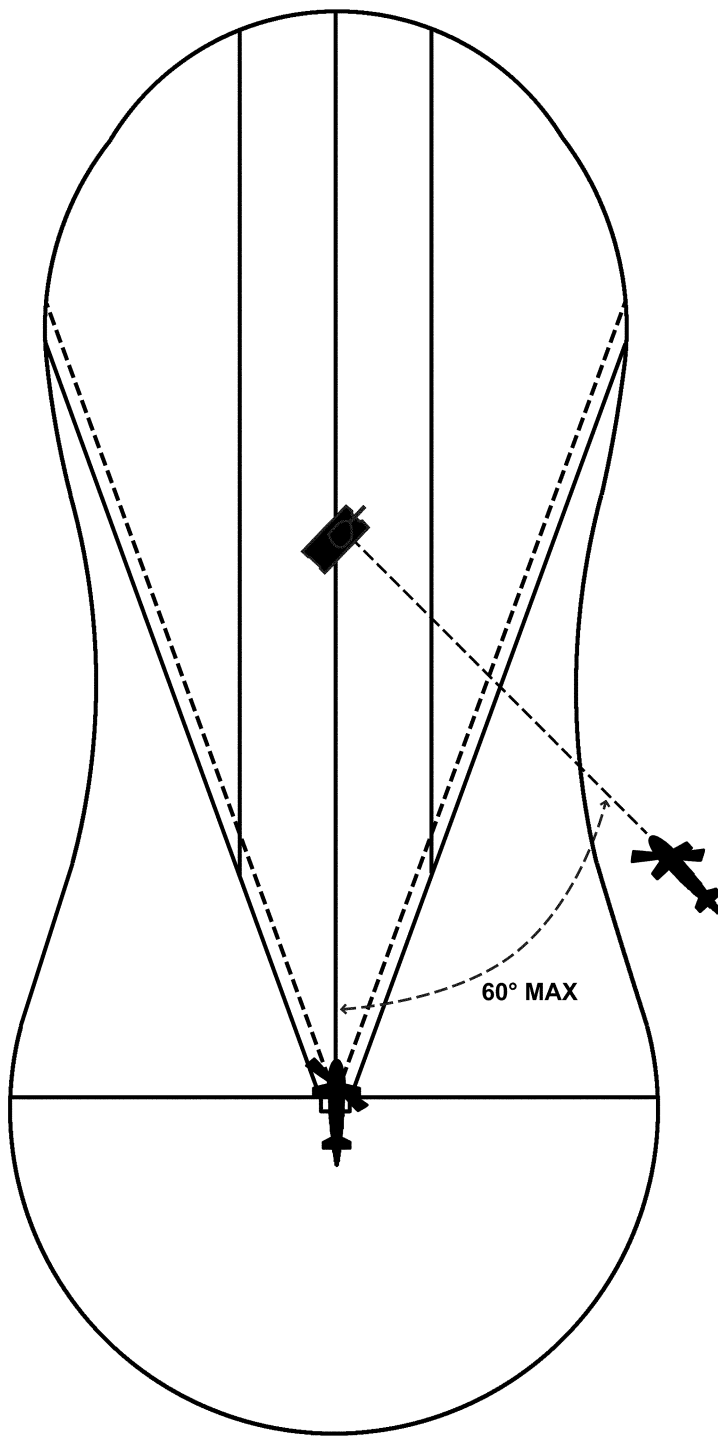

Figure 11-8. Designator zones for use with AGM-114 HELLFIRE laser-guided missile surface danger zone



Notes:

¹ The angle between the designator target line and the MTL must never be greater than 60 degrees.

Figure 11-9. Maximum designation angle for AGM-114 HELLFIRE missile laser designators

Table 11-3
Army rotary wing HELLFIRE missile firing modes and restriction requirements

SDZ	Aircraft	Configuration restriction	Launch mode	Laser missiles
Direct fire:				
Direct	AH-64A/D Apache	Yes	LOB ¹	
	OH-58D Kiowa	Yes	LOAL-D	A - F
	AH-6 Little Bird	Yes		
	MH-60L direct action penetrator	No		
Expanded direct	All	No	LOB ¹ LOAL-D	A - F
Indirect fire:				
Indirect	AH-64A/D Apache	Yes		
	OH-58D Kiowa	Yes	All	A - F, K, M, N, Q
	AH-6 Little Bird	Yes		
	MH-60L direct action penetrator	No		
Expanded indirect	All	No	All	A - F, K, M, N, Q

Notes:

¹ With remote designation only.

Chapter 12

Air Defense Artillery Weapon Systems

12-1. General

- a.* An SOP will be established to prevent accidents during the firing of guided missiles and rockets. The SOP will—
- (1) Expand the specific duties and responsibilities of the range OIC, RSO, and trajectory officer (if appropriate).
 - (2) Relate to the special characteristics of the specific missile or rocket to be fired and the physical characteristics of the firing area.
 - (3) Specify procedures for conducting operations involving the use of high-pressure air (or compressed gases). Operations will be supervised by well-trained personnel who are knowledgeable of the Air Defense Artillery Weapons System.
- b.* Changes in the type of missile or rocket to be fired or changes in local conditions make it mandatory that the SOP be revised or a new SOP prepared prior to firing.

12-2. Firing conditions-general requirements

The following safety precautions will be observed for firing guided missiles and heavy rockets:

- a.* When units are firing at independent locations in the same general area, a commissioned OIC will be responsible for each independent firing location (Marine Corps).
- (1) Safety at each firing location is the responsibility of the SRSO. A RSO and trajectory safety officer will be designated to assist the SRSO. Additional personnel may be detailed to assist the SRSO, as required.
 - (2) Situations may arise that are not addressed in this pamphlet, but in the opinion of the SRSO, may result in an unsafe condition. Conversely, situations may arise in which firing a missile or rocket, rather than destroying a missile or rocket in flight, is considered the safest course of action. The decision must be made locally based upon prevailing conditions.
 - (3) Guided missiles and rockets will not be launched on a trajectory that allows the missile or rocket to pass over personnel or materiel, except as specifically authorized by the installation RMA (Army), RCO (Marine Corps), this pamphlet, and the appropriate TM.
 - (4) Guided missiles and rockets will be fired within a time limitation (window) established by the installation range operations organization (Army), range control organization (Marine Corps). If firings cannot be accomplished within the prescribed window, a new firing schedule will be obtained.
 - (5) Intermediate and high altitude guided missiles (such as the MIM-23B Improved Hawk (Army) or MIM-104 PATRIOT) fired for training will be equipped with self-destruct systems capable of destroying the missile during flight or terminating the trajectory in a safe area.

(6) Missiles equipped with inert or practice warheads will be provided with a system capable of terminating the powered trajectory or destroying the aerodynamic characteristics of the missile to ensure its destruction.

(7) When a flight termination system is used to control a system's SDZ, the trajectory safety officer will have the capability to command destruct missiles independently of all actions of firing and trajectory control crews.

(8) The number of personnel engaged in handling, assembling, or firing guided missiles and heavy rockets will be kept to the minimum required to maintain efficient operations and mission accomplishment.

(9) Shorting plugs and other safety devices will be removed only to conduct tests or in final preparation for firing.

(10) Smoking is prohibited at firing pads, ready storage sites, and assembly sites. No-smoking signs will be prominently displayed. Smoking is also prohibited on any vehicle used to transport propellants or explosives. The possession of matches or any other flame producing devices while working with or transporting propellants or explosives is prohibited.

(11) Suitable firefighting equipment as determined by the installation fire marshal will be readily available during all firings.

(12) Personnel engaged in handling hazardous materials or exposed to hazardous operations or conditions will use protective clothing and equipment as prescribed by appropriate TMs and FMs. Approved hearing protection will be worn by all personnel within the hearing hazard zones defined in the manuals for each system.

(13) Except for the use of approved testing equipment in accordance with established procedures, guided missiles and heavy rockets will be isolated from sources of electrical energy (such as, sparks, static discharges, or stray current) that may cause ignition of the propellant or electro-explosive devices.

(14) Decontamination equipment appropriate for the type of propellants, oxidizers, active chemicals, batteries, or hazardous fuels at the site will be readily available during firing operations.

b. Firing and support personnel will not occupy positions within any portion of the SDZ except as specifically authorized by this pamphlet.

c. When occupation of the SDZ is authorized, protective shelters will be used which have been inspected by the installation safety director and facility engineer.

d. Fire control personnel will employ positive protection, such as keyed firing panels, to prevent premature firing of a guided missile or heavy rocket.

12-3. FIM-43 Redeye guided missile (Army)

a. Firing conditions.

(1) The entire Redeye SDZ will be cleared of all personnel except those actively engaged in missile firing. This number will be held to the minimum compatible with efficient operations.

(2) Procedures and precautions in appropriate TMs and FMs will be followed during Redeye missile firings.

(3) No firings will be made on incoming targets that normally pass over the launch area allowing target or target debris to impact in the area upon intercept. Instructors and any other personnel exposed to rocket motor blast will wear personal protection equipment required for the gunner in appropriate TMs.

b. Surface danger zone.

(1) Redeye guided missile SDZ requirements are given in figure 12-1 and consist of an impact area and Areas A, B, and F. The SDZ is based on the maximum ballistic range of the Redeye since there is no provision for command destruct by the trajectory safety officer. Distance X for the Redeye guided missile is available from the respective ACOM, ASCC, and DRU safety office. ACOMs, ASCCs, and DRUs that have Redeye guided missiles get Distance X from the U.S. Army Aviation and Missile Command.

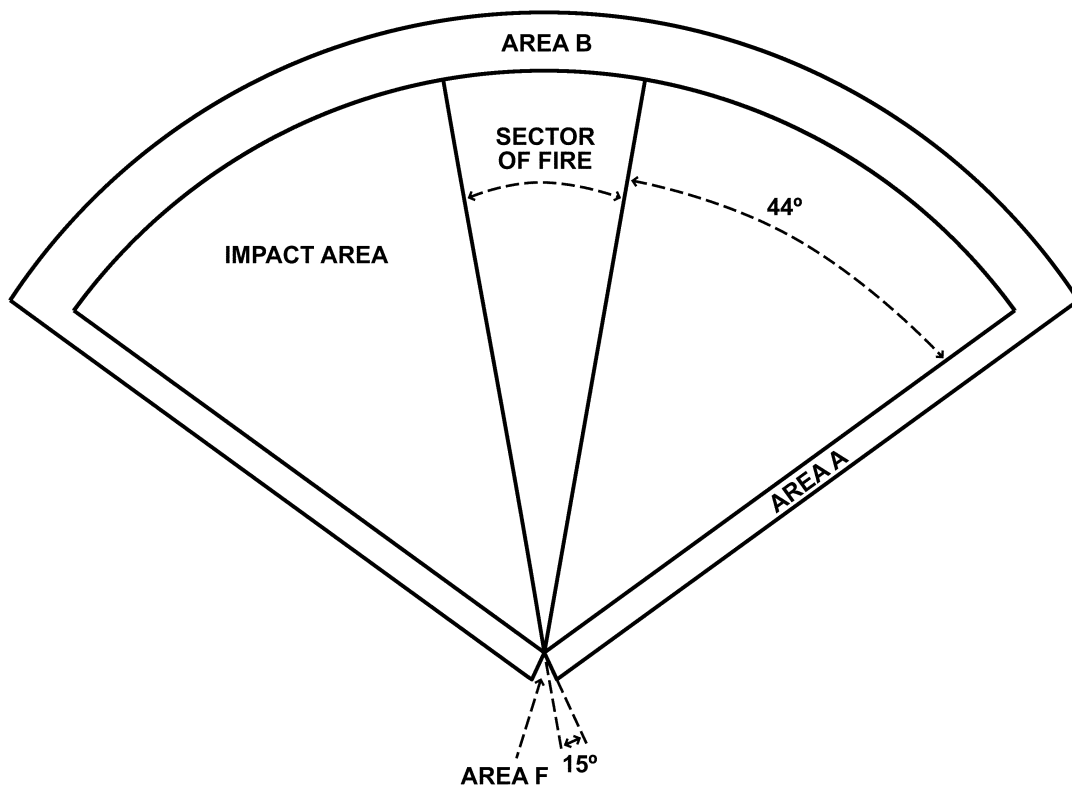

Figure 12-1. Surface danger zone for firing Redeye guided missile at moving targets

(2) Impact areas will normally contain fragments and debris from missiles launched within its sector of fire. The sector of fire is that portion of the impact area in which targets may be engaged. Boundaries of the sector must be designated by positioning azimuth limit markers forward of the launcher position and all firings must be accomplished within these limit markers. Impact areas consist of an area 44 degrees to each side of the sector of fire and extending down range to the maximum ballistic range of the missile.

(3) Area A is the lateral secondary danger zone. This area is normally adequate to contain the effects of warheads functioning at the edge of the impact area. It consists of areas 50 m wide on each side of the impact area and extending downrange to the maximum ballistic range capability of the missile.

(4) Area B is the far secondary danger zone. This area is normally adequate to contain the effects of a warhead functioning at the downrange edge of the impact area. It consists of an area 100 m in depth beyond the impact area and Area A.

(5) Area F is the launcher danger zone extending to the rear of the firing position. It consists of an area 15 degrees to the outside of the rearward extension of the sector of fire boundaries and the area between the rearward extensions of the sector of fire. This angle also defines the rear limit of Area A. The rear distance in both cases will be a connecting radius 12.2 m from the launcher.

12-4. FIM-92 Stinger guided missile

a. Firing conditions.

(1) The entire Stinger guided missile SDZ will be cleared of all personnel except those actively engaged in the missile firing. This number will be held to the minimum compatible with efficient operations.

(2) Stinger weapon systems will not be fired over the heads of unprotected personnel because of the hazards from launch motor impact and the sustainer motor plume.

(3) All training firings will be limited to a maximum elevation angle of 50 degrees (40 degrees target elevation angle plus 10 degrees super elevation) to minimize the possibility of a malfunctioning missile traveling to the rear of the launch position.

(4) Procedures and precautions in appropriate TMs and FMs will be followed during Stinger firings. No firings will be made on directly incoming targets which normally pass over the launch area allowing targets or target debris to

impact in the area upon intercept. Instructors and any other personnel exposed to the rocket motor blast will wear personal protective equipment as required for the gunner in the appropriate TMs.

b. Surface danger zone.

(1) Stinger guided missile SDZ requirements given in figure 12-2 apply to both air-to-air and ground-to-air launched missiles. This SDZ, based upon maximum ballistic range of the missile, consists of an impact area and Areas A, B, and F. Self-destruct features designed to terminate missile flight within the SDZ were not considered in establishing range safety requirements. Maximum ballistic range (Distance X) for Stinger in each launch mode is given below.

(a) Ground-to-air guided missiles.

1. Basic Stinger: 11,900 m.
2. Reprogrammable microprocessor Stinger: 13,000 m.
3. Reprogrammable microprocessor block 1 Stinger: 14,000 m.

(b) Air-to-air guided missiles, same as ground-to-air except Distance X increases 0.60 m for every 0.30 m of altitude AGL at time of launch.

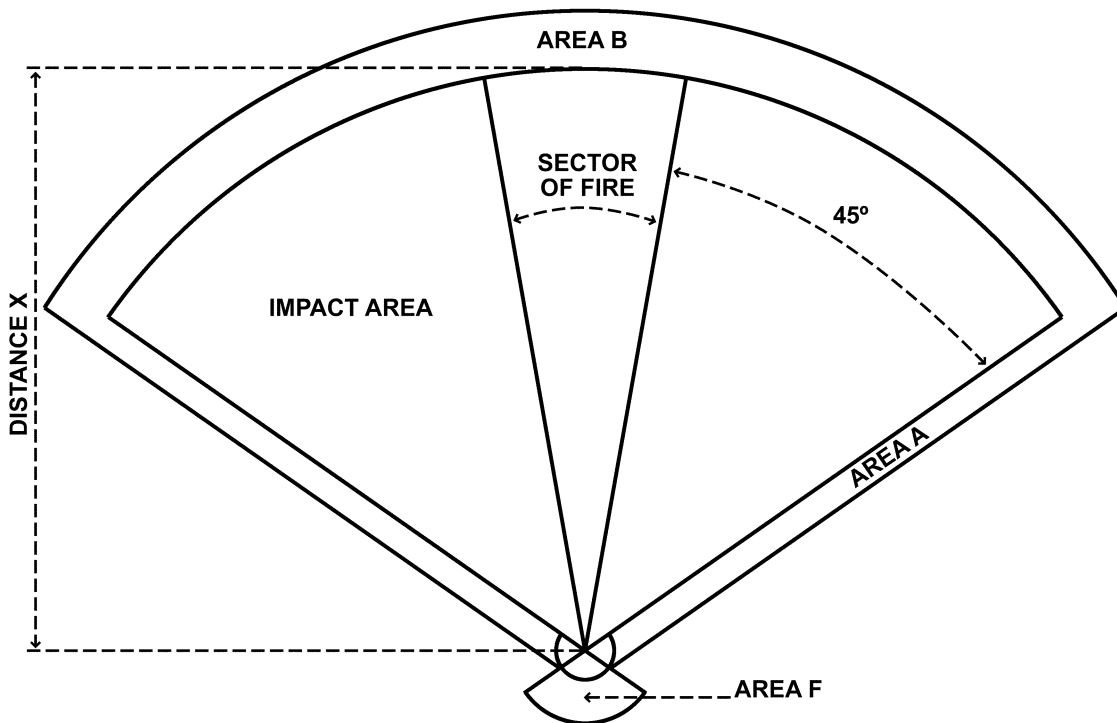

Figure 12-2. Surface danger zone for firing Stinger guided missiles at moving targets

(2) Impact areas will normally contain fragments and debris from missiles launched within its sector of fire. The sector of fire is that portion of the impact area in which targets may be engaged. The boundaries of the sector will be designated by positioning azimuth limit markers forward of the launcher position. All firings must be accomplished within these limit markers. The impact area for moving targets consists of an area 45 degrees to each side of the sector of fire and extending downrange to the maximum ballistic range of the missile. For stationary (hovering) and directly outbound moving targets the impact area may be reduced to 40 degrees on each side of the sector of fire.

(3) Area A is the lateral secondary danger zone that is adequate to contain the effects of warheads functioning at the edge of the impact area. It consists of areas 50 m wide on each side of the impact area and extending downrange to the maximum ballistic range capability of the missile.

(4) Area B is the far secondary danger zone that is adequate to contain the effects of a warhead functioning at the downrange edge of the impact area. It consists of an area 100 m in depth beyond the impact area and Area A.

(5) Area F shown in figure 12-3 is the launcher danger zone extending to the rear of the firing position. It is further divided into a primary danger area and two caution areas.

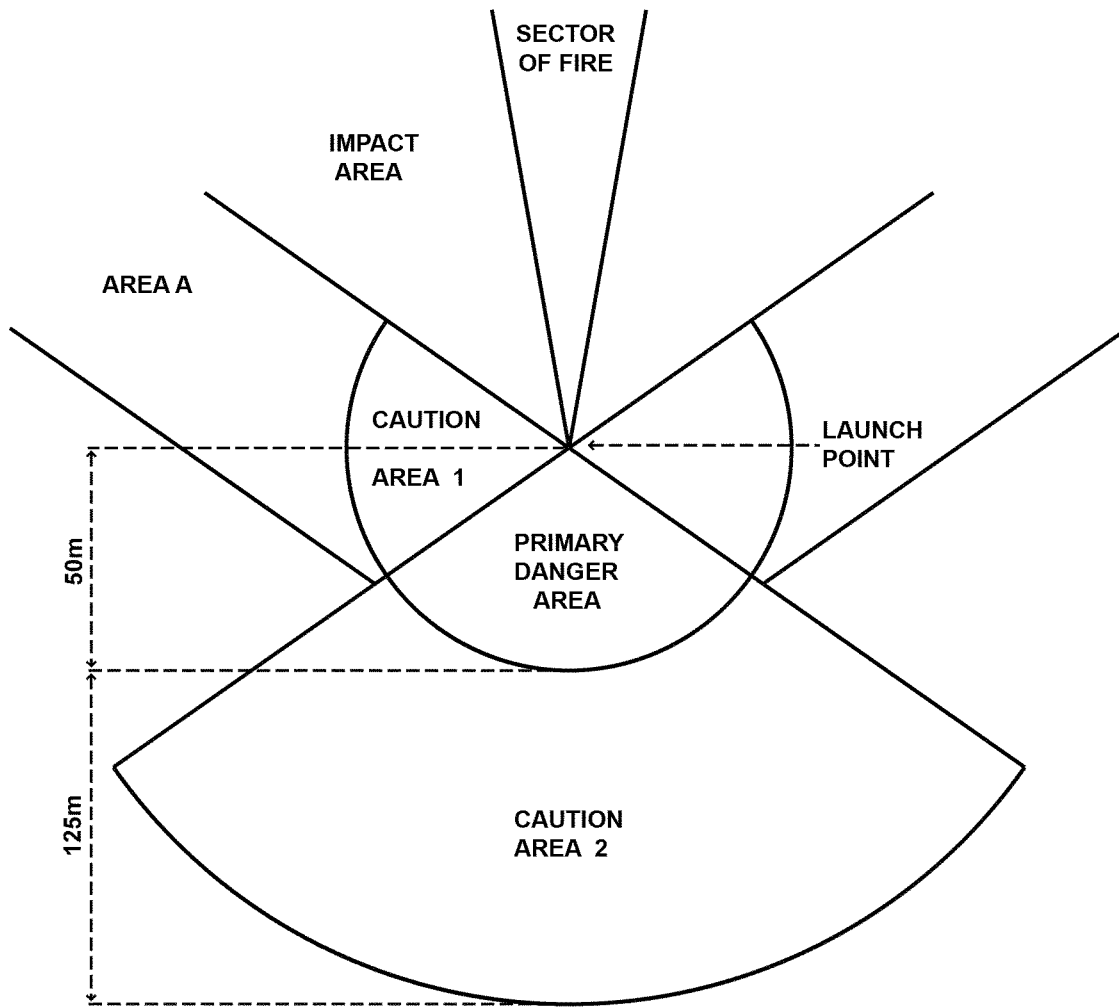

Figure 12-3. Surface danger zone, Area F, for firing Stinger guided missile

(a) The primary launcher danger area has a radius of 50 m boundaries that lie along rearward extensions of the impact area boundaries. Personnel are not permitted in this area during firings.

(b) Caution Area 1 also has a radius of 50 m. Its boundaries are the primary launcher danger area and the impact area. Any personnel in this area must be protected from hazardous noise levels and flying ground debris.

(c) Caution Area 2 extends to the rear of the launcher with a radius of 125 m. Its boundaries are straight lines drawn between the rearward extension of the impact area boundaries and the intersection of the 125 m radius. Occupation of Caution Area 2 is permitted when all personnel are wearing approved single hearing protection.

(6) The Stinger SDZ does not ensure protection from aerial targets that may be used for training firings. Target SDZs must be incorporated into overall Stinger firing operations by the RSO.

c. *Stinger surface danger zone criteria.* These apply to the AN/TWQ-1 Avenger, M6 Linebacker, man-portable air defense systems, and Light Armored Vehicle launch platforms, both stationary and on the move. When firing on the move, extend the Stinger/Avenger SDZ along the route of maneuver. The target flight path establishes left and right limits of fire.

12-5. MIM-72 Chaparral guided missile

a. *Firing conditions.*

- (1) The entire SDZ will be cleared of all personnel prior to firing a missile except as authorized below.
- (2) Procedures and precautions outlined in appropriate Chaparral TMs and FMs will be followed during firings. Only the minimum personnel required to fire and maintain safety surveillance of the firing will be permitted in the

SDZ at the time of missile firing. All personnel, except the fire unit gunner, will occupy appropriate protective shelters that have been located and constructed in accordance with USACE drawings and will protect against any fragments or debris that may be expected from the missile as a result of warhead functioning. The protective shelters must be examined by the installation safety director and facility engineer to determine if the shelters will provide adequate personnel protection.

(3) Danger areas for debris from target drones with normal controlled flights should be contained within the impact area for the Chaparral missile. Impact areas for target drones which have abnormal flights or which go out of control are not covered herein.

b. Surface danger zone.

(1) Chaparral SDZ requirements are given in figure 12-4 and consists of an impact area and Areas A, B and F. This SDZ is based on the maximum ballistic range of the missile since there is no provision for command destruct by the trajectory safety officer.

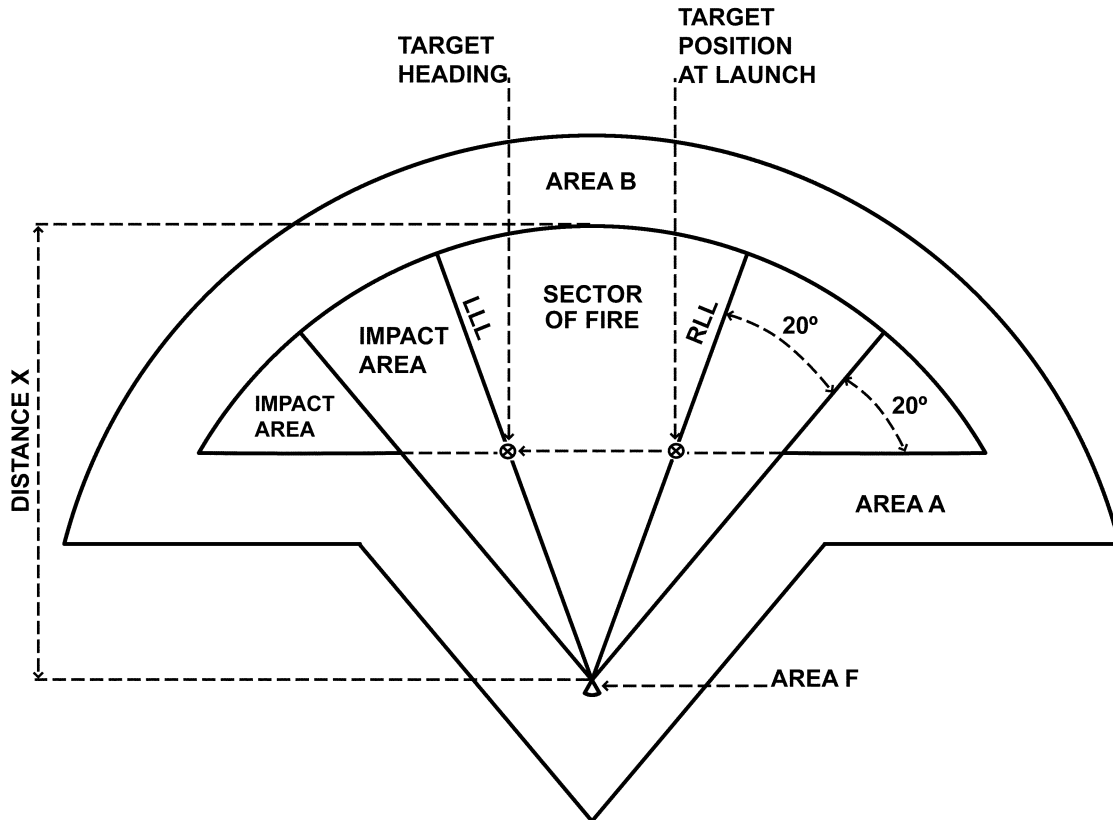

Figure 12-4. Surface danger zone for firing Chaparral guided missiles at a point in space

(2) Impact areas, which include the sector of fire and 20 degrees on each side, are used for firings at directly outgoing targets. When firings are made at off-tail or crossing targets, the minimum impact area is increased by 20 degrees beyond the heading of the target. The boundaries of the sector of fire must be designated by positioning azimuth limit markers forward of the launcher position. All firings must be accomplished within these limit markers.

(3) Area A is the lateral secondary danger zone. This area is normally adequate to contain the effects of warheads functioning at the edge of the impact area. The 600 m width for this area and for Area B is the distance required for the MK 48 series warheads.

(4) Area B is the downrange secondary danger zone. It is normally adequate to contain the effects of a warhead functioning at the forward edge of the impact area.

(5) Area F is the back-blast area that lies totally within Area A. Area F is defined as an area bounded by lines 30

degrees on each side of the missile axis and extending 100 m to the rear which should adequately contain primary and secondary motor exhaust and debris.

12-6. MIM-104 PATRIOT guided missile

The PATRIOT service practice and other firings with the PATRIOT guided missile weapon system conducted at or under the control of White Sands Missile Range, NM or McGregor Range, Fort Bliss, TX will be in accordance with the safety requirements of AR 385-63/MCO 3570.1C, this pamphlet, and the training or test range SOPs.

a. Firing conditions.

(1) The PATRIOT guided missile SDZ will be cleared of all personnel prior to firing a missile except as authorized below.

(2) A missile flight corridor drawn on a map or a scale drawing of the firing range is provided for use by the trajectory safety officer. The trajectory safety officer is provided with a means of accurately tracking and plotting the course of the missile and a means of causing the destruction of the missile if the missile intersects the flight corridor boundary. The flight corridor has lateral boundaries that are parallel to and 2 km closer to the centerline than the lateral boundaries of the impact area. The lateral boundaries of the flight corridor extend to meet the boundary of the impact area beyond the intercept point. Flight corridor boundaries from the launch point intersect the lateral boundaries of the flight corridor at Distance L from the launch point.

(3) Only those personnel actively engaged in fire and control of the missile as specified by the appropriate TMs and FMs will be permitted in the SDZ at the time the missile is fired. The number of personnel authorized access should be the absolute minimum that is compatible with efficient operation. Personnel should, when possible, occupy shelters that are located a minimum of 90 m from the launcher and approved by the garrison safety manager.

(4) Danger areas for debris from target drones that have normal flight paths should be contained within the impact area for PATRIOT guided missiles. Impact areas for target drones that have abnormal flight paths or which go out of control are not covered herein.

b. Surface danger zone.

(1) The SDZ includes an impact area, Areas A and B (see fig 12-5), which represents the areas on the ground that will contain the debris from the PATRIOT missile that is destroyed in flight. Labels for SDZ areas are unique to the PATRIOT guided missile.

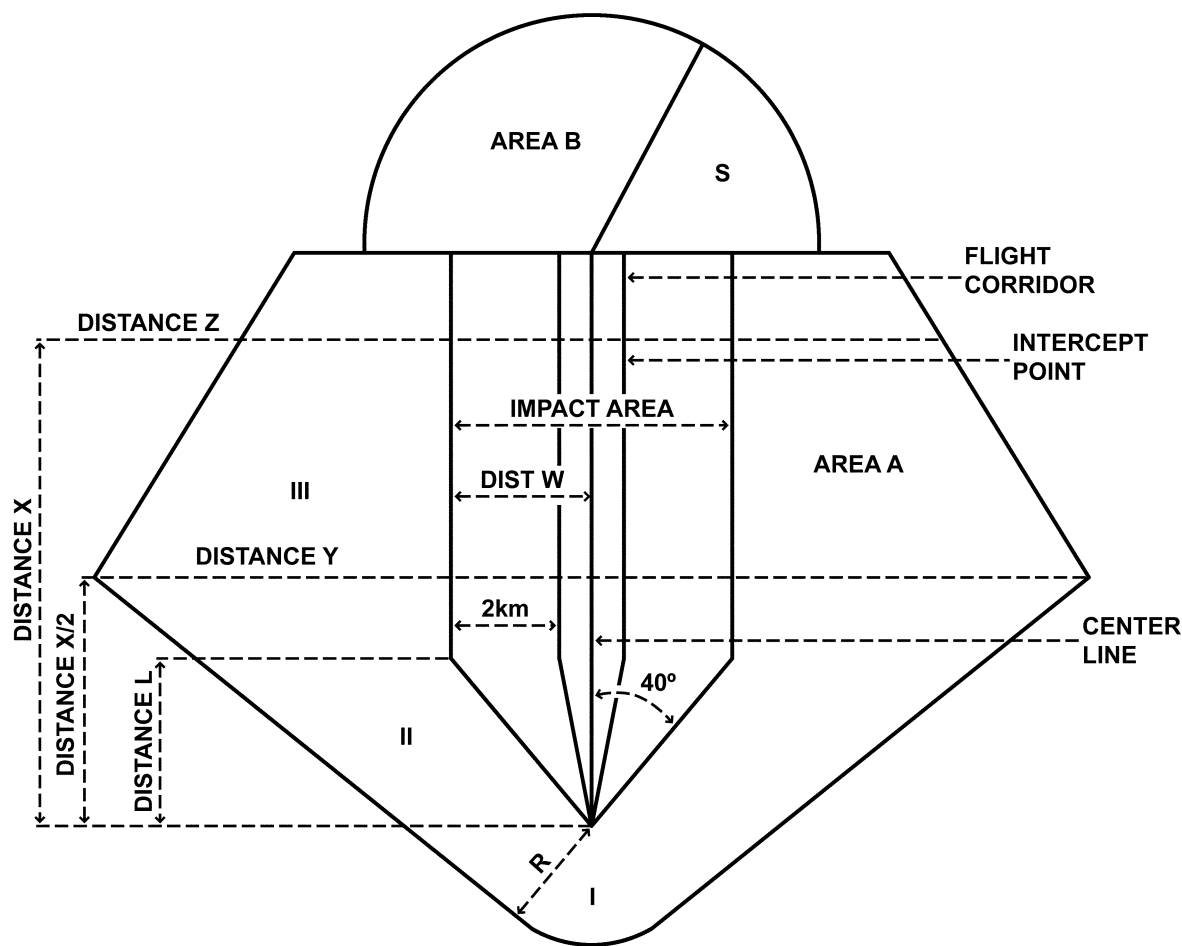

Figure 12-5. Surface danger zone for firing PATRIOT missiles

(2) The impact area is the area on the ground that contains the ground projections of all of the locations where the missile can be destroyed in flight. The boundary of the impact area is defined by the launch dispersion angle (A), the cross-range dispersion (W), and a line normally (90 degrees) to the centerline located 2 km greater than the intercept range. The azimuth dispersion angle (A) is 40 degrees on either side of the centerline. The lines that are drawn at angle A from the launch point intersect cross-range lines drawn parallel to the center line at a downrange distance of L meters from the launch point.

(3) Area A (lateral secondary buffer zone) is the area on the ground that contains debris from a missile that is destroyed on the lateral boundary of the impact area. Action is taken by the trajectory safety officer to initiate the destruction of the missile when the missile intersects the flight corridor boundary. The debris from the missile follows trajectories that are determined by the kinetic, gravitational, wind and aerodynamic forces that act on the debris.

(4) Area B is the area beyond the intercept point that contains the debris from a missile that passes the intercept point without being destroyed by the fuze functioning. The missile is automatically destroyed within 2.2 seconds after passing the target if the missile is not destroyed by the warhead when the fuze functions. The debris from the missile that is destroyed after passing the intercept point impacts the ground within Area B. The automatic termination interval varies and is classified as confidential for MIM-104, MIM-104A, MIM-104B, and MIM-104C, stand off jammer counter.

(5) Distances Y and Z are based upon missile altitude at detonation and speed of cross winds.

12-7. MIM-23B Improved Hawk guided missile (Army)

a. Firing conditions.

(1) The Improved Hawk guided missile SDZ will be cleared of all personnel prior to firing a missile except as authorized below.

(2) The trajectory safety officer must be provided with layouts of the training complex on which the SDZ and trajectory corridor for the particular firing have been defined. The trajectory safety officer must also be provided a means of accurately tracking and plotting the course of a missile during trajectory. Firings normally will be made to a moving aerial target rather than a point in space. In this case, a composite SDZ, which is based on the two extreme azimuth intercept points, will be required. Target azimuth, target elevation, and target velocity will establish the intercept locus (path of moving intercept points). Control of the time interval for launch will establish boundaries for the intercept locus. Figures 12-6 and 12-7 can be used for developing a composite SDZ. Dimensions for Area B will be as shown in table 12-1. Distance X will be based upon the maximum altitude for the predicted intercept point as given in table 12-1. Maximum range for predicted intercept point will establish the inner boundary for Area B. Distance W must be maintained between the "predicted intercept point" and Area B.

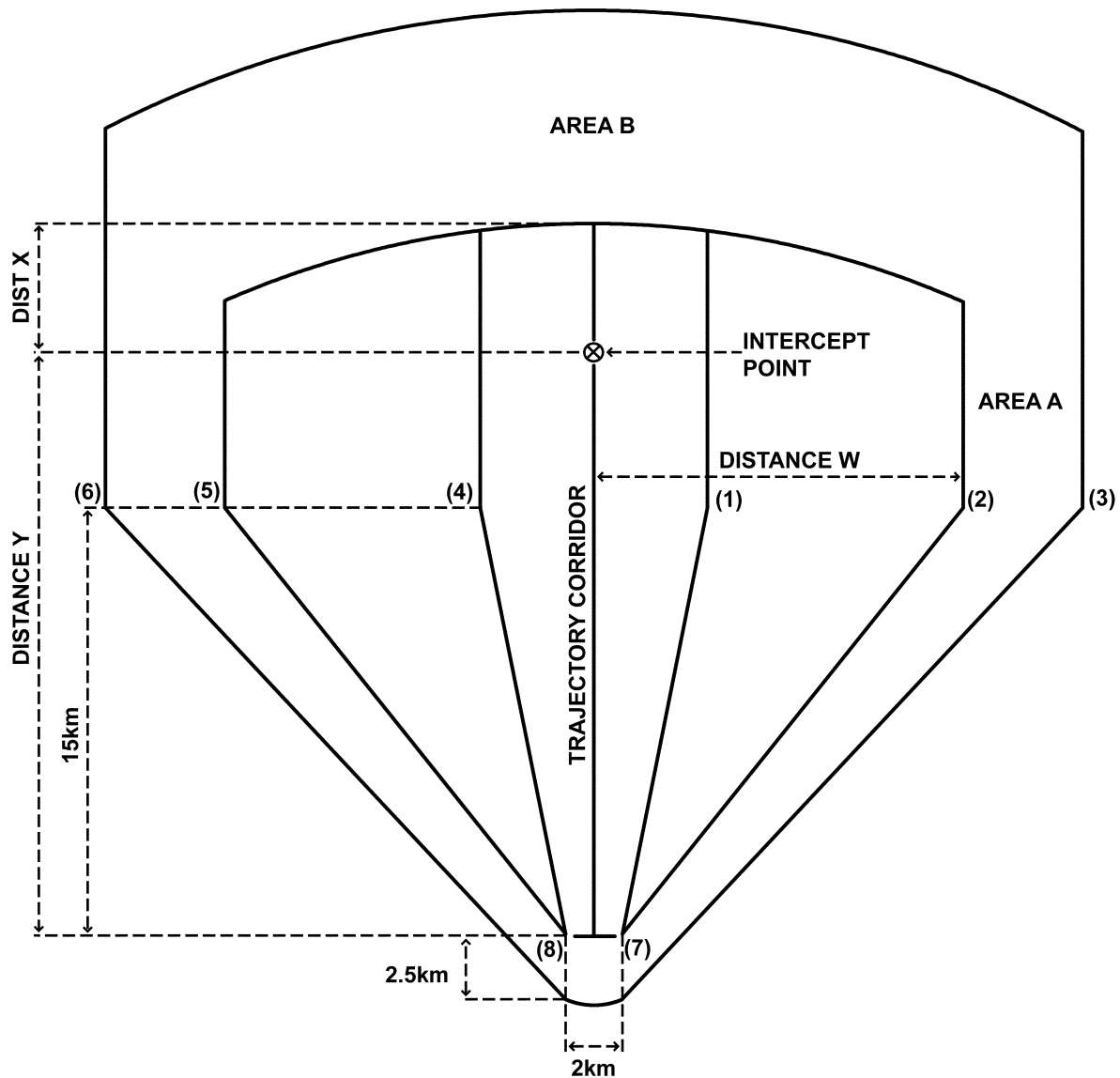

Figure 12-6. Surface danger zone for Improved Hawk guided missile firing at a point in space

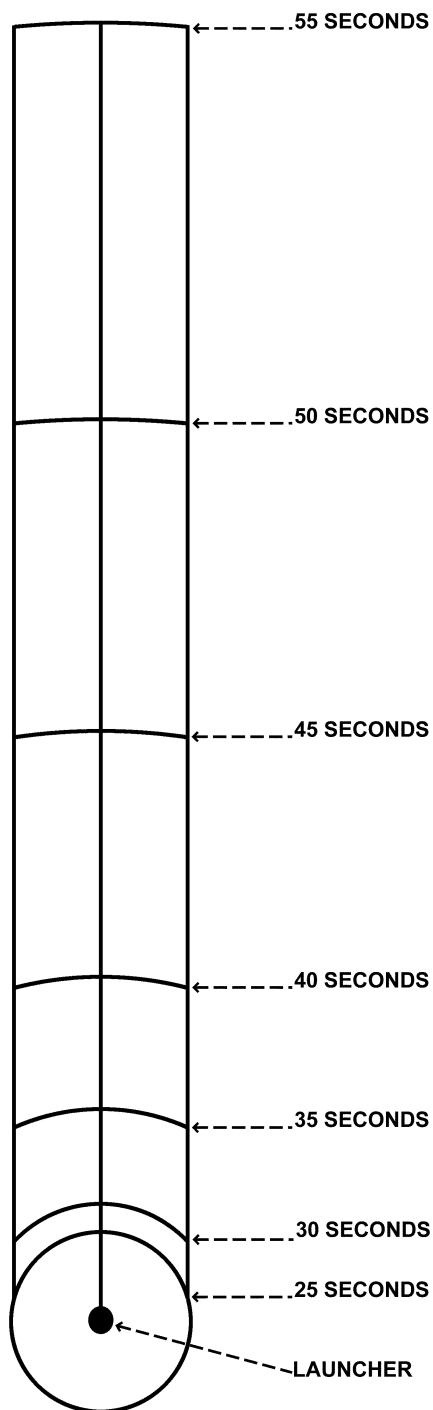

Figure 12-7. Typical trajectory corridor

(3) Only those personnel actively engaged in firing and control of the missile as specified by appropriate TMs and FMs will be permitted in the SDZ at the time of missile firing. The number of personnel thus engaged should be held to an absolute minimum compatible with efficient operation. These personnel should, when possible, occupy appropriate protective shelters that have been located a minimum distance of 61 m from the launcher and constructed in accordance with approved USACE drawings.

(4) Danger areas for debris from target drones which have normal flight paths should be contained within the impact area for the Improved Hawk missile. Areas of impact for target drones which have abnormal flights or which go out of control are not prescribed.

b. Surface danger zone.

(1) SDZ requirements for the Improved Hawk guided missile are given in table 12-1 and figure 12-6 that consists of an impact area and Areas A and B. This SDZ is constructed on the basis that the trajectory safety officer may accomplish actual destruction of the missile after 8.5 seconds from the time of firing or 5.5 seconds after leaving the trajectory corridor. The labels for the SDZ areas below are unique to the Improved Hawk guided missile.

(2) Impact areas are considered adequate to contain the debris from missiles and the impact of missiles that have a normal flight. Trajectory corridor dimensions (W) include the maximum lateral displacement of the missile due to lead angles and maneuvers associated with intercepting a moving aerial target. The area extends 2,500 m to the rear of and to either side of the firing point and opens to a varying Distance (W) at 15,000 m downrange in the direction of fire to either side of the direction of fire depending on the altitude of the intercept (see table 12-1). This area is continued to a Distance (X) meters beyond the intercept point and to a Distance (Y) or (W), whichever is larger, to either side of the predicted intercept point (see table 12-1). The resulting area is considered adequate for firings to a point in space within the trajectory corridor. Range (Distance Y) will be the predicted point of ground impact or target intercept and may vary between minimum intercept and maximum ground impact range capability of the missile if the missile can be destroyed upon departure from the predetermined trajectory path by employing techniques which will reliably predict "range to go." Distance X must be equal to the maximum ground impact range capability of the missile only when trajectory corridors do not provide for destructive points to control the range as well as azimuth of the missile.

(3) Area A is an area 4,200 m wide paralleling the lateral edge of the impact area. This area is normally adequate to contain the debris from missile intercepts, missiles destroyed in trajectory corridors, and the impact of missiles that have an abnormal flight or go out of control and must be destroyed by the trajectory safety officer. Range area to the rear of the firing point is adequate when early prediction of missile trajectory and destruction of the missile can be accomplished in the event the missile is heading in the direction opposite the planned trajectory. The 4,200 m width of Area A is based on the use of trajectory corridors. If trajectory corridors are not used, the width of Area A must be increased to 6500 m to provide time for the trajectory safety officer to recognize abnormal trajectory characteristics and destroy the missile.

(4) Area B is an area 7,500 m wide and is an extension of the impact area and Area A in the direction of fire.

(5) Area F is defined as the area within 61 m of the launcher that is endangered at the time of launch. Hazards are hot rocket exhaust and high velocity aggregate.

(6) The Improved Hawk guided missile SDZ is constructed in the following manner:

(a) Lay out the target flight path on a map or scaled drawing of the firing range. Mark the minimum and maximum intercept points on the target flight path. The two lines joining the intercept points with the launcher define the minimum and maximum firing azimuths. Alternatively the minimum and maximum firing azimuths define the appropriate intercept points.

(b) At a range of 15 km from the launcher, draw lines perpendicular to the firing azimuths.

(c) Along the line perpendicular to the maximum firing azimuth in the direction of increasing azimuth, mark point (1) at 4,000 m (trajectory corridor width), point (2) at the Distance W (maximum debris distance from table 12-1 as determined by intercept altitude), and point (3) at the distance of W plus 4,200 m (the outer boundary of the lateral secondary danger area, Area A).

(d) Similarly, along the line perpendicular to the minimum firing azimuth in the direction of decreasing azimuth, mark the points (4), (5), and (6) at 4,000 m, the Distance W, and the Distance W plus 4,200 m respectively.

(e) Draw lines in the downrange direction from points (1), (2), and (3) parallel to the maximum firing azimuth and from points (4), (5), and (6) parallel to the minimum firing azimuth.

(f) At the firing section draw lines perpendicular to the firing azimuths. Along the line perpendicular to the maximum firing azimuth in the direction of increasing azimuth, mark point (7) at a distance of 1,000 m. Connect point (7) with points (1) and (2) with straight lines. Along the line perpendicular to the minimum firing azimuth in the direction of decreasing azimuth, mark point (8) at a distance of 1,000 m. Connect point (8) with points (4) and (5) with straight lines.

(g) Draw a semicircle with center at the firing section with a radius of 2,500 m to the rear of the firing section.

(h) Draw straight lines tangent to the semicircle to points (3) and (6).

(i) With the firing section as the center, draw the arc of a circle with a radius equal to the sum of the maximum intercept range and the Distance X from table 12–1 as determined by intercept altitude to intersect the lines defining the trajectory corridor, the primary danger area, and the lateral secondary danger area. This arc defines the maximum range boundary of the primary danger area.

(j) With the firing section as the center, draw the arc of a circle with a radius equal to Distance X, plus 7,500 m (the width of Area B) intersecting the lines defining the outer boundaries of the lateral secondary danger area. This arc defines the boundary of the maximum secondary danger area (Area B).

(k) If the intercept range is less than 16 km, the inner boundary of Area A is the Distance W from the intercept point and the width of Area A is 4,200 m at that range. All other procedures listed above apply.

12–8. Trajectory corridor

Trajectory corridors are constructed by scribing concentric semicircles indicating the position of missiles for various times of trajectory (see fig 12–7). By computing range-to-impact on ballistic trajectories for destruct times corresponding to time intervals for selected range positions, it is possible to establish destruction points which will ensure that missiles impact within respective impact areas. By calculating an angle of trajectory that is required to place a missile on the limits of a known impact area for each side of the line of firing, points may be fixed on the range time semicircles, both to the left and right of the line of fire, indicating the position at which the missile must be destroyed if impact is to be within the impact area. By connecting these points with a solid line, the trajectory corridor may be established for the training complex or range. Missiles will not be permitted to go beyond the limits of the trajectory corridor.

Table 12–1
Improved Hawk corridor dimensions

Predicted intercept altitude (ft AGL)	Distance W (m)	Distance X (m)	Trajectory corridor (m)
Ground level	4,600	610	4,000
10,000	6,000	2,000	4,000
20,000	7,400	3,400	4,000
30,000	8,700	4,700	4,000
40,000	10,200	6,200	4,000
50,000	11,700	7,700	4,000

Chapter 13

Chemical Agents and Smoke

13–1. Chemical agents

The use of lethal or incapacitating chemical agents in training is not authorized. Chemical agent use must be addressed case-by-case in special safety analyses. The exception is the Chemical Decontamination Training Facility, Fort Leonard Wood, MO, where training regularly involves live chemical agents.

13–2. Riot control agents

a. Except when prohibited by regulations or higher authority, commanders may use riot control agents (RCAs) in training, subject to the following:

(1) Use of RCAs in training is limited to 0–CS. All other RCAs are prohibited for training use.

(2) Use of RCAs in training requires supervision by personnel specially trained in field behavior, individual protection, and first aid for RCAs. Army personnel that meet these criteria are chemical officers (branch code 74), chemical NCOs (MOS 54B), school-trained chemical, biological, radiological, and nuclear (CBRN) officers (SSI 3R) and NCOs (SQI C). Marine Corps personnel that meet these requirements are MOS 5702 CBRN systems defense officer, and MOS 5711, CBRN defense specialist.

(3) RCAs will not be used under conditions that are dangerous to life or property. Minimum safe distances to heavily traveled installation roads, railroad right of ways, airfields (including all aircraft landing areas), or inhabited areas are:

(a) CS chambers will be at least 100 m away from heavily traveled roads, 500 m from aircraft operations and inhabited areas, and 1,000 m from the nearest installation boundary unless the CS chambers are designed to contain and filter all CS gas.

(b) Field training exercises involving RCAs will be 500 m or more away from public traffic routes, the nearest inhabited buildings, and 1,000 m from installation boundaries.

(4) Prior to a scheduled RCA exercise, training supervisors must conduct a readiness evaluation of personnel. Before being exposed to RCAs, all personnel with respiratory ailments, recent eye surgery, or eye infections, open wounds, severe facial acne, or any active dermatitis, and pregnant personnel must be referred to a medical officer for evaluation. The medical officer will evaluate the health records of these individuals and, when necessary, examine the personnel to determine their readiness to undergo training without undue medical risk. The examination results (stating can/cannot participate in training with RCAs only) will be documented in the personnel medical records.

(5) OICs and RSOs must ensure protective masks are available for all personnel participating in training.

(6) When CBRN protective equipment is worn, the OIC/RSO will consider the additional heat stress placed on personnel. When using the wet-bulb globe temperature to determine the heat category, add 10 degrees Fahrenheit if personnel are in body armor and mission-oriented protective posture (MOPP) level two through four. High ambient temperatures, high humidity, and heavy workload are factors that increase the potential for heat injuries. To reduce the heat stress risk, commanders will —

(a) Provide an ample water supply and encourage all personnel to drink plenty of water. OICs and RSOs will monitor personnel undergoing training to ensure personnel frequently drink water to replace lost fluids.

(b) Reduce the MOPP level under high heat stress conditions when possible.

(c) Schedule additional rest breaks during training to allow personnel to cool off. These periods also can be used for critiques. Where possible, use vehicles to move personnel who are wearing protective equipment.

(d) Ensure subordinate commanders and leaders check their personnel for early signs of heat stress. Authorize frequent breaks while operating in protective equipment.

(7) Wearing of contact lenses while masked is not authorized. Personnel who wear contact lenses must remove them and use standard prescription eyeglasses during chemical defense training that includes wearing the protective mask. Unnecessary eye irritation will occur if RCA particles are trapped under contact lenses. All individuals requiring corrective lenses must have masks with correctly fitted optical inserts.

(8) Unprotected personnel will not be exposed to RCAs longer than 15 seconds.

b. Personnel specified in paragraph a(2) will supervise the mask confidence course.

c. Employment conditions.

(1) CS will be used in training only under the supervision of an officer/staff noncommissioned officer/NCO who has received formal training in the characteristics, capabilities, and training applications of these agents.

(2) Only CS in capsule form may be used in the CS chamber.

(3) For the Marine Corps, when CS is used in outdoor confidence courses, the RSO must have been trained in the CS chamber within the past year. The use of a 5702 CBRN defense officer and 5711 CBRN defense specialist is not required.

(4) RCAs will not be released when personnel without proper respiratory protective equipment located downwind will be affected, unless exposure to a controlled concentration is desired. CS agents will not be released within 50 m of spectators.

(5) Marine Corps personnel handling or dispensing CS capsules will wear MOPP level four.

(6) Army personnel handling or dispensing CS capsules will wear rubber boots, protective mask with hood, and field clothing secured at neck, wrists, and ankles.

(7) Individuals affected by RCAs will move to fresh air and face into the wind for 5 to 10 minutes, avoid rubbing the eyes, and remain well-spaced from other affected personnel. If accidentally exposed to an RCA, clothing will be removed from the affected skin as soon as possible. Flush the exposed area(s) with large volumes of cool water for not less than 15 minutes, and then seek prompt medical attention. If available, mild soap should be used to cleanse the contaminated skin.

(8) Hot water should not be used when showering as it will raise the vapor point of the CS, resulting in further spreading of contamination.

(9) When eyes are contaminated with a CS agent, treat them with a 1 percent solution of sodium bicarbonate (baking soda). If not available, hold the eyes open with fingers, flush with water for not fewer than 15 minutes, then seek medical attention.

(10) Contaminated clothing will be removed from the area to prevent accidental contamination of unprotected personnel.

d. When RCAs are transported in Army or Marine Corps aircraft, compliance with AR 95–1, AR 95–27, MCO 4030.25B, and MCO 4030.40B is required.

e. For the Marine Corps, the following are requirements for all CS exercises, whether garrison or field training:

(1) Corpsman or medic with unit 5 medic bag.

(2) Designated safety vehicle with a driver who will not be in the chamber, but will have a protective mask on hand.

(3) Instructors will be easily/readily identifiable while in the CS chamber.

13-3. Smoke

The use of smoke in training poses special health and safety issues. The following precautions apply to all smoke training with fog oil, hexachloroethane (HC), red phosphorus, WP, plasticized WP, terephthalic acid (TA), and colored and diesel smokes.

a. Personnel will carry a protective mask when participating in exercises that include the use of smoke. Personnel will mask —

(1) Before exposure to any concentration of smoke produced by M8 white smoke grenades, M83 smoke grenades (TA), smoke pots (HC and TA smoke), or metallic powder obscurants.

(2) When passing through or operating in dense (visibility less than 50 m) smoke such as smoke blankets and smoke curtains.

(3) When operating in or passing through a smoke haze (visibility greater than 50 m) and the duration of exposure will exceed 4 hours.

(4) Any time exposure to smoke produces breathing difficulty, eye irritation or discomfort. Such effects in one individual will serve as a signal for all similarly exposed personnel to mask.

(5) When using smoke during military operations in urban terrain training or when operating in enclosed spaces. The protective mask is not effective in oxygen-deficient atmospheres. Care must be taken not to enter areas where oxygen may have been displaced.

b. Clothing is to be laundered and personnel will shower after exercises involving exposure to smoke. Personnel exposed to smoke should reduce skin exposure by rolling down their sleeves.

c. Special care must be taken when using HC and TA smoke to ensure that appropriate protection is provided to all personnel who may be exposed. When planning for the use of HC smoke in training, consideration must be given to weather conditions and the potential downwind effects of the smoke. Positive controls, (observation, control points, communications) must be established to prevent exposure of unprotected personnel. Detailed hazard information is available on the appropriate safety data sheet(s).

d. FS (sulfur trioxide-chlorosulfonic acid solution) and FM (titanium tetrachloride) smoke will not be used in training.

e. Smoke will not be used in public demonstrations, displays, or ceremonies unless positive dissipation of the smoke can be assured and no exposure to the public or nonparticipating personnel is expected. A risk management plan will be developed by the agency conducting the public demonstration, in conjunction with the installation RMA (Army), RCO (Marine Corps) and safety director, for all uses of smoke in demonstrations, displays, or ceremonies.

13-4. Smoke pots

a. Personnel manually firing HC and TA smoke pots will mask and keep their head well to one side to the top of the pot and out of the way of sparks and flames to prevent burn injuries. Once HC and TA smoke pots have ignited, personnel will quickly move away a minimum distance of 30 m.

b. Precautions will be taken to prevent ground fires. HC and TA smoke pots will not be fired inside buildings, tents, or other enclosed areas because of fire and health hazards from associated fumes. Exceptions are building or structures specially designed for smoke training, and only after conducting a thorough risk assessment, developing and implementing controls, and acceptance of the residual risk by the appropriate commander.

c. HC and TA smoke pots must be kept dry. Any addition of water to HC and TA smoke mixtures may cause it to burn erratically, explode, or result in spontaneous combustion. HC smoke pots will not be ignited during visible precipitation (snow or rain).

d. The M4A2 smoke pot must be vented for at least 5 minutes within 24 hours before use in accordance with TB 3-1365-490-10.

e. When electrically firing the M5 HC smoke pot, at least 30 m of WD-1/TT wire will be used.

13-5. Oil smoke candles

Oil smoke candles (M6, SGF2) are used to produce nontoxic smoke in confined areas primarily to simulate fires in buildings or ships for fire drills and to train firefighters. The correct procedure for use is to place the candle on its base atop a stable platform away from combustible materials, pull the safety pin, and release the safety lever.

Chapter 14

Non-Lethal Weapons

14-1. Definition

Department of Defense Directive (DODD) 3000.03E defines non-lethal weapons (NLWs) as "weapons that are explicitly designed and primarily employed so as to incapacitate personnel or materiel while minimizing fatalities,

permanent injury to personnel, and undesired damage to property and the environment." Furthermore, "unlike conventional lethal weapons that destroy their targets principally through blast, penetration, and fragmentation, NLW employ means other than gross physical destruction to prevent the target from functioning. NLW are intended to have relatively reversible effects on personnel and materiel."

14-2. General

- a. The term "non-lethal" does not mean zero mortality or nonpermanent damage. Fatal injuries can occur if munitions are employed at a distance that is less than the determined minimum safe engagement range.
- b. The Inter-Service Non-Lethal Individual Weapons Instructors Course is the only course in DOD that is certified to produce instructors who will train individuals in the proper employment of NLWs.
- c. For the Marine Corps, the use of NLW in force-on-force scenarios with the exception of SESAMS/CCMCK is authorized only under approved deviation per AR 385-63/MCO 3570.1C and chapter 1 of this pamphlet and operational risk management procedures have been completed in accordance with MCRP 5-12D and MCO 3500.27B.
- d. For the Marine Corps, if force-on-force training with NLW is conducted under an approved deviation, Marines may be in the NLW danger zone but must remain outside the minimum target engagement distance at all times.
- e. For the Army, Soldiers participating in force-on-force training with NLW may be in the NLW SDZ, but must remain outside the minimum engagement distance at all times.
- f. Head shots with NLW are not authorized.

14-3. Surface danger zones

- a. Many non-lethal munitions have both a maximum effective range and minimum target engagement distance. Individuals short of the minimum target engagement distance may suffer severe injuries or death. The effects of most non-lethal munitions are greatly decreased at longer ranges.
- b. Hazardous effects from certain NLW munitions can be experienced at or behind the firing line. For example, the rubber rounds described in paragraph 14-4 may bounce back when fired against a hard surface.
- c. Area R is the portion of the SDZ behind the firer where personnel, equipment, and facilities may be endangered by ricochets to the rear of the firing line.

14-4. 12-gauge shotgun, M1012 (AA51), M1013 (AA52), and bean bag (AA29) projectiles

- a. The M1012 (AA51) projectile is a fin-stabilized projectile made of rubber designed for point targets. The M1013 (AA52) is a ball projectile and consists of 18 polyvinyl chloride rubber compound balls designed for crowds/groups.
- b. For the M1012 (AA51) and M1013 (AA52), minimum engagement is 10 m with a maximum effective range of 20 m.
- c. The tabular data for the M1012 (AA51) and M1013 (AA52) is contained in table 14-1.
- d. The SDZ for M1012 (AA51) and M1013 (AA52) is contained in figure 14-1.
- e. When firing the 12-gauge shotgun with the rubber ball grenade launch cup attached, carbon can build up in the barrel. This carbon build up may create a malfunction if the launcher cup is removed and the 12-gauge bean bag (AA29) rounds are fired. Bean bag rounds may get stuck in the barrel.
- f. Gas operated shotguns may malfunction when shooting nonlethal ammunition. This may result in increased stoppages/malfunctions or require the weapon to be cycled manually.
- g. For the Marine Corps, PPE Level 0 is required.

Table 14-1
Surface danger zone for 12-gauge, hard and soft targets

Nomenclature DODIC	Distance X (m)	Distance Y (m)	Distance W (m)	Area R depth (m)	Area R width (m)	Angle P (deg)	Angle Q (deg)	Dispersion angle (deg)
M1012 (AA51)	500	400	150	50	300	80	35	10
M1013 (AA52)	180	160	75	20	150	75	60	15

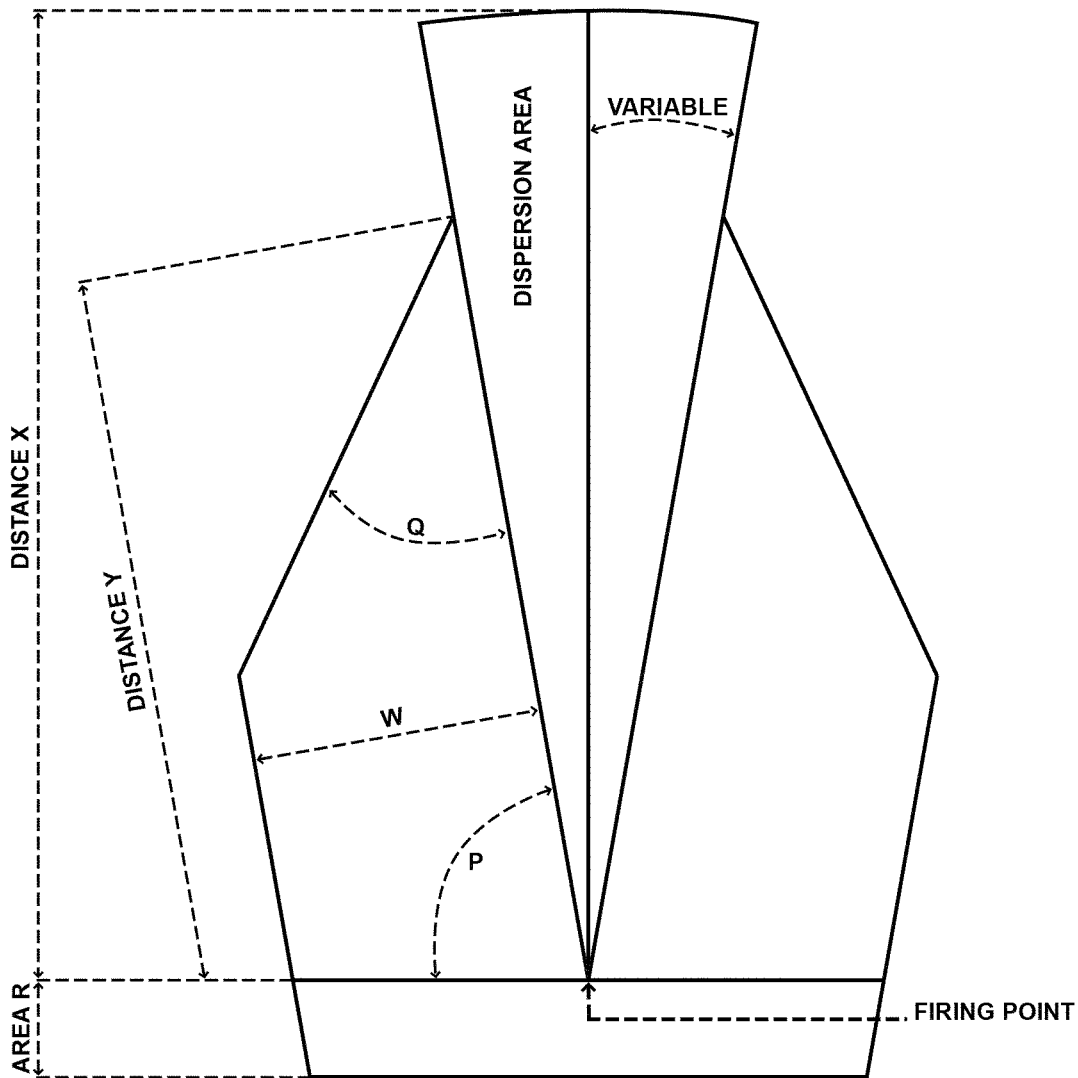

Figure 14-1. Surface danger zone for 12- gauge M1012 (AA51) and M1013 (AA52)

14-5. 40mm M1006 (BA06) sponge grenade

- a. The M1006 (BA06) is a sponge grenade cartridge comprised of a 40mm bullet-shaped foam rubber round.
- b. Minimum engagement for this NLW is 10 m, with a maximum effective range of 20 m.
- c. The tabular data for M1006 is contained in table 14-2.
- d. The SDZ for M1006 is contained in figure 14-2.
- e. The round is most effective against point targets. At distances of 10 m to 50 m, aiming point should be center mass of target.
- f. Do not skip fire this round.
- g. For the Marine Corps, PPE Level 0 is required.

Table 14–2
M1006 (BA06) 40mm sponge grenade

Distance X (m)	Distance Y (m)	Distance W (m)	Area R (m)	Angle P (deg)	Angle Q (deg)
265	190	60	44	82	48

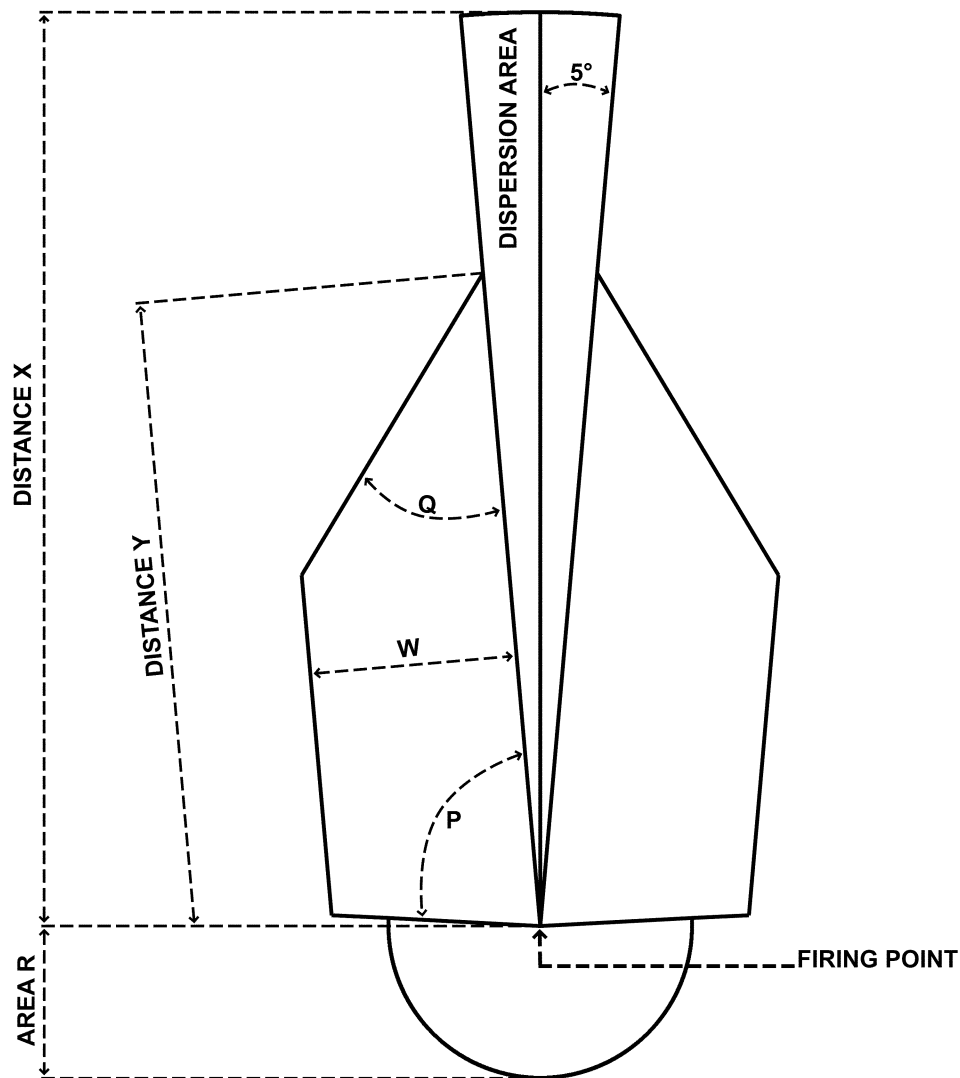

Figure 14–2. Surface danger zone for M1006 (BA06) 40mm sponge grenade

14–6. 40mm grenade foam rubber baton (BA07), rubber ball grenade (BA08), and M1029 (BA13)

a. The BA07 is a foam rubber baton; the BA08 is a rubber ball grenade that will be superseded by the BA13. The M1029 (BA13) is a crowd-dispersal grenade consisting of 48 rubber balls.

b. Minimum engagement range for this NLW is 10 m and the maximum effective range is 30 m.

c. The tabular data for foam rubber baton (BA07), rubber ball grenade (BA08), and M1029 (BA13) is contained in table 14–3.

d. The SDZ is contained in figure 14–3.

e. The width of Area R encompasses Distance W and lateral limits as appropriate. For the 40mm grenade foam rubber baton (BA07), rubber ball grenade (BA08), and M1029 (BA13) Area W width is 57 m to each side of the weapon firing location.

f. At distances of 10 m to 30 m, the aiming point should be center mass of the group of individual targets.

g. For the Marine Corps, PPE Level 0 is required.

Table 14-3
40mm grenade foam rubber baton (BA07), rubber ball grenade (BA08), and M1029 (BA13) grenade

Nomenclature (DODIC)	Distance X (m)	Distance Y (m)	Distance W (m)	Area R depth (m)	Area R width (m)	Angle P (deg)	Angle Q (deg)	Dispersion angle
Rubber baton (BA07)	180	140	55	15	114	75	62	15
Rubber ball (BA08)	180	140	55	15	114	75	62	15
M1029 (BA13)	180	140	55	15	114	75	62	15

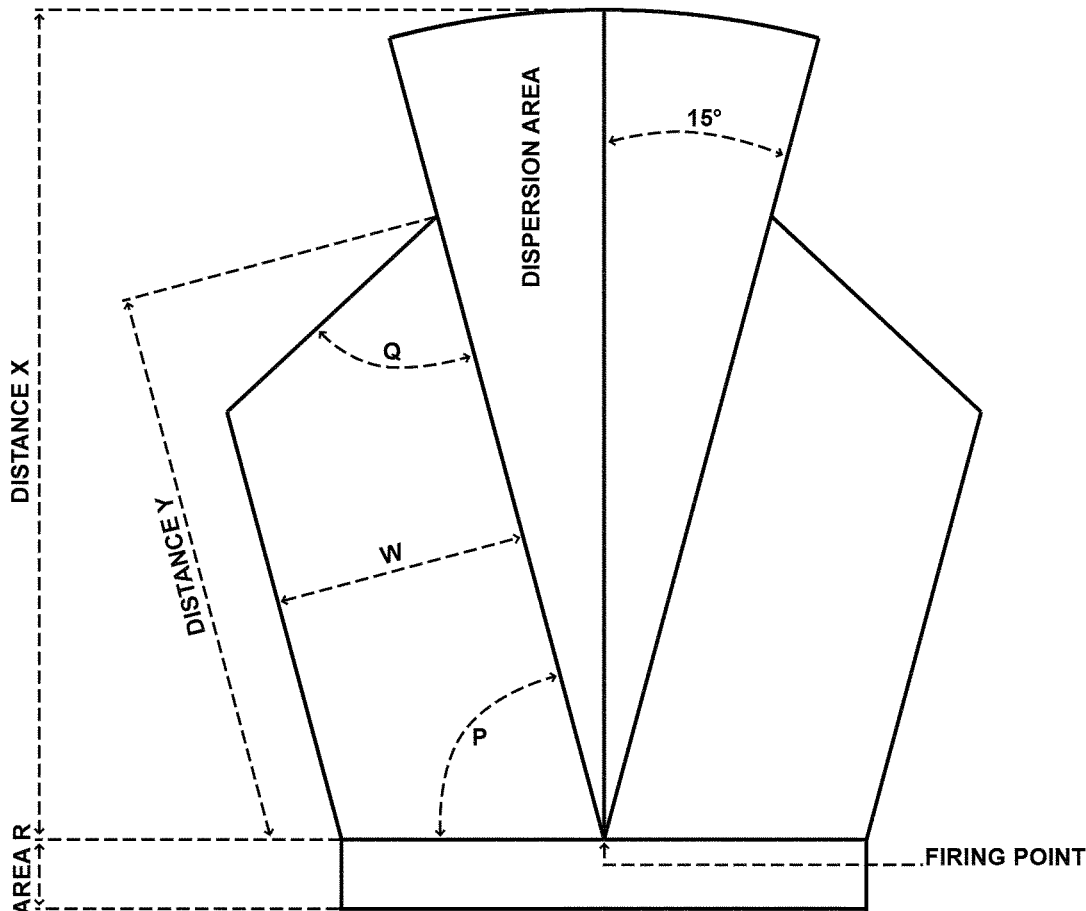

Figure 14-3. Surface danger zone for the 40mm grenade foam rubber baton (BA07), rubber ball grenade (BA08), and M1029 (BA13)

14-7. Rubber ball grenade (GG04)

a. The rubber ball grenade (GG04) has a rubber molded body and consists of 100 rubber balls. The rubber ball grenade (GG04) is both a handheld and 12-gauge shotgun launched non-lethal device and is the only non-lethal munition that can be delivered in defilade. The rubber ball grenade (GG04) is an area target munition.

b. The employment distance for the hand thrown rubber ball grenade (GG04) is 16 m (50 ft). For the shotgun launched rubber ball grenade (GG04), the employment distance is 61 m (200 ft).

c. The minimum safe distance for the rubber ball grenade (GG04) hand thrown grenade is 3 m and has an effective range of 20 m. Debris may also travel out to a distance of 35 m.

d. SDZ data for the hand thrown rubber ball grenade (GG04) is contained in figure 14-4.

e. SDZ data for the shotgun launched rubber ball grenade (GG04) is contained in figure 14-5.

f. When employing these grenades local fire conditions must be considered due to possible fire hazards.

g. For the Marine Corps, PPE Level 0 is required.

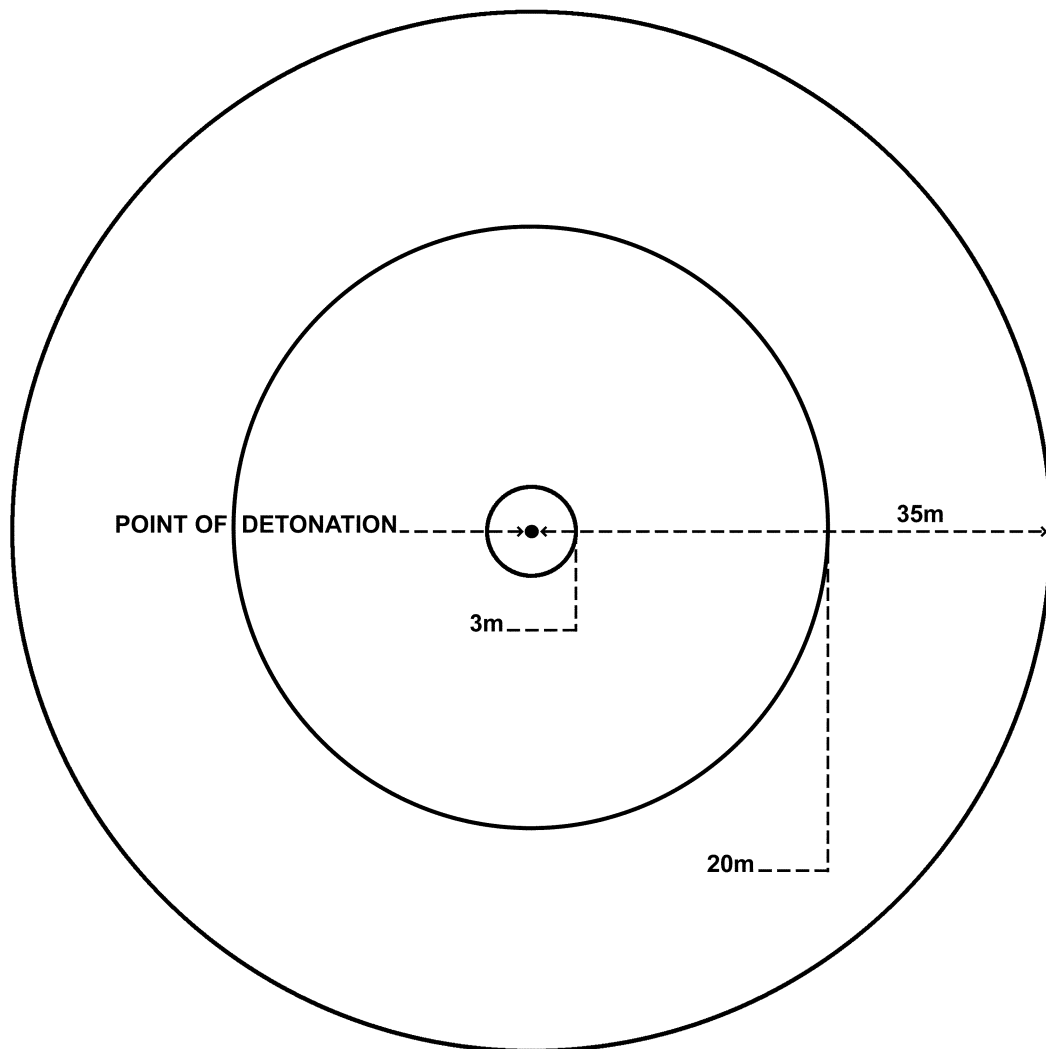

Figure 14-4. Surface danger zone for rubber ball grenade (GG04) (Hand Thrown)

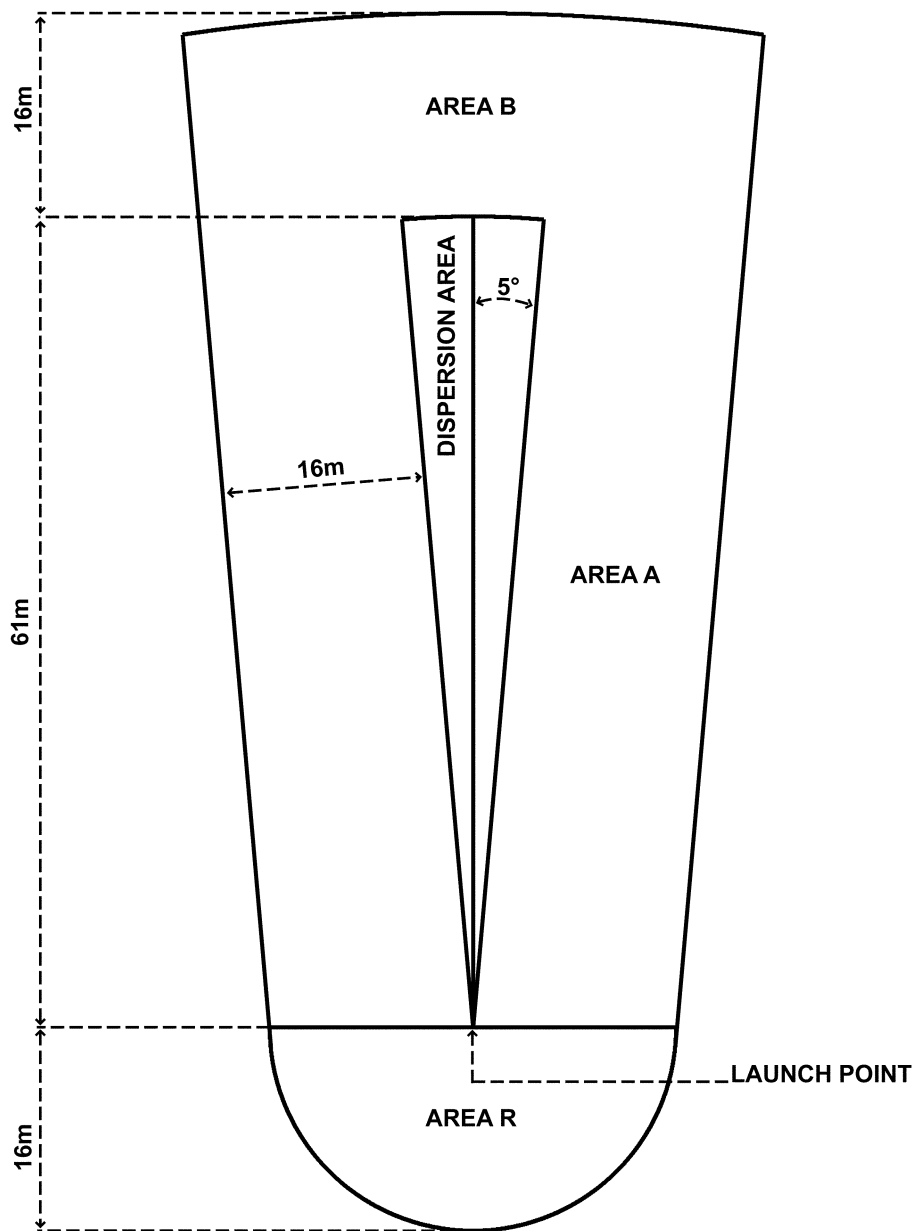

Figure 14-5. Surface danger zone for rubber ball grenade (GG04) (Shotgun Launched Grenade)

14-8. M5 modular crowd control munition (WA97)

- a. The modular crowd control munition (MCCM) (WA97) is a munition which resembles the M18A1 Claymore Mine. The rubber balls are launched in a fan-shaped distribution pattern.
- b. This weapon has a minimum engagement range of 5 m and a maximum effective range of 15 m.
- c. Detonation of the MCCM (WA97) presents a rearward danger zone, Area R.
- d. The SDZ is contained in figure 14-6.
- e. When firing the MCCM (WA97) from vehicles, use mounting systems in accordance with applicable technical manuals. Mount the MCCM (WA97) on armor-hardened vehicles only.
- f. For the Marine Corps, PPE Level 0 is required.

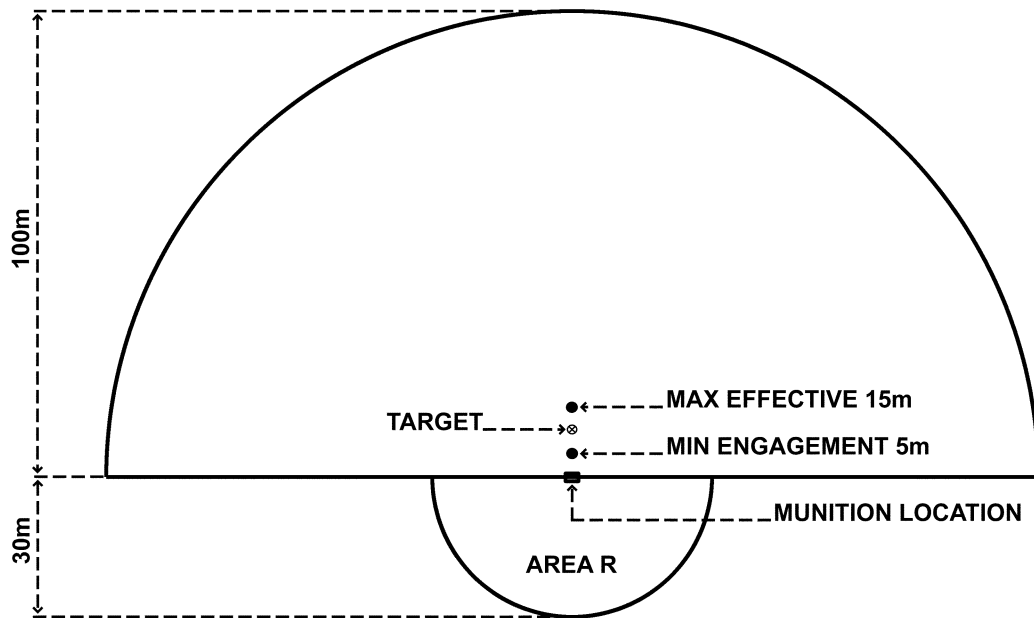

Figure 14-6. Surface danger zone for modular crowd control munition (WA97)

14-9. M84 stun grenade (GG09)

a. The M84 stun grenade (GG09) is a non-lethal diversionary device. It is used to apply the minimum force necessary by tactical and non-tactical forces while performing hostage rescue and capture of adversary missions. Stun grenades may cause fires under certain conditions.

b. The daily exposure limit within the noise hazard contour is as follows:

- (1) Double hearing protection is required when employing 41 rounds or more per day at 2 m.
- (2) Single hearing protection is required when employing 2 rounds or more per day at 2 m.
- (3) Single hearing protection is required when employing 1,000 rounds or more per day at 3 m.
- (4) The SDZ is contained in figure 14-7.

c. For the Marine Corps, PPE Level 0 is required.

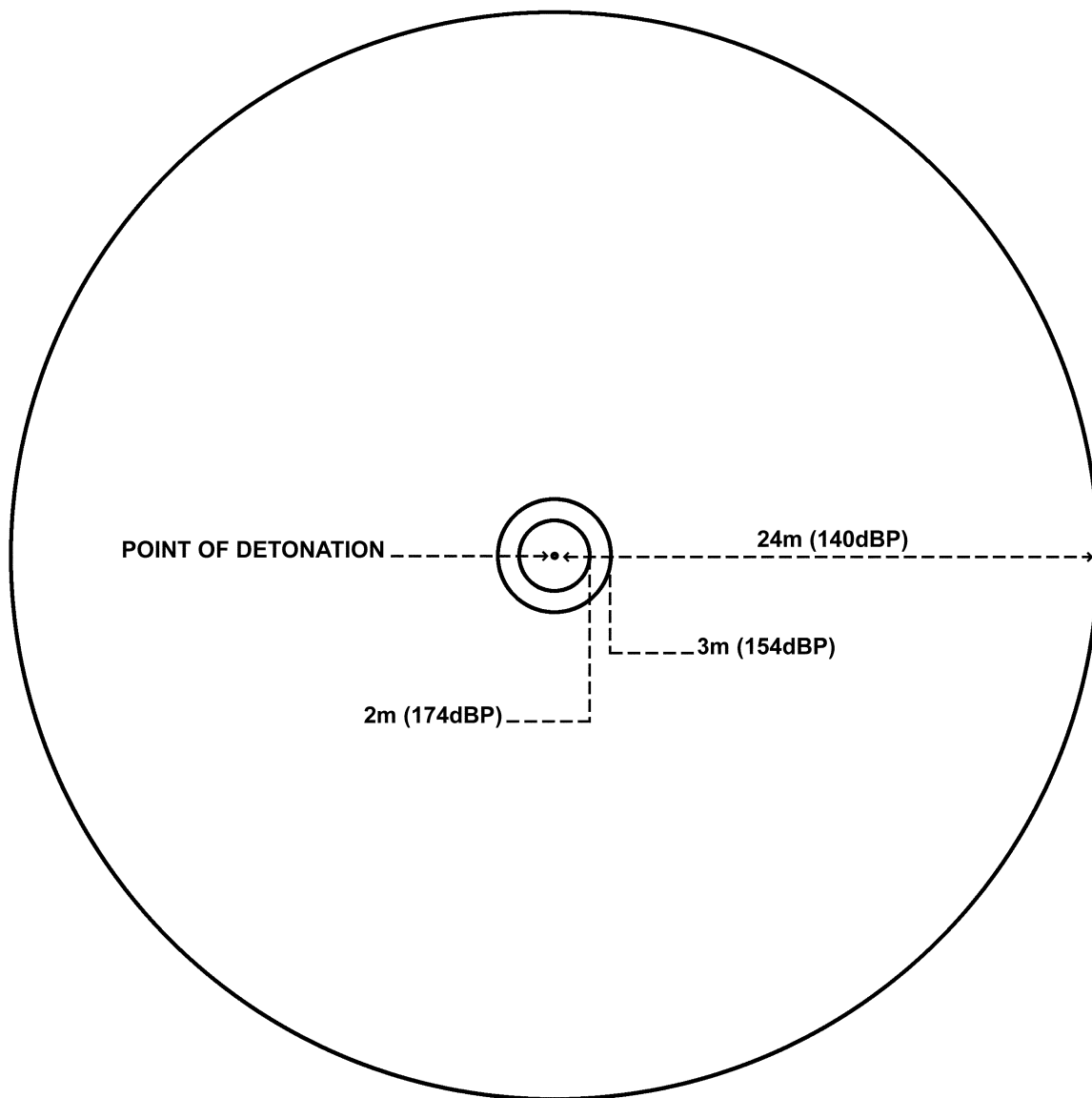

Figure 14-7. Surface danger zone for M84 stun grenade (GG09)

14-10. M98 (FZ16) and M99 (FZ17) 66mm non-lethal grenade

- a. The M98 (FZ16) and M99 (FZ17) 66mm non-lethal grenades are launched from vehicle-mounted tubes. The grenades are packaged three-to-a-tube.
- b. The non-lethal grenade M98 (FZ16) is a distraction grenade with a flash and a loud report shortly after impact.
- c. The non-lethal grenade M99 (FZ17) is a blunt-trauma grenade that functions with a similar flash/bang followed by the discharge of approximately 420 plastic balls (140 per canister).
- d. The SDZ is contained in figure 14-8. The tabular data for these grenades are contained in table 14-4.
- e. For the Marine Corps, PPE Level 0 is required.

Table 14-4
Surface danger zone parameters for the 66mm M98 and M99 Grenades

Distance X (m)	Distance Y (m)	Area W (m)	Area A (m)	Area B (m)	Area R (m)	Angle P (deg)
210	75	40	10	10	10	28.07

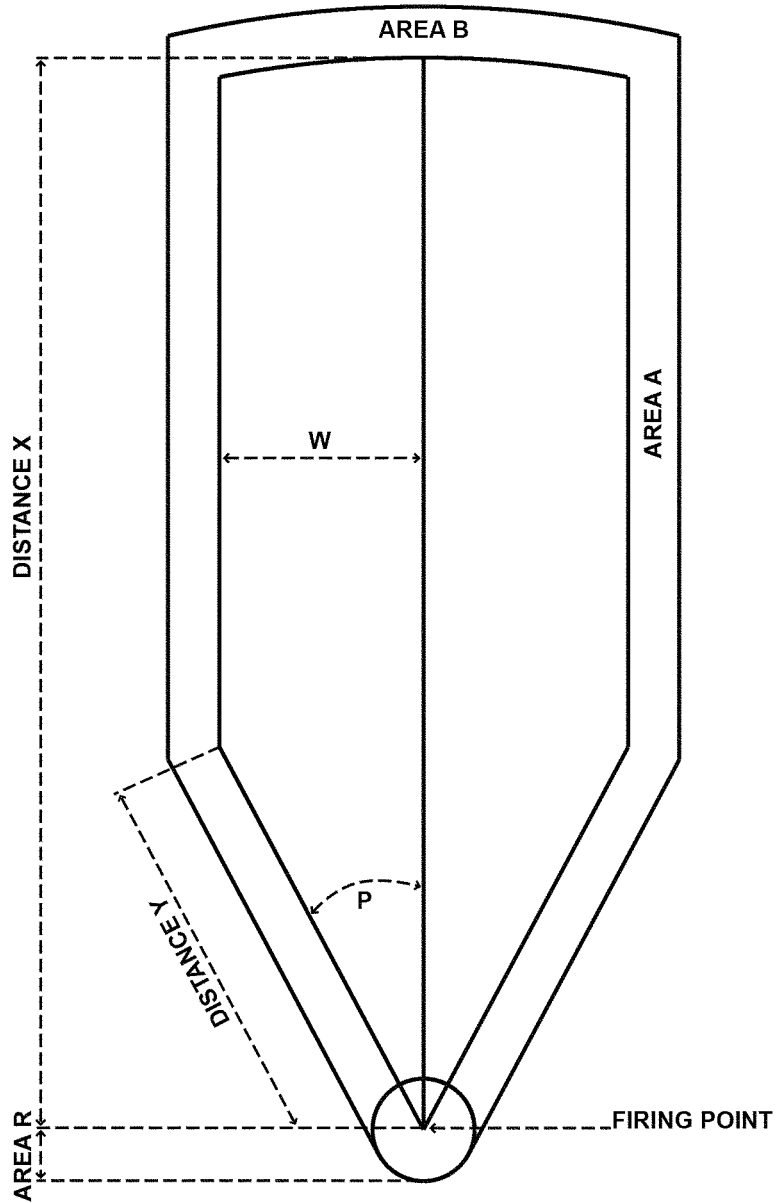

Figure 14-8. Surface danger zone for M98 (FZ16), and M99 (FZ17) 66mm non-lethal grenade

14-11. Launched electrode stun device

a. The device is used to propel wire probes which conduct energy to affect the sensory and motor functions of the nervous system. The launched electrode stun device provides the capability for non-lethal incapacitation of an individual at close range.

b. The two probes are propelled by compressed gas and are connected to the weapon by 25 or 35ft long high voltage insulated wires.

c. The SDZ is contained in figure 14-9.

d. For the Marine Corps, PPE Level 0 is required.

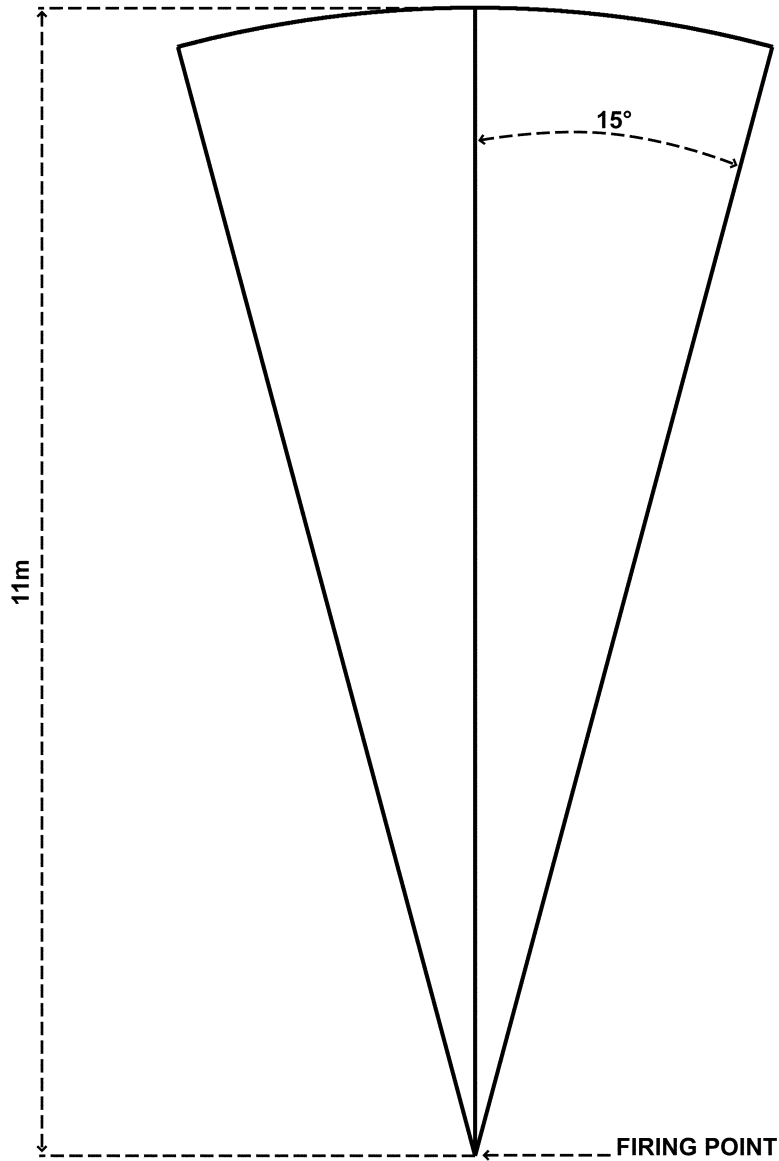

Figure 14-9. Launched electrode stun device

14-12. M104 non-lethal bursting hand grenade

- a. The M104 non-lethal bursting hand grenade has a rubber molded body and has an output that combines a bright flash and loud explosion which consists of 100 pliable rubber projectiles to disorient and confuse targeted personnel.
- b. PPE including eye and neck protection (Army) is required within a 17 m radius. For the Marine Corps, PPE Level 0 is required.
- c. Single hearing protection is required by all personnel within 195 m.
- d. The SDZ is contained in figure 14-10.

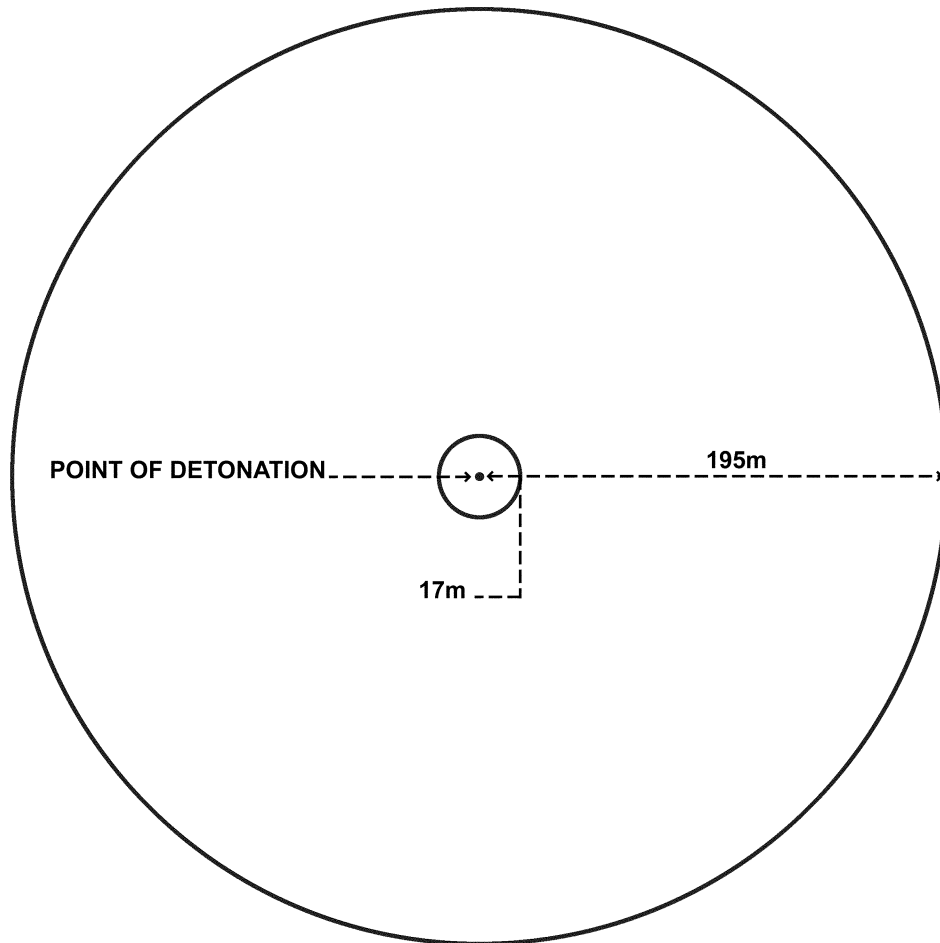

Figure 14-10. Surface danger zone for the non-lethal bursting hand grenade (M104)

14-13. Non-lethal/tube launched munition system

- a. The non-lethal/tube launched munition system (NL/TLMS) is a vehicle or ground-mounted, multi-shot, electrically actuated, non-lethal munitions grenade launcher. The system is a non-lethal addition to the force protection toolset. It provides the user with a non-lethal means of determining potential hostile intent at sufficient stand-off distance. It is composed of a 40mm multi-flash bang cartridge, launcher, and a family of bracket kits. The NL/TLMS will be fired into dedicated impact areas only.
- b. The NL/TLMS may be mounted on the Gunner's Protective Kit, Objective-Gunner's Protective Kit or the Marine Corps Transparent Armor Gun Shield. The NL/TLMS may also be ground-mounted on an M3 machine gun tripod. When vehicle-mounted, the NL/TLMS is co-axially mounted with either the M2 .50 caliber machine gun, MK19 40mm machine gun, or the M240G machine gun. The use of the Marine Corps Transparent Armor Gun Shield with the NL/TLMS installed in an extended position is prohibited until an upgraded universal pintle and base frame bracket assembly is incorporated.

(1) In the extended configuration (pushed forward of the gunner position), a vibration hazard exists which creates the possibility of damage to the base frame.

(2) When used in the retracted configuration (pulled towards the gunner), the use of the M2 .50 caliber machine gun and MK19 40mm grenade launcher is prohibited due to lack of space to mount the ammunition canisters.

c. Table 14–5 below provides the frequency bands, maximum allowable environment (MAE) expressed in volts per meter (V/m), and S4 phases of NL/TLMS operation. It indicates the electromagnetic radiation to which the NL/TLMS may safely be exposed without a potential premature ignition of the munition.

Table 14–5
Non-lethal/tube launched munition system maximum allowable environment

Frequency (megahertz (MHz))	MAE (V/m)	S4 phases
2–32	15	Handling and loading
400–700	14.1	Handling and loading
700–790	36.3	Handling and loading
790–1,000	46.9	Handling and loading
790–1,000	387	Handling and loading staged, or platform loaded

d. Minimum safe target engagement for the NL/TLMS is 31 m due to possibility of fragments or debris. Additionally, the stand-off distance will be 31 m for known transmitters such as the AN/VRC–104, Counter Radio-Controlled Improvised Explosive Device Electronic Warfare (CREW), CREW-training, and electronically fuzed counter-improvised explosive device systems during handling and loading phases of the NL/TLMS.

e. All personnel will wear eye protection, single-hearing protection, and throat protector provided for the modular tactical vest. While the NL/TLMS is being fired from the vehicle platform, firing personnel will be fully seated in the turret using the turret harness.

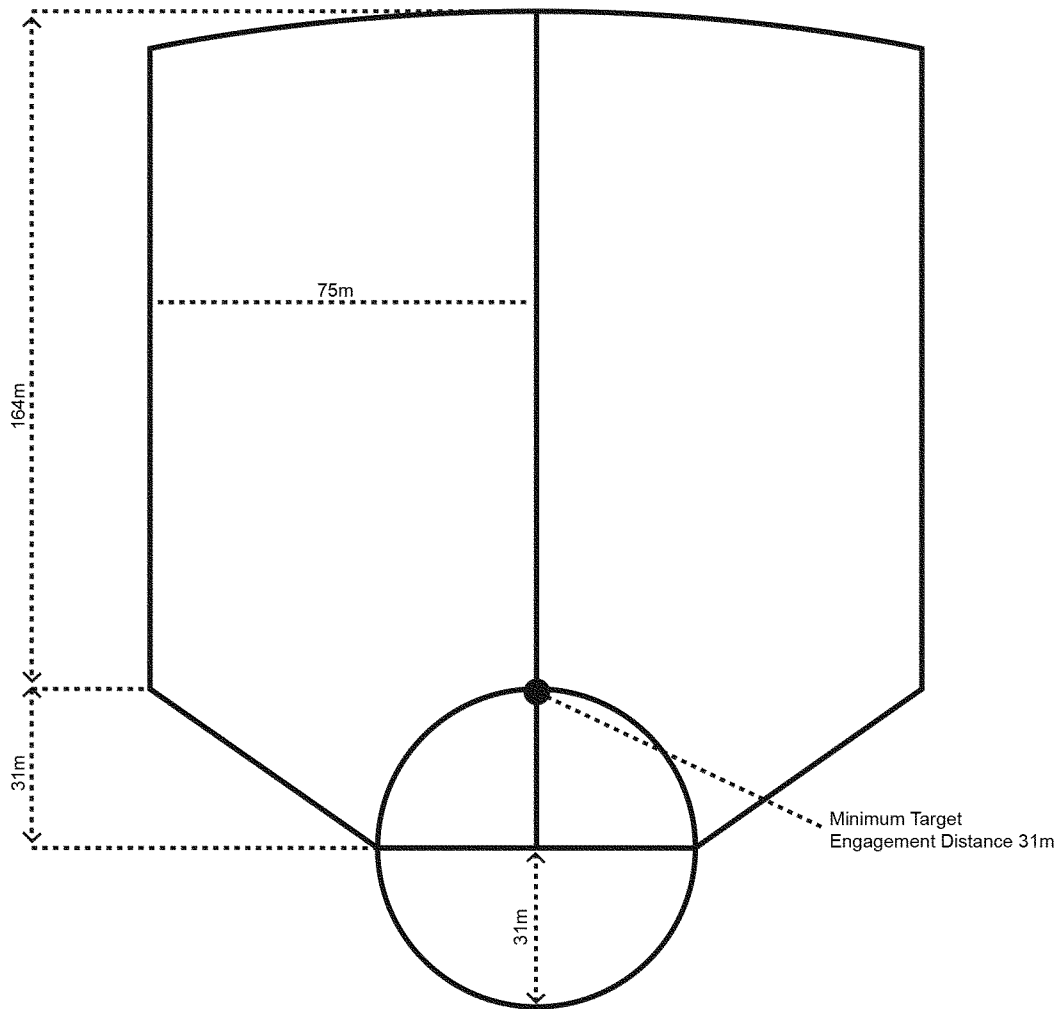

Figure 14–11. Surface danger zone for the non-lethal/tube launched munition system

14–14. Special Effects Small Arms Marking System (Marine Corps)

a. The Special Effects Small Arms Marking System (SESAMS) is a Marine Corps training system that fires a marking cartridge (colored dye) to enhance realism for force-on-force training. Improper use of the SESAMS training system may cause serious personal injury and/or damage to equipment.

b. The mixing of live ammunition and SESAMS rounds is prohibited.

c. Installation commanders should establish a RSO program that specifically addresses SESAMS training system requirements. SESAMS training systems will also be addressed in the installation's range SOP.

d. Upon completion of the SESAMS RSO requirements, installation commanders will certify Marine staff sergeants (and above), or other Service equivalent, as SESAMS RSO.

e. Before SESAMS firing:

(1) Ensure that only Marine Corps procured adapter kits and marking cartridges are used.

(2) Force-on-force training with SESAMS 9mm DODICs (AA12) and (AA21) is prohibited when temperatures are below 38 degrees Fahrenheit. Training with SESAMS 5.56mm DODICs (AB05) and (AB06) is prohibited when temperatures are below 18 degrees or above 104 degrees Fahrenheit.

(3) Account for and remove all live ammunition from the designated training area prior to commencement of SESAMS training exercises.

(4) Instruct all participants that head shots are not authorized.

(5) Ensure that all personnel within the 150 m safety distance (zone) wear PPE Level 0 protective equipment and clothing. The use of groin protection and gloves is highly encouraged.

(a) The FX 9000 and 9003 Protective Face Masks are authorized for use. The FX 9003 Protective Face Mask is specifically authorized for use with DODICs (AB05) and (AB06).

(b) The MCU-2A/P Chemical Biological Mask may be used for face and eye protection only if the hard outer eye shields and the C2 canister are attached prior to use with the SESAMS training system.

(c) A balaclava, towel, or neck scarf will be worn so as not to expose any portion of the neck and throat. A commercially produced neck protector is also available from Simunition, the FX 8000 Protective Throat Collar.

(6) Ensure that the 150 m safety distance (zone) remains clear of unprotected personnel.

f. During SESAMS firing:

(1) Ensure that qualified medical personnel and appropriate medical equipment are available during all SESAMS training exercises (same as live-fire).

(2) Ensure all personnel wear approved hearing protection during all SESAMS training exercises.

(3) Ensure that a minimum safe engagement distance of 2 m (6.5 ft) for the 9mm SESAMS training system and 4 m (13 ft) for the 5.56mm system is established and maintained from the muzzle.

g. After SESAMS firing:

(1) Ensure all weapons are returned to their operational state and a function check is performed.

(2) Account for and return all unused ammunition to the appropriate location in accordance with current applicable directives.

14–15. Close combat mission capability kit (Army)

a. All personnel engaged in CCMCK force-on-force training will wear PPE in accordance with the procedures, restrictions, and other guidance contained in technical/operator manuals, references, and/or pamphlets (TM 9–6920–3700–10). No personnel will be allowed within 75 m of the outermost boundary of the training area when force-on-force training is being conducted without meeting the minimum PPE safety requirements.

b. All participants will be instructed that no head shots will be taken.

c. The minimum engagement distance is 1.5 m (5 ft).

d. All participants will be inspected by the RSO, NCOIC, or OIC prior to the initiation of training to ensure that PPE is worn and that employed individual weapons (M16/M4/M249/M9/M11) have been properly converted to fire low-velocity marking ammunition.

e. Single hearing protection is required to be worn within 5 m of 9mm and 5.56mm weapons using CCMCK marking ammunition during firing. See paragraph 2–11c for eye protection requirements.

f. Tabular data is contained in table 14–6. The SDZ is contained in figure 4–3.

Table 14–6
Close combat mission capability kit (Army)

Caliber	Impact media	Distance X (m)	Distance Y (m)	Vertical hazard (m)	Angle P (deg)	Angle Q (deg)
9mm	Earth/Water	60	N/A	15	N/A	N/A
	Steel/Concrete	60	N/A	15	N/A	N/A
5.56mm	Earth/Water	75	N/A	16	N/A	N/A
	Steel/Concrete	75	N/A	16	N/A	N/A

Chapter 15

Mines, Firing Devices, Trip Flares, Simulators, and Explosive Charges

15–1. General

a. Basic procedures for handling and detonating explosives, mines, firing devices, trip flares, and simulators used by personnel in training are addressed in this chapter. These procedures do not include projectiles, rockets, bombs, fuzes, or firing devices covered in other paragraphs of this pamphlet unless otherwise stated.

b. The following safe practices pertain to standard military and commercial explosives used by the Army, and the Marine Corps, except where noted. They also pertain to items containing explosives such as demolition blocks and mines. Marine Corps units will use the requirements contained in NAVSEA OP5, Volume 1, NAVSEA SWO60–AA–MMA–010, EODB/TM/ TO 60A series, and the Guidebook for Assault Entry Techniques.

(1) For the Army, general safe practices for handling and transporting explosives are prescribed in TM 9–1375–213–12, FM 3–34.214, and DA Pam 385–64. For Marine Corps units, information regarding transportation and

handling of explosives are in NAVSEA OP5, Volume 1, NAVSEA SWO20-AF-ABK-010, NAVSEA SWO20-AC-SAF-010, NAVSEA SWO20-AC-SAF-020, NAVSEA SWO-AC-SAF-030, and MCO 8020.10.

(2) EOD demolition activities will be conducted in accordance with the provisions of AR 75-15 and EODB 60 series publications for U. S. Army EOD personnel, and NAVSEA OP5 and EODB 60 series publications for Marine Corps EOD personnel.

(3) Commercial dynamite will not be stored for prolonged periods at temperatures above 90 degrees because exudation of the nitroglycerin is likely to occur. Storage below 32 degrees tends to make it sensitive to shock. Dynamite will not be moved or transported if there is evidence of exudation or if it has been frozen. In such cases, the dynamite will be considered unserviceable and will be disposed of by EOD personnel. When possible, avoid the use of commercial dynamite in a combat environment due to its storage requirements, sensitivity to moving, and possible detonation from direct fire rounds or artillery fragments. Commercial explosives cannot be burned without risk of explosion. EOD personnel will dispose of commercial explosives.

(4) Unserviceable AE and any AE not to be used as designated for training or operations will be returned to the issuing ASP for disposition.

(5) Some foreign military explosives are not as stable as U.S. explosives. EOD personnel will dispose of foreign explosives under U.S. military control, as appropriate.

(6) Gases released by detonation of explosives are toxic. Avoid exposure to fumes. Position personnel upwind from detonation points and wait until smoke and fumes disperse before proceeding down range.

(7) Buried charges will be primed with detonating cord leading to above ground electric or non-electric blasting caps. Blasting caps will not be buried underground as they are sensitive to shock and may detonate if hit by a metal tool or other hard object.

(8) Detonating cord should be used to prime charges on above ground charges to minimize the need to use blasting caps. Once the explosives charges are primed with detonating cord, the detonating cord will be initiated with an above-ground electric, non-electric blasting cap, or a modernized demolition initiator (MDI).

(9) Lightning and other sources of extraneous electricity (for example, static electricity, high power lines, radio transmitters, and cellular phones) can initiate electro-explosive devices. Electro-explosive devices are subject to hazards of electromagnetic radiation to ordnance. Non-electric blasting techniques are invulnerable to most extraneous electric signals but not to lightning. All demolition training operations must be discontinued at the approach of an electric or severe dust storm.

(10) Detonation circuits will not be connected or armed on any munition unless the intent is to detonate the munition. When munitions are to be detonated, the area will be cleared of all non-mission-essential personnel with a minimum crew remaining to connect the detonation circuit. Live blasting caps or other live detonators will not be located at training sites if munitions are not to be detonated.

(11) All personnel within the SDZ will wear approved protective helmets and hearing protection for all detonations, including while in the confines of missile-proof shelters. IBA, helmet, and hearing and eye protection (Army)/PPE Level 1 (Marine Corps) will be worn by personnel within the SDZ but outside the missile-proof shelter.

(12) Only mission-essential personnel (Army)/ participating personnel (Marine Corps) will be allowed in SDZs during firing.

c. When temporary open storage of explosives is used, stacks will not exceed 227 kilogram (kg) (500 pound (lbs)) of explosives. Distance between stacks should not be less than 45 m (150 ft). The RMTK On Range Ammunition Handling Tool (ORAHT) should be used to produce explosive danger zones for single or multiple DODICs when the munitions to be stored are in total support of the training mission.

(1) For the Marine Corps, the RMTK ORAHT should be used to produce explosives danger zones for single or multiple DODICs when the munitions to be stored are in total support of the training mission.

(2) For the Army, the RMTK ORAHT may be used to produce explosives danger zones for single or multiple DODICs when the munitions to be stored are in total support of the training mission.

d. Live and inert munitions/demolitions will not be mixed.

e. Demolitions effects simulators which contain live explosives, as well as other simulators, are considered live munitions.

f. Basic demolition training will include the following procedures:

(1) Procedures in FM 3-34.214 will be used for all training in the use of demolitions. Field expedient methods outlined in applicable field manuals are authorized for use. Unit commanders will receive prior approval from the installation RMA (Army), RCO (Marine Corps) with concurrence of the installation safety manager (Army) prior to conducting activities employing field expedient procedures or explosives.

(2) While engaging in demolition training, the minimum distances given in paragraph g may be reduced to 50 m (165 ft) if bare charges of not more than 2.27 kg (5 lbs) are used on the surface of specially prepared sites. The site condition will conform as follows:

(a) Charges will be detonated on a sand cushion that has been screened and is pebble or stone free (material passes

through a #10 sieve). The sand cushion will not be less than that specified in table 15–1. Subsequent charges will not be placed where cratering from previous detonations has reduced the depth of sand.

(b) Charges will be detonated on soil free from gravel, rock, metal or other possible missiles to a depth of at least 0.15 m (6 in). Ground preparation will include loosening and raking the soil. A barricade constructed of sandbags or other suitable protective material at least 1 m above the surrounding level of ground will be provided between the location of the charge and personnel. Charges will be placed not less than 1 m or more than 2 m from the barricade. The detonation site will be maintained to prevent formation of clods or exposure of gravel or rock on or near the surface. It is helpful to place a layer of porous, water permeable matting (geo-textile fabric consisting of woven nylon, and polyester) between a rocky layer of soil and the upper layer of soil that must be free of gravel, rock, metal, or other potential missiles. This will help prevent contamination of the upper soil layer from the migration of gravel and rock and help reduce long-term maintenance costs.

(3) During basic or familiarization demolition training, instructors will supervise not more than five students while they are priming individual charges. Not more than five students will prime charges at a time. The remainder of students and observers will withdraw to a safe position before priming occurs.

(4) Single charges placed against steel, concrete, wood, or other solid material during training or demonstrations will be emplaced on the side nearest observers so that major fragments are propelled away from the observers.

(5) Dual initiation systems are preferred over single initiation systems to increase reliability. Consult FM 3–34.214 and use the best combination of initiation systems to decrease the possibility of misfires.

g. Explosives can propel lethal fragments and debris hazards great distances.

(1) The distance explosion-propelled fragments or debris will travel in air depends mainly on the relationship between weight, shape, density, initial angle of projection, and initial velocity. Fragment and debris hazards from steel-cutting charges extend a greater distance under normal conditions than that from cratering, quarrying, or surface charges of bare explosives.

(2) Fragment and debris hazard distances at which personnel in the open are relatively safe from missiles created by bare charges placed in or on the ground, regardless of type or condition of the soil, are as follows:

(a) Charges more than 227 kg (500 lbs): Minimum 800 m fragment and debris hazard distance.

(b) Charges from: 12 kg (27 lbs) to 227 kg (500 lbs) charges, computed from the formula: Safe distance in meters = 100 times the cube root of the pounds of explosive ($D = 100 \times W^{1/3}$).

(c) Less than 12 kg (27 lbs): Minimum 300 m fragment and debris hazard distance.

(d) See table 15–2 for computed safe distances for personnel near bare charges.

(3) For 0.25-pound charges used to simulate enemy artillery fire and mortar fire that are detonated in specially constructed demolition pits constructed as described in paragraph 15–10e(8), the minimum distance may be reduced to not less than 3 m.

h. Blast effects generate hazards.

(1) Generally, the greatest danger to personnel is missiles thrown by an explosion. However, blast effect (such as an increase in air pressure) also generates hazards to personnel located within the SDZ. Special protective features used at detonation or demolition sites to eliminate or confine missiles may not reduce or mitigate overpressure and noise hazards.

(2) Hearing protection is required for any exposure to noise greater than 140 dBP. Follow the hearing protection recommendations listing in the technical manuals for the explosive devices used. If the hearing protection recommendations are not listed in the manuals, compute the 140 dBP contour from the formula: Distance to 140 dBP contour in meters = 300 times the cube root of the weight of explosive in kg ($D = 300 \times W^{1/3}$). Table 15–3 contains the distances for various weights of explosives.

i. The following methods are used for charges placed on steel and concrete

(1) Charges placed on steel.

(a) The preferred method of employing steel cutting charges is in a bunker designed for that purpose. Steel cutting charges (amount of explosives and placement) will be calculated based on appropriate formulas and tables in FM 3–34.214.

(b) If a steel-cutting bunker is not available, charges will be fired in an excavated pit that is at least 1 m deep. Steel-cutting charges fired outside of a steel-cutting bunker will not exceed 0.9 kg (2 lbs).

(c) Personnel must be a minimum of 100 m from the charge at detonation in a missile-proof shelter, 300 m in defilade, or 1,000 m if in the open.

(2) Charges placed on concrete. Charges placed on concrete will not exceed 18 kg (40 lbs) and should be placed on the side nearest observers. Observers must be at least 100 m away in a missile-proof shelter, 300 m away in defilade, or 900 m away in the open. An unoccupied distance of 900 m will be provided on the opposite side of the charge where most missile hazards will be thrown.

(3) For the Army, all personnel will wear approved protective helmets, IBA, eye protection, and single hearing protection. For the Marine Corps, PPE Level 2.

j. Explosive entry techniques are used in special missions where assault personnel require immediate access to the

target. To train for this type of mission, individuals may be required to be closer to the detonation than authorized by this pamphlet in paragraph 15–12. Such operations will require a deviation in accordance with chapter 1 of this pamphlet.

15–2. Firing devices

a. Electrical firing will be used with caution and will be replaced by non-electric firing systems when the possibility exists of unintentional detonation from extraneous electrical energy sources (for example power transmission lines, cellular telephones, generators, radios, or any weather conditions which produce static electricity or lightning). Electric blasting circuits must be checked for stray electromagnetic energy by using a test set. Test sets will not detect non-transmitting portable equipment that may be in the vicinity. Therefore, total reliance must not be placed on these detection methods to ensure the safety of personnel. Areas selected for demolition training sites will be surveyed for electromagnetic energy. This survey is an installation responsibility. Areas will be controlled to prevent entry of portable transmitting equipment from the surrounding area. The data in tables 15–4, 15–5, and 15–6 showing transmitter and radiative power in watts and minimum separation distances to electric blasting operation apply to operation of a radio, radar, and television transmitting equipment.

b. Electric firing will not be used for demolition training when surveys show that the transmitted field strength exceeds energy levels shown in tables 15–4, 15–5, and 15–6.

c. Static electricity will be eliminated or non-electric firing systems will be used.

d. Approved firing devices (for example, M1, M1A1, M3, M5, M122, XM122, M142, and M152) employed in accordance with Army and Marine Corps FMs and TMs are authorized for use with practice mines. Since these firing devices can be configured with practice and HE activators, care must be taken to ensure the proper activator is assembled to the proper mine. HE activators will not be used with training mines.

e. A dual electric disconnect system will be used when installing electrical firing systems on demolitions. The main source of power will be turned off and a lockout device will be used.

15–3. Shaped charges

a. Shaped charges will be oriented so that gas jets will be directed toward the target. When practicable, charges should be placed on the side of the target nearest to observers, so that the blast is directed away from them. Observers will be at least 100 m away in a missile-proof shelter, 275 m in defilade, or 1,000 m for unprotected personnel, from shaped charges when fired.

b. For the Army, all personnel will wear approved protective helmets, IBA, eye protection, and single hearing protection. For the Marine Corps, PPE Level 1.

c. The MK47 Mod 1 demolition shaped charge requires a safe separation distance of 300 m for protected personnel. For unprotected personnel, the stand-off distance is 1,610 m.

15–4. Bangalore torpedoes

a. Bangalore torpedoes will only be fired while on the ground in a horizontal position. Personnel will be in a missile-proof shelter 100 m from the charge, or 200 m away in defilade. For unprotected personnel in the open, the minimum safe distance (MSD) is 1,000 m at right angles to axis of the Bangalore torpedo, 200 m for personnel in the line of axis. If an improvised Bangalore torpedo, in which the explosive weight exceeds the standard, is used against a steel target, fragments (missiles) could be produced which may fly further than the MSD. In that case, the SDZ for steel cutting charges should be used, otherwise, the SDZ for a standard Bangalore torpedo may be used for an improvised Bangalore torpedo. This SDZ must be approved by the installation RMA (Army), RCO (Marine Corps).

b. For the Army, all personnel will wear approved protective helmets, IBA, eye protection, and single hearing protection. For the Marine Corps, PPE Level 1.

15–5. Mine-clearing line charge

a. *Firing conditions.*

(1) Because of high exhaust temperatures, the mine-clearing line charge will not be towed behind an M1 Abrams tank.

(2) Non-participating personnel will not be allowed within the mine-clearing line charge SDZ or noise hazard contour during firing.

(3) Only participating personnel are allowed within Area F. Such personnel will be in an armored vehicle in a button-up mode with approved single hearing protection.

(4) The M68 inert charge should not be fired more than three times as additional firings may result in breakage of charge blocks and erratic flight of the rocket. Units will record number of firings in accordance with unit SOP.

(5) When firing the M154 Kit, all amphibious assault vehicle hatches will be closed (Marine Corps).

b. *Surface danger zone.*

(1) SDZ requirements for firing the mine-clearing line charge with M58 HE charge are provided in figure 15–1.

(2) The SDZ requirements for firing the mine-clearing line charge with M68 inert charge are provided in figure 15-2.

(3) Distance X takes into account the most probable event of charge or cable separation or an unrestrained rocket motor impacting downrange.

(4) If the detonation command link severs during a charge or cable separation, detonation of the HE charge will not occur.

(5) The fragmentation zone required for the HE charge is for containment of fragments and debris of a normal mine-clearing line charge impact.

(6) Mine-clearing line charges will not be destroyed by burning. They contain booster charges that detonate when exposed to heat or pressure. Misfired or dud line charges will be destroyed by EOD personnel only after all misfire procedures have been performed by the firing unit.

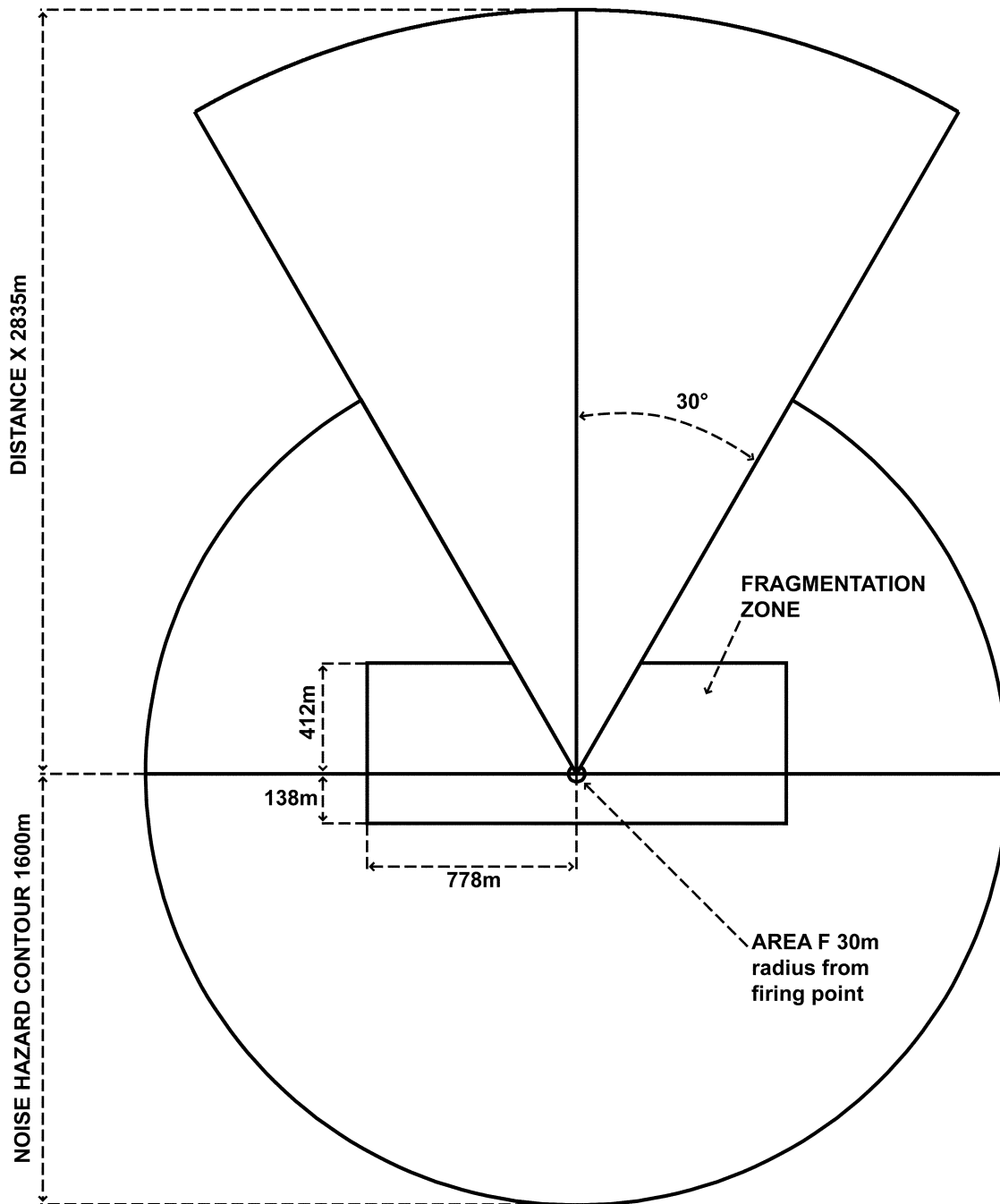

Figure 15-1. Surface danger zone for firing a mine-clearing line charge with the M58 HE charge

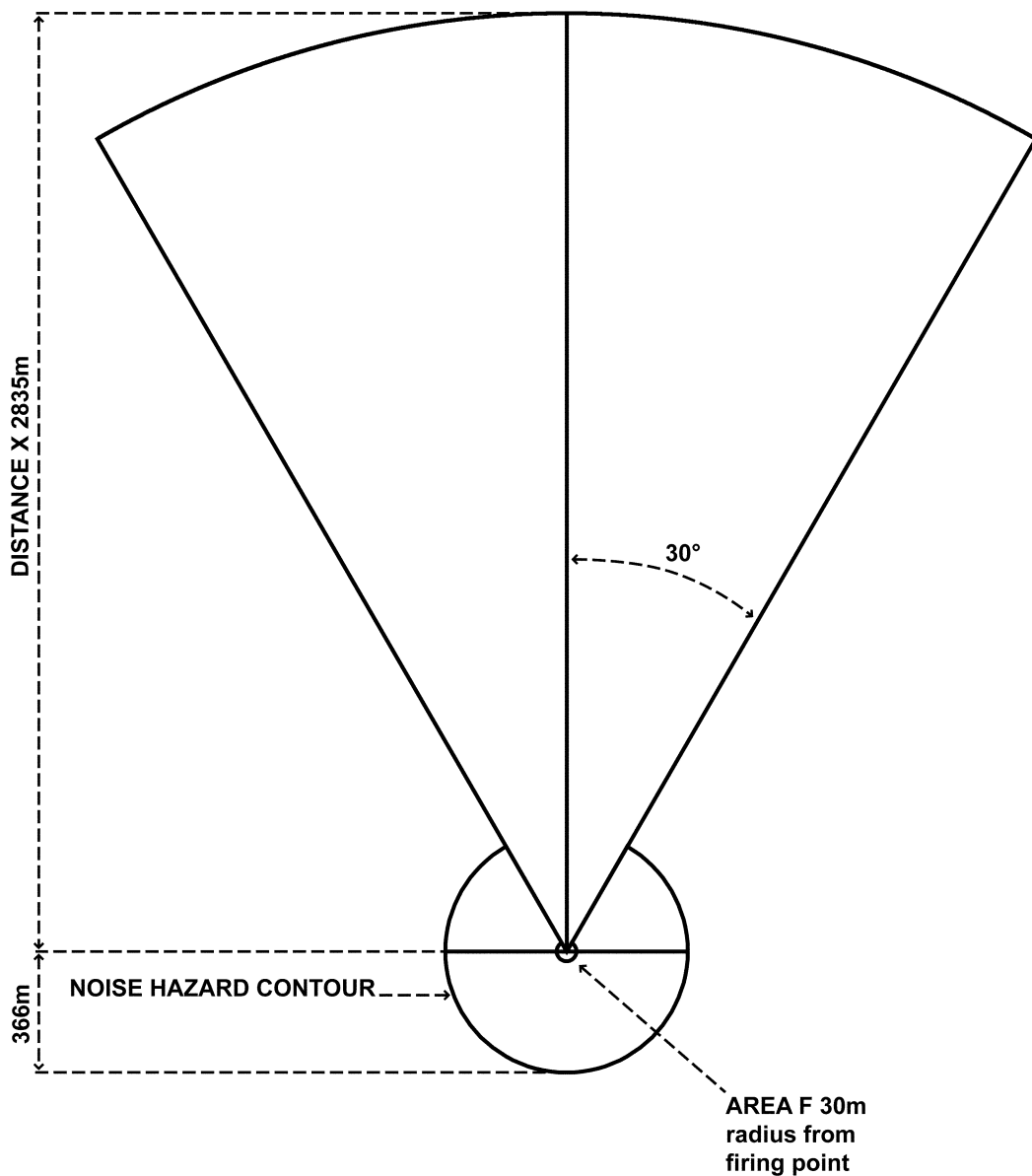

Figure 15-2. Surface danger zone for firing mine-clearing line charge with the M68 inert charge

c. Anti-Personnel Obstacle Breaching System.

- (1) Anti-Personnel Obstacle Breaching System firing personnel will be at least 50 m from the launch point and 75 m from the deployed grenades and in a prone position. In the event of a catastrophic detonation at the launch point, the rear exclusion area will protect personnel provided that they are in the prone position and use hearing protection.
- (2) Personnel without hearing protection shall not be permitted within 1,187 m of the launch point.
- (3) SDZ requirements for firing the Anti-Personnel Obstacle Breaching System are provided in figure 15-3.
- (4) Vertical hazard for the Anti-Personnel Obstacle Breaching System is 1266 meters.

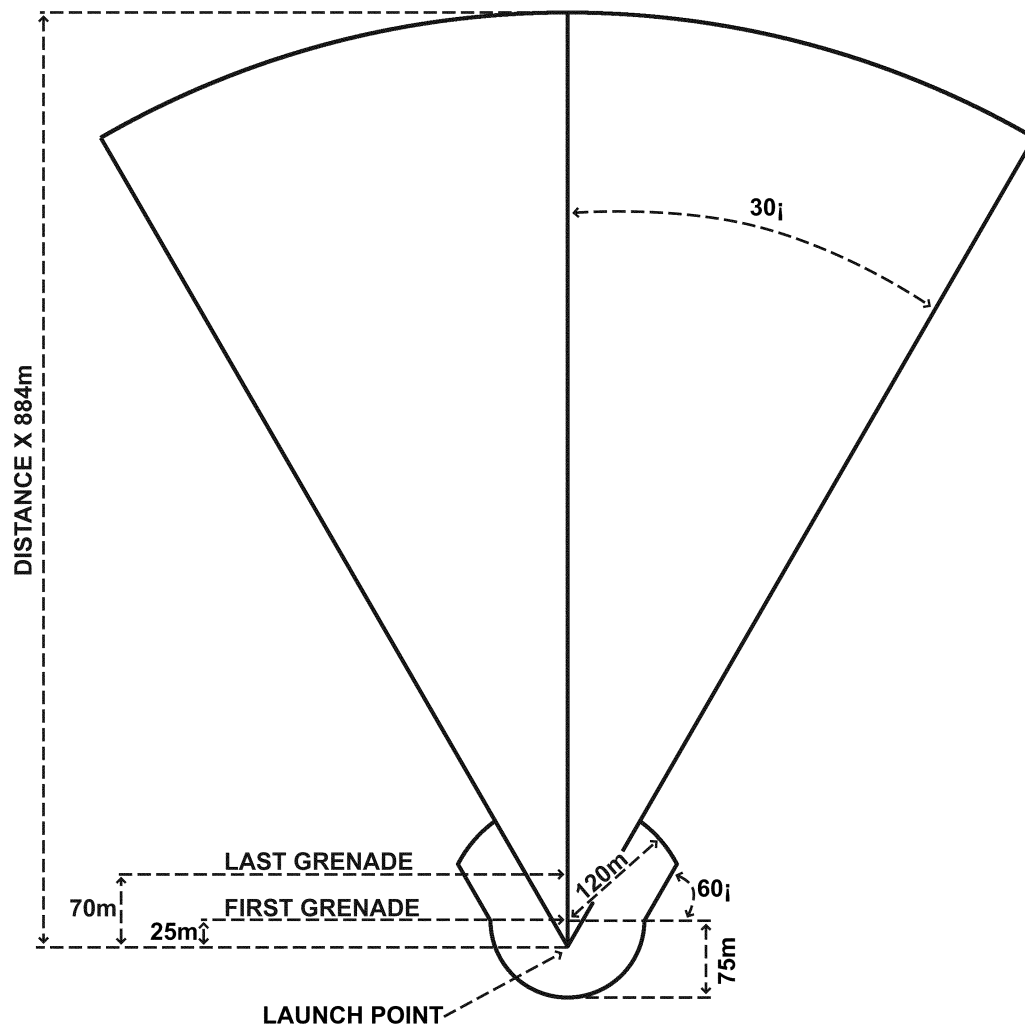

Figure 15-3. Surface danger zone for firing the Anti-Personnel Obstacle Breaching System

15-6. Cratering charges

- a. The maximum charge to be fired in training will not exceed 145 kg (320 lbs).
- b. MSD for personnel not in missile-proof shelters will depend on the net explosive weight of explosive used. MSD for up to 2 kg (5 lbs) is 100 m; for up to 30 kg (66 lbs) is 300 m; over 30 kg (66 lbs) is 500 m.
- c. For the Army, all personnel will wear approved protective helmets, IBA, eye protection, and single hearing protection. For the Marine Corps, PPE Level 1.
- d. Missile-proof shelters, if strong enough to withstand any material propelled onto it by the detonation, located not less than 100 m from the detonation site may be occupied by personnel.
- e. All cratering charges will be dual primed with detonating cord. Blasting caps will not be placed underground. Electric or non-electric caps or MDI will be attached to the detonating cord above ground.

15-7. Mines

- a. Practice and inert mines will be color coded in accordance with MIL-STD-709D and TM 9-1300-200, paragraph 8-6, and will have the appropriate identification marking stenciled on them. Service, practice, and inert mines and fuzes will not be mixed.
 - (1) Inert mines and mine fuzes do not present a safety hazard. They will be color-coded and marked in accordance with MIL STD-709D to prevent mixing with practice and HE mines.
 - (2) Practice mines and their fuzes contain a small, low explosive charge or a smoke producing increment. They will be color coded in accordance with MIL STD-709D.

- b. Training with non-self destruct mines is prohibited.
- c. Claymore antipersonnel mines will be operated under the following conditions:
 - (1) *Firing conditions.*
 - (a) Range OIC will ensure mines are installed correctly and facing into the impact area.
 - (b) All mines will be secured until the range OIC directs their issue.
 - (c) Emplaced mines will not be disarmed except by order of the range OIC.
 - (d) Firing devices will only be connected at the command of the range OIC.
 - (e) When more than one mine is to be fired, the range OIC will ensure that previous firings have not dislodged the other mines in the impact area.
 - (f) After firing, the impact area will be inspected to ensure that all mines have detonated.
 - (g) Misfires will be handled in accordance with TC 3-22.23.
 - (h) Personnel will not be allowed within 16m to the rear of the mine. Firing personnel may occupy an area between 16 and 100 m to the rear of the mine if they are located in a covered position, lying prone in a depression, or behind a physical barrier. All personnel will wear approved protective helmets, IBA, eye protection, and single hearing protection. When the mine is tied to a tree or fired in an area that attenuates the secondary missile hazard, friendly troops within a 16 m to 50 m radius behind the mine must be in a covered position.
 - (2) *Surface danger zone.*
 - (a) SDZ requirements for firing the M18 and M18A1 Claymore mine are provided in figure 15-4.
 - (b) Vertical hazard for the claymore is 400 m.
 - (c) Care must be exercised when installing mines to prevent the creation of secondary fragment and debris hazards.
 - (d) For the Army, all personnel will wear approved protective helmets, IBA, eye protection, and single hearing protection. For the Marine Corps, PPE Level 1.

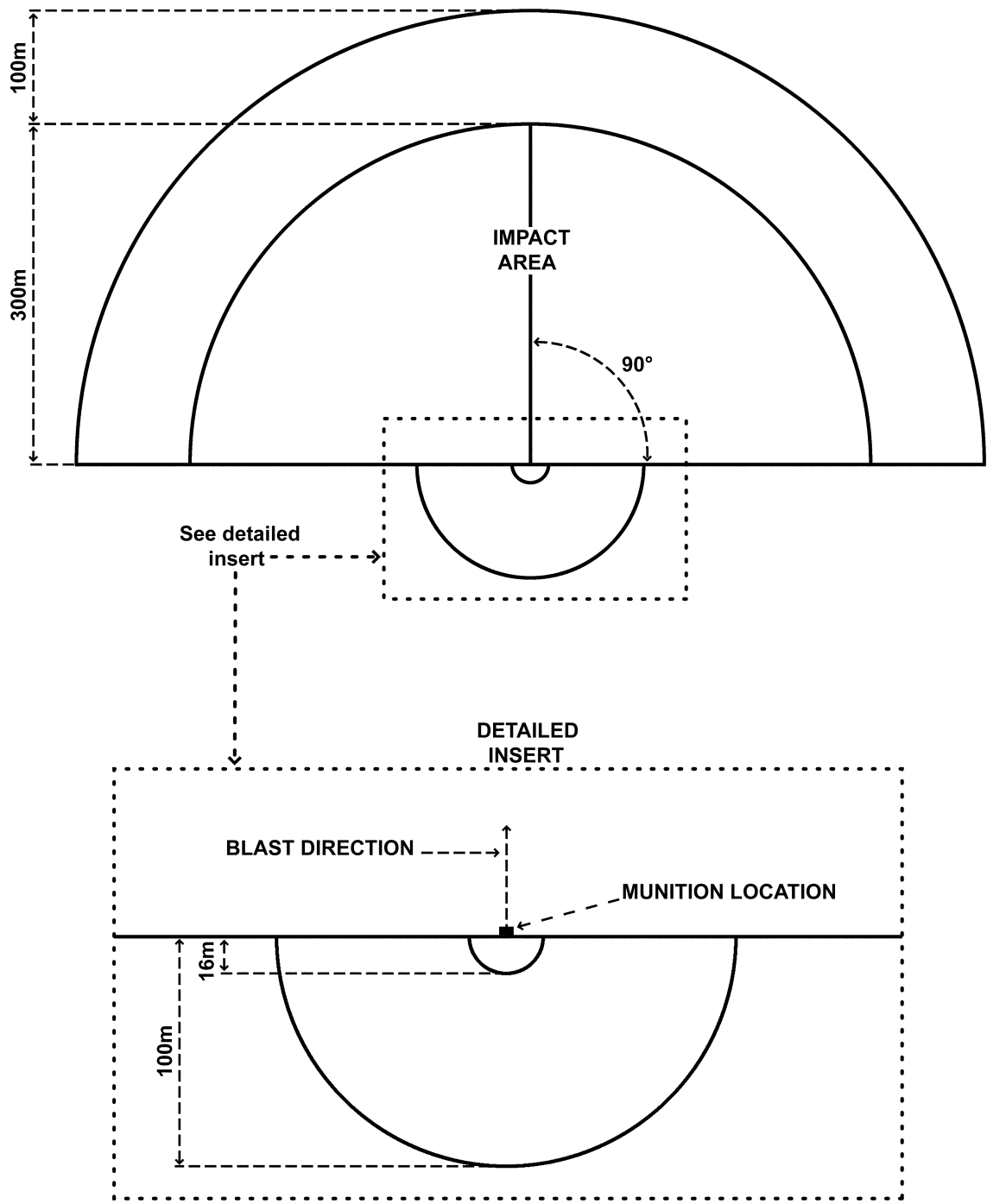

Figure 15-4. Surface danger zone for firing Claymore mines

d. The Volcano multiple delivery mine system is a rapid mine-dispensing system for launching antitank mines from various vehicles. The air system uses UH-60 Blackhawk helicopters. SDZ requirements for the air system are shown in figures 15-5 and 15-6. The SDZ for the air system is dependent upon aircraft speed, altitude, and the dispenser control setting. The ground system uses cargo or dump truck. SDZ requirements for the ground system are shown in figures 15-7 and 15-8.

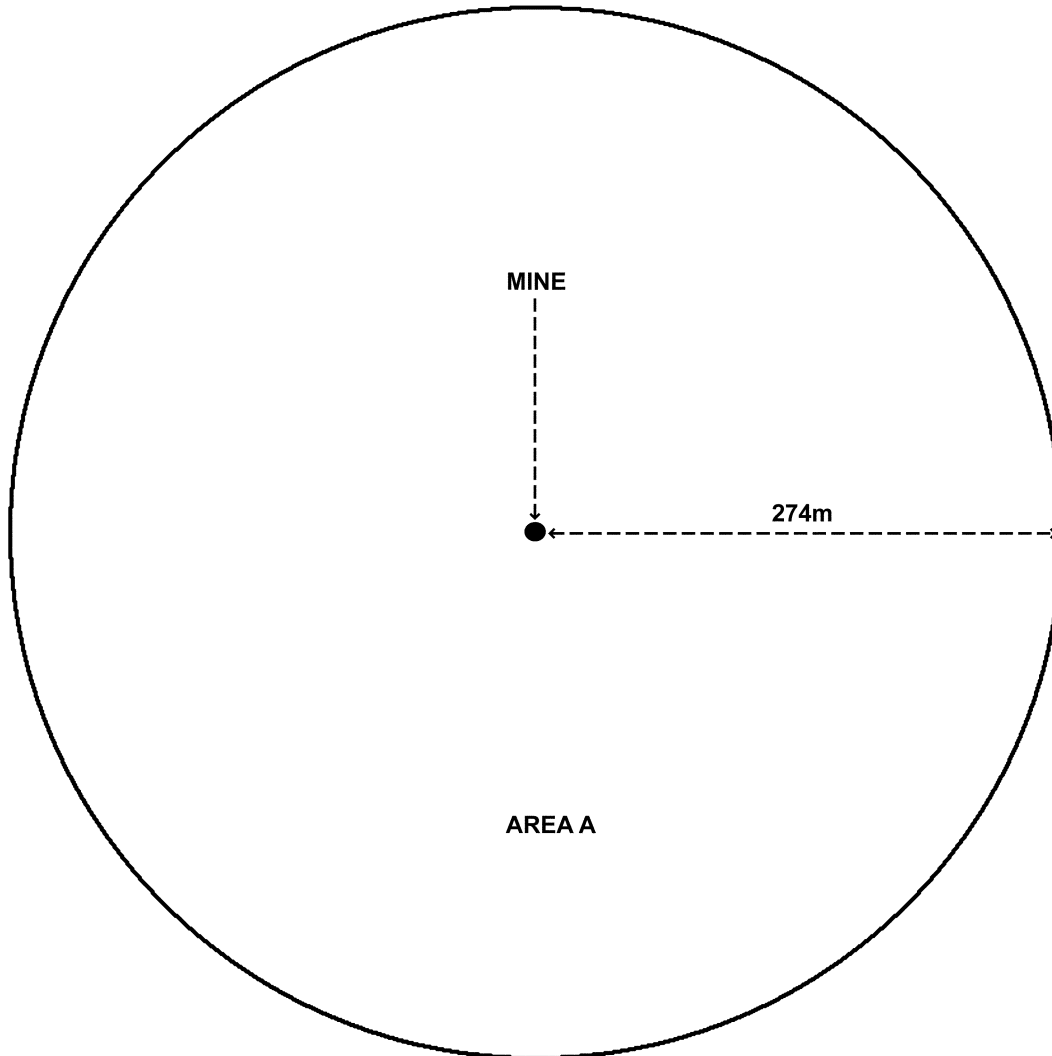

Figure 15-5. Surface danger zone for Air Volcano anti-personnel multiple delivery mine system

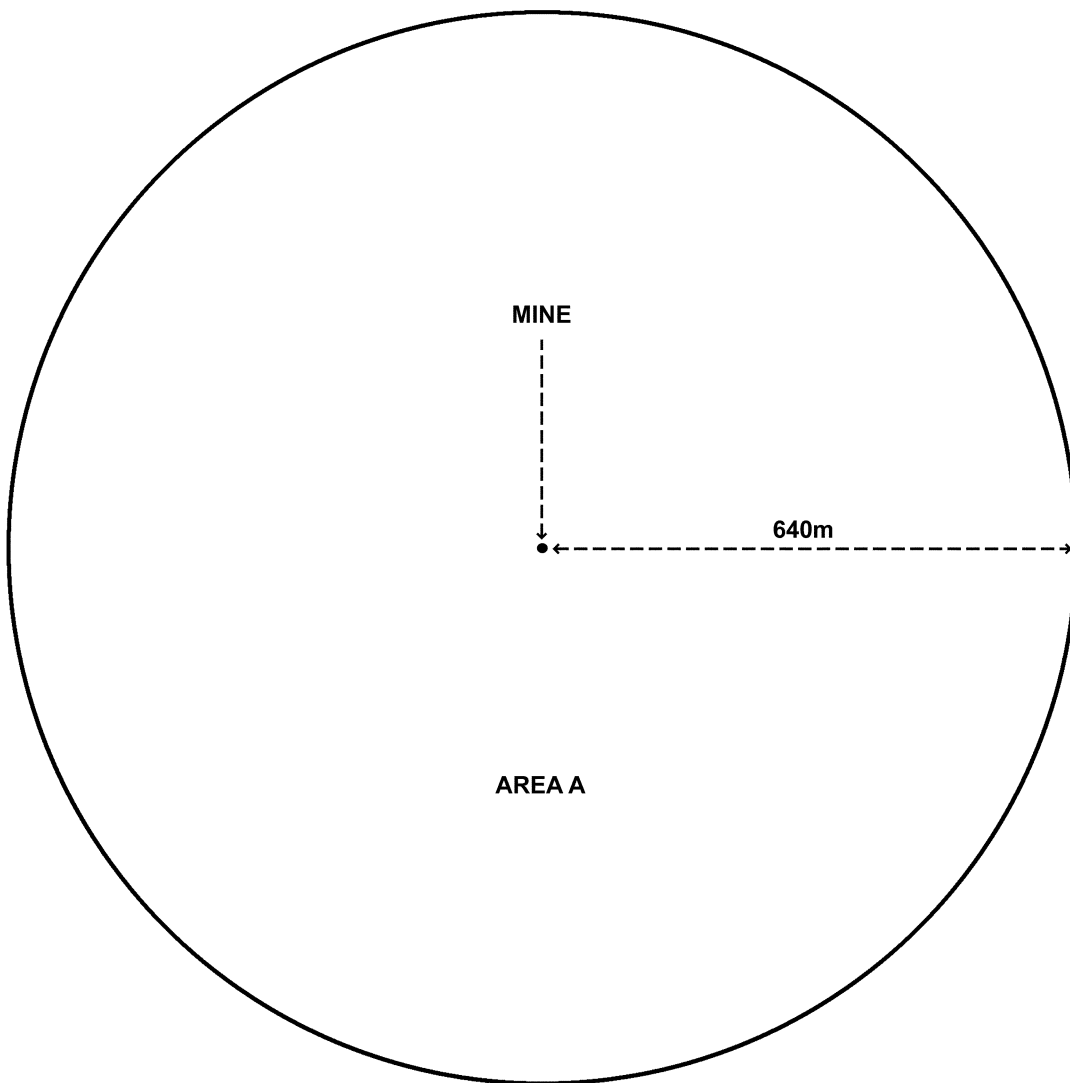

Figure 15-6. Surface danger zone for Air Volcano Anti-Tank multiple delivery mine system

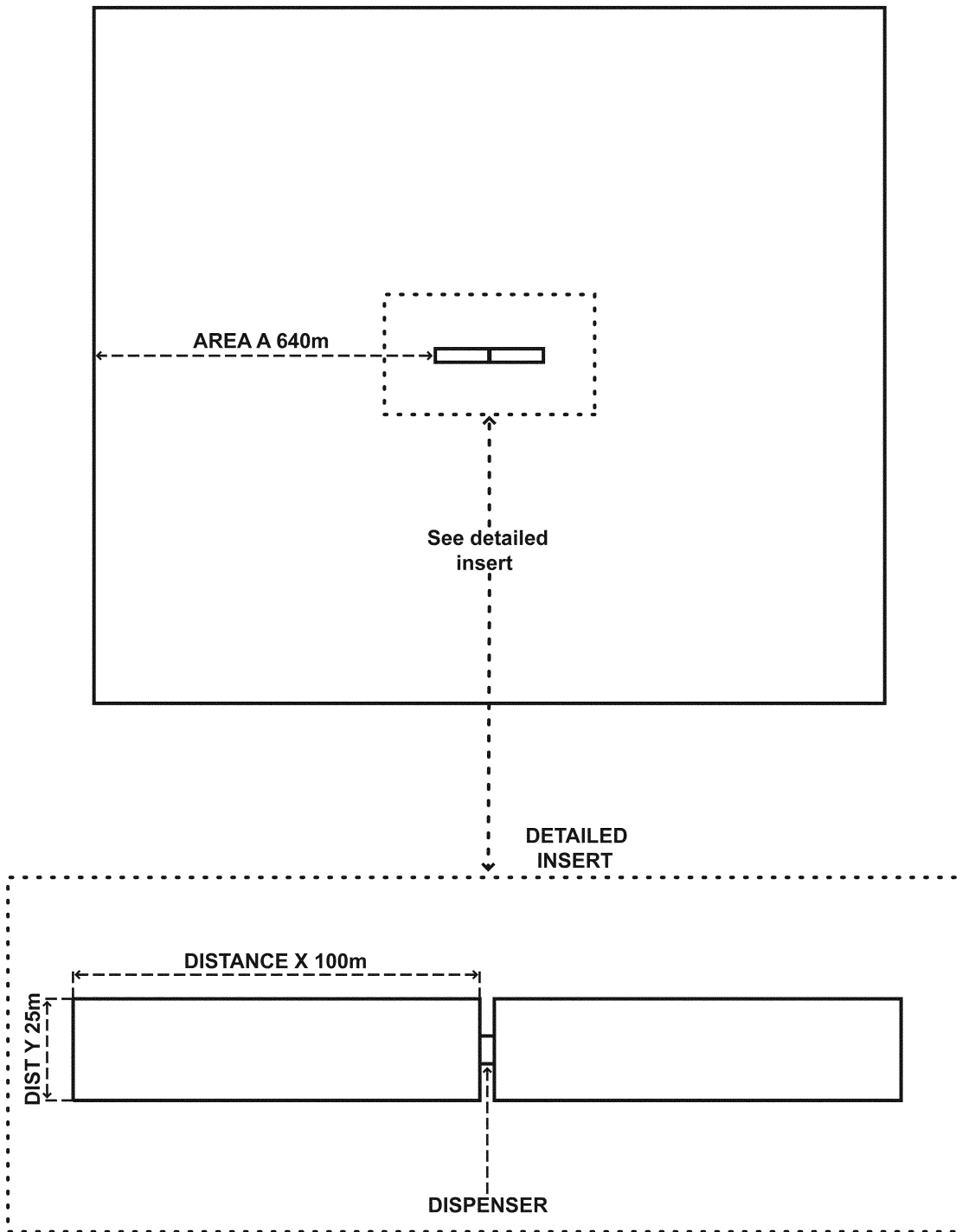

Figure 15-7. Surface danger zone for M87/M87A1 Ground Volcano multiple delivery mine system

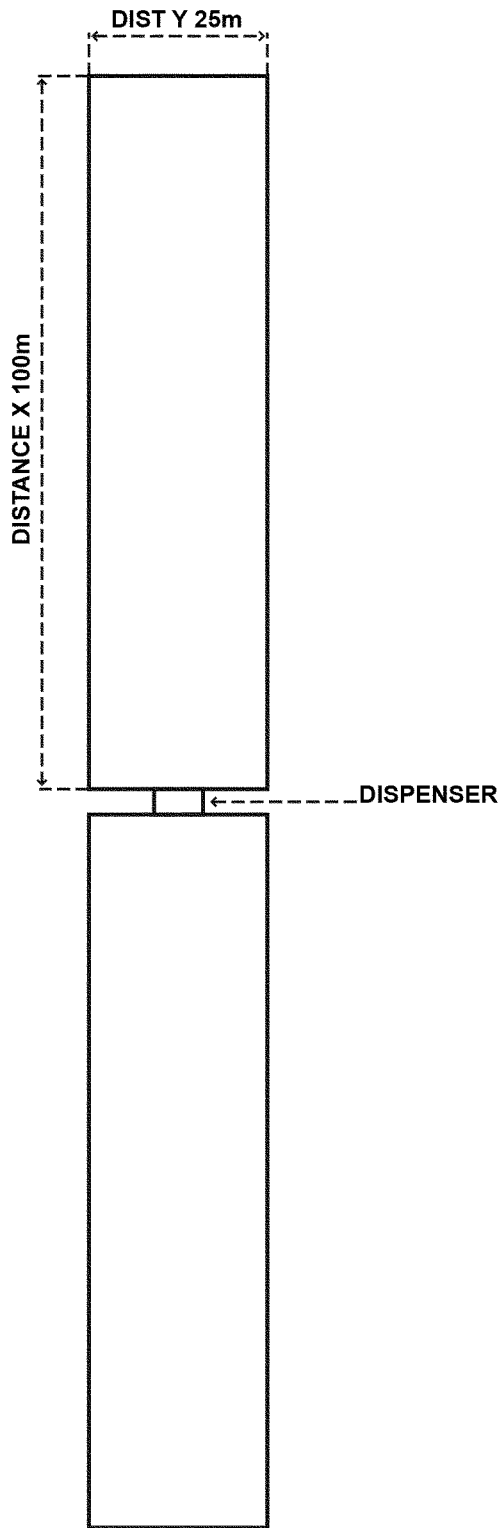

Figure 15-8. Surface danger zone for M88 Ground Volcano multiple delivery mine system

e. Spider XM7 Network Command Munition is a remote controlled anti-personnel munition system. It is composed of three main components:

(1) The Remote Control Unit is a handheld computer used to monitor and control the functioning of the Spider munition field.

(2) The Repeater is a relay device that is used, if necessary, to extend the downrange control of the Remote Control Unit.

(3) The Munition Control Unit can employ up to six Miniature Grenade Launchers (MGLs). Each MGL has a minimum safe distance of 138m.

(4) Instead of MGLs, the Munition Control Unit can employ up to six Munition Adapter Modules (MAMs). A MAM provides the interface to fire attached lethal and/or non-lethal munitions, (such as the M18 Claymore, the M5 MCCM, and MDI-initiated explosives to include the shock-tube initiation devices such as the M11, M12, M13, M21, and M23. The recommended SDZ for the Spider XM7 using the MAM will depend on what types of peripheral device(s) (either lethal or non-lethal) are connected.

15-8. Firing devices

a. Instructions in TM 9-1375-213-12 will be followed when installing, arming, and disarming firing devices.

b. Firing devices and fuzes, either with or without the standard bases, will not be pointed at personnel.

c. Standard bases containing unfired percussion caps, firing devices, and fuzes will not be carried in the pocket.

d. Standard bases containing unfired percussion caps will be kept separated from firing devices and fuzes until the firing device or fuze is ready to be installed in the mine or booby trap.

e. Safety pins on firing devices and fuzes should be checked for ease of movement before attaching the standard base. The safety pins for locking and positive safeties should easily move.

f. Before removing the tripwire, the positive safety will be installed on armed firing devices or fuzes having a tripwire attached.

g. The assembly, arming, and disarming of antipersonnel mine fuze M605 will be in accordance with TM 9-1345-203-12.

15-9. M48 and M49 trip flares

a. Use inert flares to instruct students in the use, emplacement, and fuzing of service flares.

b. Fence or guard each service trip flare used in training to prevent personnel from approaching within 2 m of the emplaced flare.

c. Clear trip flare firing positions of flammable material to prevent accidental fires. Do not use the M48 trip flare in areas where fire could cause serious damage.

15-10. Simulators

a. M80 explosive simulators detonate 3 to 5 seconds after ignition of the fuse cord and are capable of causing serious injury. Fuse cord tips should not be split since this reduces burning time and increases the potential for injury to personnel. Do not use M1 and M2 type fuse igniters to ignite the M80 fuse cord or hold the M80 simulator when ignited.

b. Procedures for the safe use of other simulators are contained in TM 9-1370-206-10, TM 9-1370-207-10, and TM 9-1370-208-10. No attempt will be made to disarm or disassemble simulators.

c. See TM 9-1370-207-10 for the M142 atomic explosion simulator firing precautions.

d. Commercially manufactured fireworks (designated for civilian use) will not be handled, stored, or used in any way by military personnel on an installation.

e. When explosive charges (TNT blocks or composition C4) are used to simulate detonation of mines and incoming artillery projectiles, mortars, and bombs during exercises or on the infiltration course, the following procedures will be used:

(1) Charges will be fired in specially prepared detonation pits with the charge positioned in the center of the pit. See paragraph (8) for demolition pit requirements.

(2) Only charges of standard issue TNT blocks or composition C4 of one-quarter pound will be used. Composition C4 may be cut into 0.25-pound blocks in accordance with FM 3-34.214. TNT blocks will be cut in accordance with the instructions in the corresponding TM.

(3) Charges will be detonated electrically from a position that allows a clear view of the pit and the immediate vicinity. Follow safety precautions in paragraph 15-2, and tables 15-1 through 15-3 when using electric blasting caps and circuits.

(4) Blasting circuit wires leading to charges in the detonation pits will be buried, preferably in conduit, or otherwise secured to prevent personnel from becoming entangled in or tripping over the wires.

(5) Only one charge will be emplaced in a pit at a time.

(6) Pits will be inspected and cleared of objects prior to emplacing charges to remove potential hazardous missiles.

(7) Charges may only be detonated when crawling personnel are 3 m or more from the center of the pit and erect personnel are 25 m or more from the pit.

(8) Detonation pits will be constructed in the following manner:

(a) Pits will be excavated in the shape of a cone at least 1.5 m in diameter by 0.6 m deep. Excavated pits will be backfilled 0.3 m with clean, clay-free sand that has passed through a #10 screen. Any object larger than sand grain size is considered a pebble. Pits will be free draining so that the sand filled area will quickly drain clear of water. Soil conditions may require that drains be constructed.

(b) A ring of sandbags or other suitable barrier material (for example, treated timbers) 0.6 m high with an inside diameter of 2 m will be constructed around each pit. Construct a barrier at least 1 m outside of the sandbag rings that does not project above the top of the sandbags. These detonation pit barriers will be physically different from any other barrier which personnel are expected to negotiate and will be sufficient to keep personnel 1 m away from the detonation pits.

(c) Dimensions given above for detonation pits and sandbag rings with barriers are minimum requirements and will not survive extensive use without frequent maintenance. Larger diameters and depths, as well as double-walled sandbag rings, are recommended for detonation pits used more than once a week.

(d) A dual electrical disconnect system will be used when charges are being placed in the pits. The main source of power will be turned off by the individual placing the charge in the pit. Once the power is turned off, a lockout device will be used.

f. Demolitions effects simulators (DES) charges are explosives which use detonating cord, blasting caps, a modern demolition initiator, cardboard, and sand or chalk to simulate other explosives. Extreme care must be exercised when using DES. DES is an explosive and all safety guidance contained in this pamphlet and FM 3-34.214 must be followed. All procedures and MSDs for the charge that is simulated must be followed. For example, a DES bangalore torpedo would require the same MSDs and procedures for an actual bangalore torpedo. All demolitions effects simulators must be marked as DES.

g. Improvised explosive device (IED) simulators provide visual and audible effects with minimal risk to participants. These devices can be remote-detonated or hard-wired for direct firing.

(1) The use of non-pyrotechnic IED simulators with pyrotechnics and/or explosives is not authorized.

(2) The use of flour or starch-based products in place of the recommended smoke simulation powders is not authorized. Flour and starch-based products can be flammable and the resulting plume of flour or starch-based product could ignite should an ignition source be present.

(3) Non-pyrotechnic IED simulators can produce extreme recoil reaction when initiated. Simulators must be secured using ground stakes and/or sandbags.

(4) Never attempt to alter non-pyrotechnic IED simulators or operate them with any altered, broken, or missing parts. The misuse of this equipment may cause serious injury or death.

(5) Remote initiators must be in the possession of the individual making the electrical or pneumatic connections. Initiators will not be connected to the non-pyrotechnic IED simulator until all safety requirements have been met.

(6) Hazard areas for IED simulators are contained in equipment instruction manuals and must be enforced at all times. Personnel within the hazard area of a non-pyrotechnic IED simulator will wear the following PPE: eye protection, single-hearing protection, and helmet.

(7) Do not place a non-pyrotechnic IED simulator in such a manner that it will be pointed at personnel when initiated.

(8) Should a non-pyrotechnic IED simulator fail to function, a wait time of 10 minutes is to be observed prior to approaching the simulator. Simulators are to be disarmed (disconnect the device from the initiator) and approached from the base end. Ensure discharge end is pointed down range and that the device is secured to prevent movement.

(9) All setup, training, and disassembly involving live (armed) non-pyrotechnic IED simulators will be conducted outdoors.

(10) Non-pyrotechnic IED simulators will not be stored, carried, or transported live. They are not to be assembled until they are on site and being readied for immediate use.

(11) OICs, RSOs, and personnel using non-pyrotechnic IED simulators will receive training prior to receiving equipment and the use of it in training exercises. Only those personnel who complete the required training will be authorized to draw the equipment from issue sites.

(12) Strict accountability must be maintained of non-pyrotechnic IED simulators as they are functional and realistic in appearance.

(13) The compressed CO₂ gas used to activate the cuing devices can cause serious injury or death if improperly

handled. Follow safety instructions in equipment instruction manuals regarding the use of the CO₂ gas and its containers.

15–11. Safety requirements for firing aerial pyrotechnics (Marine Corps only)

a. Personnel participating in exercises that include the firing of aerial pyrotechnics such as Smokey Sams or Smokey Guns will wear PPE Level 1 and other protective equipment required by SOPs.

b. Inspect Smokey Sam rockets prior to use and report all rockets that appear to have moisture damage. Damaged rockets will not be fired.

c. When firing these pyrotechnics, anyone may stop the firing sequence if it is not safe to fire, or if the dispensing aircraft is within 610 m (2,000 ft) as prescribed in NAVAIR TM 11–75–63.

15–12. Training conducted in explosive entry techniques

a. Explosive entry techniques are used in special missions where assault personnel require immediate access to the target. To train for this mission, individuals must be closer to the detonation than is authorized elsewhere in this chapter. Because of the unique character and requirements of this training, the following special safety guidelines are established to support this training.

(1) Stand-off distance for personnel will be determined using the formula $D_{(ft)} = K \times W^{1/3}$ where D=distance, K=a constant (the K factor for explosive entry techniques is set at 18) and the $W^{1/3}$ =cube root of weight of the explosives in pounds. This is the limit at which the possibility of eardrum damage is less than 1 percent. This stand-off distance is related to blast pressure and does not reflect fragmentation damage. When a barrier is used, the safe overpressure standoff distance may be divided by 2.

(2) Fragmentation standoff will equal the blast standoff when a protective barrier is provided between the explosive and the personnel. This barrier may be in the form of wood, cement, metal, or a ballistic blanket barrier. The barrier must be able to absorb all fragmentation.

(3) All personnel within the fragmentation distance of a detonation will wear appropriate protective gear. For the Army, all personnel will wear approved protective helmets, IBA and single hearing protection. For the Marine Corps, PPE Level 2. Eye protection will be worn. Personnel conducting the detonation will also wear fire-resistant hoods, coveralls, and gloves. Clothing with short sleeves is not authorized when conducting this training.

b. For the Marine Corps, SDZs for ranges dedicated to the conduct of explosives entry techniques will be set and approved by CG, MCCDC (C465).

15–13. M2 and M4A1 Selectable Lightweight Attack Munition and the M3 Demolition Attack Munition

a. The M2 and M4A1 Selectable Lightweight Attack Munition (SLAM) and the M3 Demolition Attack Munition (DAM) is a multipurpose munition with anti-disturbance and anti-tamper features, designed to be readily portable and hand-emplaced against lightly armored targets. The primary lethal mechanism is an explosively formed penetrator (EFP). The hazardous fragment distance of the EFP is highly dependent on the orientation of the munition and line of fire.

b. The M2 self-neutralizes and the M4A1 self-destructs. Do not attempt to change the setting after the activation lever is pulled. Once the activation lever is pulled, the time/mode on the selector switch is entered into memory and cannot be changed. Physically moving the selector switch after the activation lever is pulled appears to change the setting, but the original setting will remain in the memory.

c. The M3 DAM has one mode of operation, which is by command detonation. The DAM contains explosive but has no battery, electronics, or associated parts including sheer pin activation lever, or passive sensor. Manual warhead initiation is provided using M6 or M7 blasting caps with M1A4 priming adapter.

d. All personnel within 240 m (792 ft) of a detonating SLAM/DAM are required to wear single hearing protection.

e. SDZ for the M2 and M4A1 SLAM and M3 DAM is in figure 15–9. Vertical hazard distance for the EFP is 2,969 m. Distance X is 236 m, except in the direction of the EFP, in which case it is 3,911 m 20 degrees on either side of the anticipated line of travel of the EFP. Personnel outside that 40 degrees cone protected by 3 in of armor may be as close as 100 m to the detonation point.

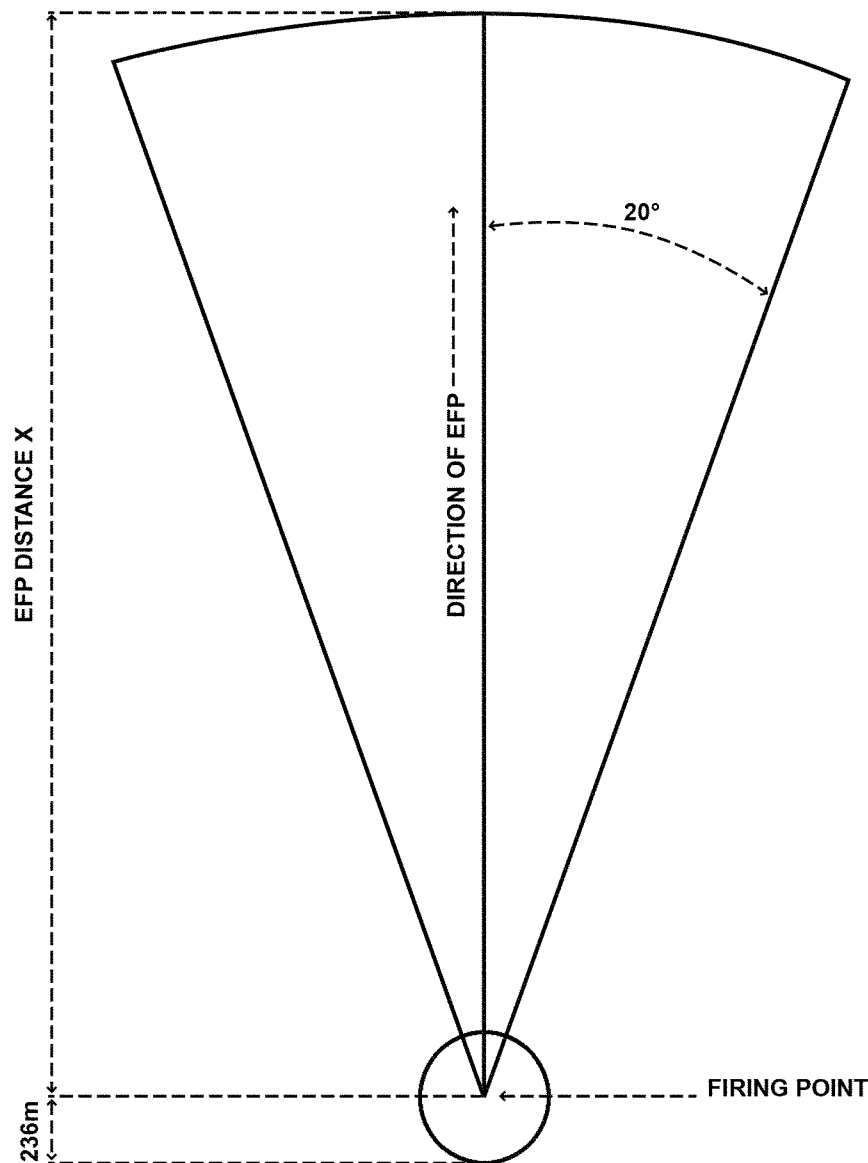

Figure 15-9. Surface danger zone for M2/M4A1 Selectable Lightweight Attack Munition and M3 Demolition Attack Munition

15-14. Rifle Launched Entry Munition and Grenade, Rifle Entry Munition

a. The Rifle Launched Entry Munition (RLEM)/Grenade Rifle Entry Munition (GREM) M100 is a lightweight, muzzle-launched, rifle grenade designed to break down a door and allow the entry into a building or enclosed area with minimum hazard to the operator. The RLEM/GREM is fired from the muzzle of a personal weapon (M16-series rifles and M4-series weapons). It has a bullet trap which allows the use of 5.56mm M855 ball and M856 tracer rounds. The RLEM/GREM is launched by firing a round to a distance of at least 15 m. It has a standoff rod that provides optimal distance for initiation of the explosive charge. A disk on the end of the standoff rod prevents penetration of the rod into the target. The warhead has a plastic cover which eliminates the explosive splashing toward the gunner. The pyrotechnic adapter keeps the explosive away from the tail section, preventing flyback of the tail toward the gunner.

b. The GREM-Target Practice (GREM-TP) M101, is a reusable training device used to train personnel for the GREM. The GREM-TP is externally similar in shape and form to the GREM, but it is nonexplosive. M195 grenade cartridges are used for firing because there is no bullet trap. Each GREM-TP comes with five standoff rods.

c. Tabular data is contained in table 15–7. The SDZ requirements for firing the M100 and M101 are provided in figure 15–10.

d. For personnel within 534 m of device functioning: Army personnel are required to wear approved protective helmets, body armor, eye protection, and single hearing protection. Marine Corps personnel will be in PPE level 1.

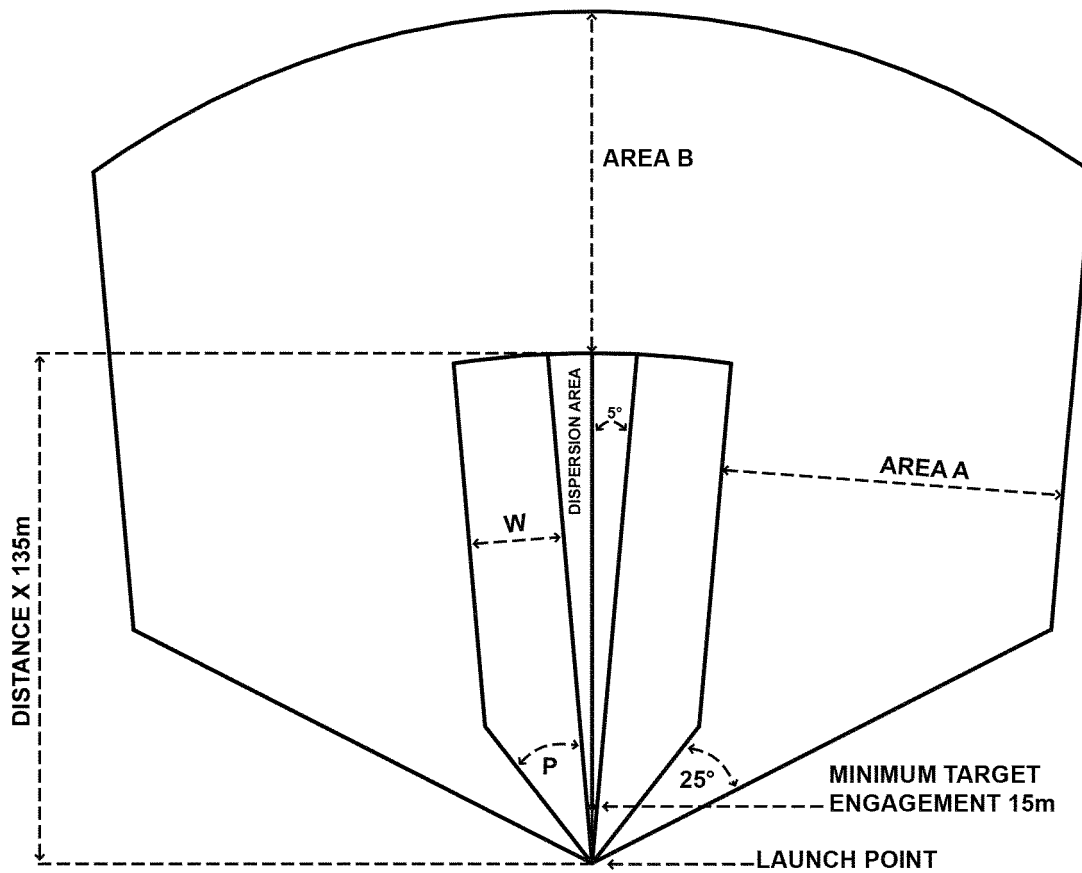

Figure 15–10. Surface danger zone for the Rifle Launched Entry Munition and Grenade Rifle Entry Munition

Table 15–1
Dimensions of sand cushion

Explosives (kg/lbs)	Sand depth (m)	Radius of sand surface (m)
.10/ 0.25	0.6	0.2
.23/ 0.50	1.0	0.3
.45/ 1.00	1.3	0.5
.91/2.00	1.6	0.6
1.9/4.00	2.0	1.0
2.27/5.00	2.3	1.1

Table 15-2
Safe distances for personnel (near bare charges)

Charges	Missile hazard distance (m)
more than 227 kg/more than 500 lbs	Minimum 800
12.27 kg/27 lbs to 227 kg/500 lbs	Computed ¹
less than 12.27 kg/less than 27 lbs	Minimum 300 m ²

Notes:

¹ Computed missile hazard distance in meters=100 times the cube root of the pounds of explosive: $(D=100 \times W^{1/3})$.

² When charges less than five pounds are placed on specially prepared or selected sites (para 15-1f(2)(a)) to eliminate a missile hazard, distance may be reduced to not less than 50 m.

Table 15-3
Hearing protection distances

Weight of explosives		Distance to 140 dBP contour (m)
kg	lb	m
0.10	0.25	145
0.23	0.50	183
0.45	1.00	230
0.91	2.00	290
2.27	5.00	394
4.45	10.00	497
9.10	20.00	626
22.70	50.00	849
45.00	100.00	1,070
91.00	200.00	1,348

Table 15-4
Minimum safe distances between radio frequency transmitters and electric blasting operations

Transmitter power watts	Commercial AM broadcast transmitters (m)	HF transmitter other than AM broadcast (m)
100	229	229
500	229	519
1,000	229	732
4,000	229	1,464
5,000	259	1,678
10,000	397	2,318
25,000	610	3,360
50,000 ¹	854	5,185
100,000	1,190	7,320
500,000 ²	2,684	16,755

Notes:

¹ Present maximum power of U.S. broadcast transmitters in commercial AM broadcast frequency range (535 to 1,605 kHz).

² Present maximum for international broadcast.

Table 15-5
Minimum safe distances between television and FM broadcast transmitters and electric blasting operations

Effective radiative power (watts)	Channels 2 to 6 and FM (m)	Channels 7 to 13 (m)	UHF (m)
Up to 1,000	315	229	183
10,000	549	397	183
100,000 ¹	976	702	336
316,000 ²	1,312	915	442
1,000,000	1,769	1,220	610
5,000,000 ³	2,745	1,891	915
10,000,000	3,111	2,257	1,068
100,000,000			1,803

Notes:

¹ Present maximum power, channels 2 to 6 and FM.

² Present maximum power, channels 7 to 13.

³ Present maximum power, channels 14 to 83.

Table 15–6
Minimum safe distances between mobile RF transmitters and electric blasting operations

Transmitter power	Minimum safe distances				
	Medium frequency, 1.6 to 3.4MHz, industrial	HF, 28 to 29.7MHz amateur	Very high frequency, 35 to 36MHz public use; 42 to 44MHz public use; 50 to 54MHz, amateur	Very high frequency, 144 to 148MHz amateur; 150.8 to 161.6MHz public use; 222 to 225 MHz amateur	Ultra high frequency, 420 to 450MHz, amateur; 450 to 460MHz, public use
watts	m				
5 ¹		2			
10	12	31	12	5	3
50	28	67	28	11	6
100	38	95	40	15	9
180 ²				20	
250	61	150	63	23	14
500 ³			89		
600 ⁴	92	232	96	35	21
1,000 ⁵	122	290	125	46	28
10,000 ⁶	382		397		

Notes:

¹ Citizens band radio (walkie-talkie) (26.96 to 27.41MHz) minimum safe distance is 1.52 m.

² Maximum power for 2-way mobile units in VHF (150.8 to 161.6MHz) range and for 2-way mobile and fixed-station units in UHF (450 to 460MHz) range.

³ Maximum power for major VHF 2-way mobile and fixed-station units in 35 to 44MHz range.

⁴ Maximum power for 2-way fixed-station units in VHF (150.8 to 161.1MHz) range.

⁵ Maximum power for amateur radio mobile units.

⁶ Maximum power for some base stations in 42 to 44 MHz band and 1.8MHz band.

Table 15–7
Surface danger zone criteria for the Rifle Launched Entry Munition and Grenade Rifle Entry Munition (hard and soft targets)

Munition	Distance X (m)	Area W (m)	Angle P (deg)	Area A (m)	Area B (m)
M100	135	25	33	13	13
M101	135	25	33	NR	NR

Chapter 16

Laser Range Safety

16–1. General

The fundamental concept of laser range safety is to prevent direct and collateral injury or damage resulting from laser use. Personnel using or supervising the use of lasers will be thoroughly familiar with all aspects of laser operations, systems employed, and associated dangers during training.

a. Safe use of military lasers and laser systems. This chapter provides guidance for the safe use of military lasers and laser systems on military ranges as listed in MIL–HDBK–828B and JP 3–09.

b. Safe treatment of lasers. Lasers will be treated as direct-fire weapons.

c. Laser systems. Laser systems will be directed only at approved targets and from approved operating positions/ areas or on designated headings and altitudes.

d. Laser usage. Unfiltered Class 3B, 4, or DOD-exempt lasers will be used only on certified laser ranges approved for laser usage in accordance with paragraph 16–3. These lasers will be operated only in restricted airspace.

e. Nominal ocular hazard distance. The nominal ocular hazard distance (NOHD) is the distance from an operating laser to the point where the laser is no longer an eye hazard (for example, the irradiance or radiant exposure during operation is not expected to exceed the appropriate maximum permissible exposure (MPE) level).

f. Unprotected personnel. Unprotected personnel must not be exposed to laser radiation within the NOHD of the laser system.

g. Protected personnel. Personnel within the LSDZ will wear laser eye protection during laser operations. Eyewear must be appropriate for the wavelength and corresponding optical density required of the laser system in use. Skin protection should be worn when appropriate.

h. Aided viewing. Aided viewing involves the use of optical devices including binoculars, scopes, rangefinders, and so forth. The magnification of laser energy can significantly increase the NOHD of the laser. The use of magnifying optical devices to observe the target during laser operation is permitted if specular surfaces have been removed from the LSDZ, appropriate laser filters are used, or it is being viewed beyond the NOHD-magnified. Optical devices not marked with the level of protection at the laser wavelength should be assumed to offer no protection unless verified. Personnel should not deliberately view direct laser radiation with magnifying optical instruments within NOHD-magnified unless the optical devices have the appropriate filtration to limit the exposure to below the MPE level.

i. Optical interrupt laser systems. Optical interrupt (OI) laser systems use intense light to cause visual field obscuration in targeted individuals. OIs are intended to be primarily a warning device, with an inherent and secondary capability to achieve ocular suppression effects as the situation dictates. The OI device should meet stringent safety criteria and be able to deliver a warning effect to targeted personnel by obscuring their vision. The devices currently in use may be Class 3R or greater laser systems that can be safely employed for training. However, due to the intensity of the laser beam, it can pose an eye hazard within the NOHD if incorrectly employed. If exposure distances are known and briefed prior to use which are equal to or less than the NOHD of the system, the OI laser system must be terminated.

j. Backstops. Backstops, natural or manmade, are features downrange from the target which terminate the beam, thus limiting the hazard distance. The optimal use of backstops is key to minimizing laser hazards.

k. Buffer zones. The buffer zone is a conical volume starting at the laser exit port and extending to the backstop or NOHD, expanding over this distance as defined by the divergence of the laser plus buffer angle. The buffer angle depends on the aiming accuracy and stability of the laser device and is usually greater than the divergence. The laser horizontal buffer zone could be partially or completely included in the danger zones of other weapons used on ranges.

l. Laser surface danger zone designation. The LSDZ is the designated region or ground area where laser radiation levels may exceed MPE levels, thereby requiring control during laser operation. When used in conjunction with live-fire weapons, the LSDZ might be more elongated than the SDZ/WDZ if not terminated by an adequate backstop. LSDZs can be generated, either manually or by using the RMTK laser range management tool, to support training plans, map data, information requests, and so forth. This effort includes inputting the laser system and range data (for example, firing points and targets) and performing analysis to mitigate risk to ensure the laser training can be safely conducted on a given operational training range.

m. Hazardous laser output. Unless otherwise specifically authorized, when lasers are not in use, hazardous laser output should be prevented by removing batteries, installing such devices as output covers, or rotating the laser into the stowed position.

n. Laser exit port. The laser exit port must be covered or stowed and the device turned off when not engaged in training. Non-laser operations such as viewing through common optics can be conducted in a non-laser controlled area with the laser exit port cover removed if the laser is turned off.

o. Laser systems modes. When laser systems have both training and combat operating modes, the combat mode will be employed only if safely contained in the laser training range's controlled area. SOPs will enforce this measure.

p. Force-on-force operations. Force-on-force laser operations involve combat simulation, target acquisition, illumination and/or pointing, target designation, weapons guidance, or range-finding against friendly and/or opposing forces. Force-on-force laser tactical exercises are approved on a case-by-case basis, dependent on the scheme of maneuver and risk analysis submitted by the using unit. Tactical exercises involving force-on-force units using laser systems other than the Multiple Integrated Laser Engagement System may require approval by the senior commander (Army)/installation commander (Marine Corps). Only Service-approved laser devices are used in force-on-force tactical exercises. Risk management procedures are completed in accordance with FM 5-19, MCRP 5-12D, and MCO 3500.27B.

16-2. Procedural guidance

The policies and responsibilities for laser usage on ranges and training areas are defined in AR 385-63/MCO 3570.1C. Provided is procedural guidance on how to fulfill those policies and responsibilities.

a. Specific institutional guidance for laser range safety. The institutional laser range authority provides guidance to installations via Service-specific regulations. The institutional laser range authority maintains publications relating to laser use on ranges and establishes or recommends the requirements for training programs. They ensure certification of ranges for laser use in accordance with paragraph 16-3 of this pamphlet.

(1) *Army.* The CG, U.S. Army Public Health Command Nonionizing Radiation Program (MCHB-IP-ONR) provides laser range specific technical expertise to the CG, TRADOC (ATIC-LTR-O) on laser hazards to personnel operating lasers. The U.S. Army Public Health Command expertise includes evaluation of laser systems and recommendations on policies and procedures to limit exposure to lasers on ranges. A non-ionizing radiation protection study by the U.S. Army Public Health Command and a safety confirmation by the Developmental Test Command of the U.S. Army Test

and Evaluation Command should be performed on the laser system prior to use on laser ranges. Non-fielded lasers systems or laser systems not in their original configuration (such as, a laser was fielded for use in a helicopter and now is planned to be mounted on a vehicle), the organization using the laser must obtain a safety release from Developmental Test Command prior to use on the laser ranges.

(2) *Marine Corps*. The CG, MCCDC (C465) is responsible for Marine Corps range safety, of which laser safety is one component. CG, MCCDC (C465) serves as the proponent for all matters pertaining to the oversight and coordination of laser ranges with Marine Corps ranges and training areas. Additionally, CG MCCDC (C465) has overall authority for all Marine Corps laser range management issues in coordination with installations and other Services for laser range requirements.

b. Specific installation guidance for laser range safety. For the Army, the senior/installation commander has the authority to implement policies and procedures for safe laser operations in accordance with technical information provided in MIL-HDBK-828 series and other regulatory guidance. For the Army and Marine Corps, the senior/installation commander normally assigns responsibilities for the following laser range safety procedures to the RMA (Army), RCO (Marine Corps):

(1) Develop SOPs pertaining to laser range safety that include proper controls of hazardous laser radiation. SOPs should include details on laser radiation and other laser related hazards such as releasing guided ordnance that may unintentionally acquire radiation sources within the field of detection other than the target, or lasing an unapproved target. Update SOPs as necessary to account for new laser systems, training areas, and targets.

(2) Review the laser range certification process and range SOP annually or when changes are made.

(3) Use the Range Facility Management Support System to record date, start and stop time for lasing periods, and type of laser or other appropriate information for each laser operation (such as, laser firing log).

(4) Review unit laser training/use plans as part of the range approval process to identify potential deficiencies in the training plan and monitor compliance with safety policies and procedures. Guidelines for unit laser training/use plans are included in this chapter. The installation should ensure the following guidelines have been incorporated into the unit training/use plan.

(a) Laser systems are approved and appropriate for the designated range.

(b) Limits of the LSDZ are properly identified and are contained within the certified laser range area.

(c) Ground personnel locations requiring PPE are identified.

(d) Access to hazardous areas for unprotected personnel is limited.

(e) Targets, laser firing area/line/points, orbit points, and laser-to-target orientation are verified to ensure they can be supported by the laser system and the range.

(f) PPE requirements are verified to ensure they are appropriate for the wavelength and optical density requirements of the laser and weapon systems being used.

(g) Training mode/filter requirements are evaluated and implemented if necessary.

(h) Signs warning of potential laser hazards are at the access points to the laser range.

(i) Emergency response procedures are identified and up to date.

(5) Provide laser briefings and indoctrination on laser operations and testing, to the affected public. The information in the briefing will be at the user level (that is, complex scientific data or terminology will be avoided).

(6) Laser range incident investigations will include:

(a) Review incident in accordance with local SOP and training plan.

(b) Request technical advice on laser capabilities and laser hazard effects.

(c) Gather information about the incident.

(d) Prepare and submit data for the investigation report.

(e) Request unit perform a proper investigation which includes notification of the particular unit's change of command and, for the Marine Corps, the institutional laser range authority.

c. Specific unit level guidance on laser range safety.

(1) Implement the policies and procedures set forth by the installation to ensure safe use of lasers.

(2) Prepare and submit laser training plans for approval to perform laser activities on a specific laser range or training area. A unit laser training plan should include the following factors:

(a) Determine laser operations in support of training requirements.

(b) Review training to be accomplished against local SOPs.

(c) Coordinate to select a range whose laser range certification supports the laser system(s) to be used and training exercise to be accomplished.

(d) Review laser modes/tactics to be employed to ensure they support the laser system and range.

(e) Identify targets, laser firing area/line/points, laser-to-target orientation, and orbit points that can be supported by the LSDZ. The laser must be terminated or the NOHD fully contained within the controlled area of the range.

(f) Identify ground personnel locations.

(g) Identify range hazard concerns (such as, conflicts, impact areas, and clearing requirements).

- (h) Employ risk management in order to identify administrative controls to be implemented by the units.
 - (i) Identify PPE requirements.
 - (j) Identify communications requirements.
 - (k) Review the installation SOP to be aware of local emergency response procedures and laser injury response protocol.
- (3) Range laser safety inspection. The unit conducts laser safety inspections of the range and its operations prior to use and confirm the following areas are covered:
- (a) Laser warning signs are posted.
 - (b) Range configuration is acceptable (targets/backstop, range boundaries, laser firing area/line/points).
 - (c) LSDZ is clear of specular reflectors (this can be conducted via range sweep in accordance with local SOPs).
 - (d) Laser range or training area is clear of non-participating personnel and equipment (this can be conducted via range sweep in accordance with local SOPs).
 - (e) Participating personnel in the area are aware of lasing activities and using appropriate PPE.
 - (f) Laser systems are authorized per the training plan.
 - (g) Training filters/modes are used, as applicable.
 - (h) Communication and terminology are agreed upon with range operations (Army), range control (Marine Corps).
 - (i) Correct any discrepancies prior to training.
- (4) Safety brief/pre-mission brief. The range OIC or laser RSO provides safety briefs/pre-mission briefs to laser range users and observers prior to laser operations. At a minimum, the brief should include as appropriate —
- (a) Laser systems to be used and their purpose (for example, range finding, target acquisition/pointing, designating, or sensor disruption).
 - (b) Control measures specific to the lasers employed and the range upon which they are used.
 - (c) Authorized tactics, laser firing positions (ground and air), laser-to-target orientation, weapons release points, and weapon performance.
 - (d) Drawings, photographs, descriptions or grid points of authorized targets.
 - (e) Communication procedures that include specific frequencies (or channels), controlling authorities, and standardized terminology.
 - (f) Acquisition, identification, and tracking procedures for targets.
 - (g) Missile/ordnance mode of operation.
 - (h) Requirements for beam termination and means to accomplish it.
 - (i) Control measures to minimize the risk of unauthorized personnel, vehicles, or aircraft entering the range area.
 - (j) Run-in headings and flight profiles to be used for airborne laser operations or permissible LSDZ for ground-based laser operations.
 - (k) Review of mission profiles to prevent misdirection of laser guided weapons.
 - (l) Type of eye protection to be worn and description of proper use.
 - (m) Potential hazards posed by the laser system (for example, backscatter, ignition of flammables, sensor disruption, or misdirection of laser guided weapons) and any other associated non-laser hazards.
 - (n) Risk considerations for location of personnel within the SDZ/WDZ for observing/lasing the target area to weapons impact.
 - (o) A review of applicable range SOP information.
- (5) Guidance prior to laser operations. The OIC and laser RSO also perform the following functions in advance of laser operations:
- (a) Review and approve laser systems and targets.
 - (b) Use only approved lasers on the range.
 - (c) Laser systems are used only at the approved operating position or firing points and always pointed toward the target; verify laser firing area/line/points and laser-to-target orientation.
 - (d) Laser systems engage only authorized targets.
 - (e) Target is positively identified in accordance with appropriate safety procedures before operation of a laser system.
 - (f) Ensure all non-participating personnel in the immediate area of the laser firing position are outside the LSDZ.
 - (g) Target area is clear of all non-participating personnel.
 - (h) Supervise pre-fire checks. Pre-fire checks that require operation of the laser system may be made in a controlled area with the laser beam terminated by an approved backstop. Pre-fire checks that do not require operation of the laser, but require use of the optics, may be safely made in any area. To use the optics without firing the laser, follow SOP to ensure power to the laser is turned off.
- (6) General guidance during laser operations includes the following:
- (a) Communications are maintained between the laser system operators, the range operations firing desk (Army), range control (Marine Corps), and all affected range personnel.

- (b) Personnel follow safety procedures in accordance with local SOP.
 - (c) Training filters/modes are used, as required.
 - (d) PPE is used, as required.
 - (e) Approved training plan is followed.
 - (f) Coordinate emergency response, as necessary.
- (7) Cease fire operations. If unsafe conditions are observed laser operations must be stopped. All/any personnel have the responsibility to call a “CEASE FIRE” when appropriate. The following are reasons to cease laser operations:
- (a) Any specular reflection is detected in the target area.
 - (b) Poor target tracking is observed.
 - (c) Non-participating personnel and/or traffic enter the laser range or training area.
 - (d) Loss of communication with the range operations firing desk (Army), range control (Marine Corps).
- (8) Procedures for laser incident investigations include the following actions:
- (a) Ensure laser system involved in the incident is quarantined.
 - (b) Report the incident to the installation laser range authority in accordance with the local SOP and in accordance with paragraph 16–6.
 - (c) Provide information on training activity/exercise, as necessary.
 - (d) Provide information on what happened, where, when, and how.
 - (e) Provide information on personnel who may have been exposed to a laser hazard.
 - (f) Provide the essential parts of the pre-operational briefing.

16–3. Laser range certification

The certification process is the approval of a range or training area for laser usage.

a. Army. The Army does not certify, per se, ranges for laser use. For the purpose of this chapter, the term certification means the approval of a training event where lasers will be employed. This certification/approval is delegated to the installation as a normal part of approving training events on the range complex. The training request, along with the pertinent unit training plan and risk mitigation plan, will be evaluated in accordance with the principles contained in this chapter and the current MIL–HDBK–828 series manual. The RMTK laser range management tool may be used in this process. Questions regarding laser safety in the range complex should be directed to the CG, TRADOC, TCM Ranges (ATIC–LTR–O).

b. Marine Corps.

(1) Certification of Marine Corps laser ranges will be accomplished by a range laser safety specialist or an approved Marine Corps laser range certifier in coordination with CG, MCCDC (C465). Laser ranges will be certified using guidelines contained in MIL–HDBK–828B, MCO 3550.9, and MCO 5104.1C and in conjunction with the RMTK laser range management tool. The certification data will be held on file at the installation range control office and CG, MCCDC (C465) for future reference. Questions regarding laser safety or certification should be directed to the institutional laser range authority.

(2) The installation RCO will assist the institutional laser range authority in performing range certification for the safe use of lasers.

16–4. Laser range design

During the design phase of ranges upon which lasers will be used, the following procedures will be performed in order to ensure safe laser use. For the Army, this is done during site selection by the installation as a preliminary part of the laser range certification process. For the Marine Corps, the institutional laser range authority may be asked to provide input to the design of the range with regard to technical requirements.

- a.* Conduct site analysis to determine range design requirements.
- b.* Determine whether an existing range can be modified or a new range must be established to meet the training requirements.
- c.* Perform risk analysis.
- d.* Provide technical guidance on range design to support safety, mission, and environmental requirements.
- e.* Request technical guidance on construction requirements from the appropriate installation agency.
- f.* Consult the institutional range authority.

16–5. Other safety considerations

a. Laser-guided munitions and other laser detectors may unintentionally acquire radiation sources within the field of detection other than the target. Fields of detection vary and are specific to individual weapons and detectors or sensors. Training will be planned to ensure that the angle between the laser designator line of sight and laser detectors (such as laser-guided munitions or laser-spot trackers) will not allow the munitions to impact on the laser source or scattered radiation from the laser platform.

b. Extreme caution will be taken when using a target designating laser in conjunction with ordnance delivery

aircraft. The potential exists for the laser seeker of the munition to lock onto the designator or its radiated energy (beam or reflected beam) instead of the target. The following procedures will be followed to reduce this risk.

(1) The pilot of the attacking aircraft will confirm the location of the designator and the target before releasing munitions.

(2) Approach paths will be designated and briefed to both the designating and forward air controller personnel and the aircrews prior to conducting the mission. Aircraft approach paths will be planned to preclude crossing laser designator beams with the laser seeker. The laser seeker should intersect the designator beam well forward of the laser firing point, angling toward the target.

(3) Only participating personnel will be within the danger zone of the weapon employed. Additionally, only participating personnel will be located at the designator or close to a direct or reflected beam of the laser designator during operations.

(4) Munitions will not be launched or released toward the laser designator. See applicable TMs, FMs, current MIL-HDBK-828B, and doctrinal publications for recommended employment procedures.

c. NVDs can detect laser energy but they will not be used for laser eye protection. These devices are not "cover-all" goggles; laser energy may enter the eye from offset angles where protection is not afforded. The damage threshold for NVDs may be as low or lower than the damage threshold for the human eye. These devices can be bloomed (white out), damaged, or destroyed from exposure to laser radiation thus creating ancillary safety hazards.

16-6. Laser accident/incident reporting

Report all suspected laser accidents/incidents, regardless of injury, in accordance with AR 385-10, DA Pam 385-24, DA Pam 385-40, TB MED 524, MCO 5104.1C, BUMEDINST 6470.23, and AFI 48-139. The expeditious examination and treatment of laser eye injuries are critical in minimizing loss of visual acuity. Expedient medical guidance is available through the Tri-Service Laser Injury Hotline at 1-800-473-3549 or 937-938-3764, DSN (312) 798-3764, or esoh.service.center@wpafb.af.mil.

Chapter 17 Live-Fire Exercises

17-1. Safety during live-fire exercises

a. Live-fire phases of training exercises are conducted with maximum realism and safety. If safety or terrain limitations do require some unrealistic actions to be taken, personnel should be briefed, in detail, on why artificial actions are required and what the unit would do if confronted with a similar situation in combat.

b. CALFEX (Army)/CAX (Marine Corps) involve the participation of two or more combat arms and/or DOD services. Air and ground weapons shall be used in accordance with current doctrine unless specifically prohibited from use by this pamphlet. Because of the dangers and complexities associated with CALFEXs/CAXs, commanders will thoroughly review training scenarios (scheme of maneuver and fire support) and ensure close coordination among participants. Commanders will apply risk management to all aspects of the CALFEX/CAX.

17-2. Information for commanders

a. Training to permit highly realistic maneuvers and live-fire exercises involves specific personnel safety requirements. Senior commanders (Army)/installation commanders (Marine Corps) will publish specific range guidance (for example, range regulations, SOPs, and so forth) that applies specifically to their installations. This guidance will define safety requirements to support live-fire training exercises. Directives developed for a particular location are not authorized for use at a different location.

b. Commanders whose units participate in live-fire exercises will —

(1) Make certain that all individual gunners who will take part in live-fire exercises, including fighting vehicle, tank, and aviation gunners, have fired and passed a qualification course for the weapon or system they will fire in the exercise.

(2) Conduct rehearsal (dry run) exercises prior to the live-fire and maneuver exercise. The commander will assess the proficiency and experience level of their unit and the degree of risk involved to determine the scope and duration of the rehearsal and if it should be executed on the same range on which the live-fire and maneuver training will be conducted. The rehearsal should be scheduled as close to the actual event as is feasible to retain individual situational awareness and skills. Additionally, whenever feasible, rehearsals will replicate as closely as possible the conditions involved in the actual event. Such conditions should include, but are not limited to, time of day, similar terrain, and the status of the personnel (that is, uniforms, equipment, and camouflage). In addition, rehearsals will include a review of range safety requirements for the live-fire and maneuver range. The review should include, but is not limited to, lateral limits, danger zones for weapons and AE used, air limitations and restrictions, both for live-fire and medical evacuation, and emergency and/or casualty evacuation procedures. For the Army, the CG, U.S. Army Special Operations Command, may approve deviation from this requirement for Army Special Operations Forces. If Army Special

Operations Forces are training on a non- U.S. Army Special Operations Command installation, host senior commander concurrence is required.

(3) Orient participants on the capabilities of the weapons used by other components in the CALFEX/CAX.

(4) Designate individuals (such as observer-controllers) who are not part of the tactical or administrative scheme to monitor safety. These individuals will maintain visual contact with maneuvering elements and should have some means of signaling a cease-fire. Communications with the tactical operations center is mandatory.

c. For battalion/squadron or larger exercises, a field grade commissioned officer will be appointed as the exercise OIC.

d. For the Marine Corps, the commander will assess the proficiency and experience level of their unit in determining the quantity of observers-controllers (that is, ARSOs) required for the event. Other factors influencing this decision should include, but are not limited to, the scheme of maneuver, geometry of the attack, composition of forces, dispersion of forces, visibility, weather conditions, and fatigue. Marine Corps observers-controllers report to the exercise RSO, and will have training in local range safety procedures and SDZ employment.

17-3. Exercise planning

a. Units will conduct live-fire exercises in support of properly identified and trained-to-standards mission essential task list (METL) tasks. Tactics, techniques, and procedures employed during the live-fire exercises must be consistent with the standards published in the applicable Army Training and Leader Development Strategy mission training plan and/or battle drills. Command approval from the next higher command is required for any live-fire exercise not consistent with the unit's established METL.

b. Detailed written plans will be developed between the RMA (Army), RCO (Marine Corps) and the exercise OIC. It will require submission of formal risk management documentation prior to execution. For the Army, if residual risk is extremely high, approval is required by the ACOM/ASCC/DRU commander or designated official in accordance with risk decision authority (DA Pam 385-30). The garrison safety manager will review the completed plan and risk management documentation that will include:

- (1) A detailed plan of maneuver and fire support.
- (2) A list of weapons, AE (for example, ammunition, pyrotechnics, or smokes), and chemicals to be used.
- (3) Unit control measures, including means of communication.
- (4) Terrain feature and facilities required.
- (5) Emergency action plans. Include, as appropriate, the need for emergency equipment such as litters or fire extinguishers, prepositioning of emergency responders, and coordination with medical treatment facilities.

c. Impact distance and limits of advance are as follows:

(1) The distances to which unprotected troops can safely move near the impact are (that is, Areas A, B and C) indicated in the chapter on each weapon or weapons system.

(2) To determine how close unprotected troops may maneuver to the target area, an impact area and a danger zone must be established for each target area used. Danger zones must be computed and issued to leaders and safety personnel before starting the exercise. When several types of weapons are being fired into one target area, the combined total danger zone (composite danger zone) will govern. These restrictions normally should not preclude unit commanders from selecting tactically sound supporting weapon positions for their scheme of maneuver, provided the positions and directions of fire do not exceed the total range area available for the exercise. When feasible, leaders and safety personnel will be shown the physical limits of the danger zone by ground survey.

(3) The short limit of the impact area may be moved in the direction of the target area by definite pre-arrangement to permit forward movement of troops.

(4) Demolitions may be used during live-fire exercises according to chapter 15.

(5) Selection of weapon positions will be the responsibility of unit leaders taking part in the exercise.

(6) Terrain will be used to enhance safety features when it is being selected for live-fire exercises involving overhead and/or flanking fire.

d. During live-fire exercises planning, the risk management process must address possible hazards from friendly fire and control measures to reduce or eliminate them, while executing the METL task to published standards.

e. A review of lessons learned may provide beneficial information to identify and mitigate risks (for example, U.S. Army Combat Readiness/Safety Center Web site, Army Lessons Learned Web site).

17-4. Firing precautions

a. Overhead fire of personnel may be authorized, provided they have positive protection from the munitions being fired. Protected positions for personnel and vehicles are discussed in ATP 3-37.34.

b. The senior commander (Army)/installation commander (Marine Corps) (or designated representative) can authorize overhead fire above unprotected personnel except for specifically prohibited weapon systems.

c. Weapons specifically authorized for overhead fire of unprotected personnel are:

- (1) All artillery cannon firing indirect fire. See chapter 10 for safety precautions.

(2) Machine-guns (5.56mm, 7.62mm, and .50 caliber) on ground tripods or vehicle mounts (ring mounts excluded) firing from a stationary position.

d. Only ammunition certified for overhead fire will be used.

e. All firing of direct-fire weapons will be from positions that provide an unobstructed field of fire.

f. Overhead fire with machine guns in live-fire exercises will be as follows:

(1) Bullets will not be permitted to impact between the firing position and the rear of the line of unprotected personnel. All impacts should be a minimum of 50 m beyond the forward line of unprotected personnel.

(2) Positive stops must be used to prevent crossfire and depression of the muzzle during firing.

(3) A minimum clearance or safety limit must be established using the guidelines for overhead fire in FM 3–22.65 and FM 3–22.68. Marine Corps personnel use Marine Corps Warfighting Publication 3–15.1.

(4) The rate of fire will not exceed 70 rounds per minute for 5.56mm and 7.62mm machine guns and 40 rounds per minute for .50 caliber machine guns.

(5) Weapons will be test fired before delivery of overhead fire to verify effectiveness of the positive traverse and depression stops.

(6) Tracer ammunition may be used as a check to track the projectile flight path.

g. In addition to the requirements of paragraph *f*, the following precautions will apply to overhead fire with machine guns for a confidence infiltration course:

(1) Firing will be from approved platforms as described in TC 3–21.75.

(2) Qualified field maintenance/ordnance personnel will inspect the mounts and weapons before being declared safe to deliver overhead fire.

(3) A minimum clearance of 2.5 m over the heads of personnel or the highest obstruction within the field of fire will be maintained. Minimum clearance is the distance between the lowest shot in the dispersion pattern (as determined by the test firing) and the bodies of individuals in erect positions on the highest point of ground, log, or other obstacle over which personnel must travel, or heights of barbed wire strands or posts on the course, whichever is higher.

h. All firing of indirect fire weapons will be from positions in which the site to mask allows engagement of the targets nearest to the forward line of troops. Selection of firing positions, direction of fire, and fall of shot must prevent the projectiles from striking trees or other obstacles in the area from the weapon position to a point forward of unprotected personnel. The forward point is defined as the bursting radius of the round, plus 12 range probable errors.

i. When field artillery is fired during CALFEX/CAX with maneuvering personnel, the impact area will be adjusted according to the maneuver location of troops to maintain safe separation distance. The troop side of the impact area will be determined in relation to the movement of the personnel. Unprotected troops must not be permitted to enter danger zones after firing has commenced.

j. Weapons will be grouped by muzzle velocity as cited in FM 6–40 or pertinent Marine Corps TMs. Weapons will be bore-sighted as prescribed in FM 6–50. Tubes will be clean and dry before start of exercise and will be cleaned during the exercise in accordance with appropriate weapon TMs.

k. All ammunition to be fired should be uniformly conditioned to ambient temperature consistent with the tactical situation.

l. Registration.

(1) At least two rounds should be fired for registration. Targets should be selected in the central portion of the target area. After registration, corrections must be applied to deflection and quadrant elevation limits. If no registration is fired, meteorological and velocity error (MET + VE) corrections will be applied immediately before the exercise starts.

(2) To compensate for drift in high-angle fire, the right deflection limit will be moved to the left by the amount of the maximum drift listed within the range limits for the charges being fired. The left limit will be moved to the right by the amount of the minimum drift listed within the range limits for the charges being fired. To determine the appropriate drift, the tabular firing table and graphical firing scale must be examined and the safer value used. If a drift value is not listed in the tabular firing table or on the graphical firing scale for the ranges to the near and far edge of the target area, the nearest safer value will be used.

m. Overhead fire above unprotected personnel from a moving vehicle or aircraft is prohibited.

n. Cannon and mortar flanking fire must not impact any closer to unprotected personnel than the fragmentation radius (Area A) prescribed for each weapon.

o. Small arms (5.56mm, 7.62mm, and .50 caliber), ground-mounted or vehicle-mounted machine guns may be fired at low angles of elevation (near the flank of an individual or unit). For the SDZ, there must be an angle of 15 degrees or 100m (whichever is greater) between the limit of fire and the near flank of the closest individual or unit and all impacts are beyond the individual or unit. For the batwing SDZ, all non-participating personnel must be outside of the SDZ. Tripod, traversing and depression stops will be used on machine guns to maintain the required angle and distance between the line of fire and the near flank of an individual or unit.

p. Range SOPs will address firing and maneuver unit locations to ensure no unprotected personnel are exposed to training fires.

17-5. Fire control

The unit commander makes the final decisions on fire control measures. The following conditions must be met:

a. The ammunition in (1) through (7) below may be authorized for use in live-fire exercises only when it is fired into designated (dedicated high hazard) impact areas through which personnel are not permitted to maneuver.

- (1) 40mm HE.
- (2) 66mm light antitank weapon (HE).
- (3) Hand grenades (HE), except as noted in paragraph 17-5*d*.
- (4) MAAWS (HE and HEAT).
- (5) 25mm (HE).
- (6) M74 66mm TPA.
- (7) HE ICM munitions (Marine Corps).

b. Final coordination lines must be identified to all participating units.

c. Weapons used in live-fire exercises will be controlled so that danger zones do not overlap areas in which unprotected personnel are maneuvering.

d. A RSO will directly supervise and control the throwing of fragmentation grenades. The following procedures apply:

(1) Hand fragmentation grenades may be thrown during live-fire exercises. Hand grenades will be carried in accordance with FM 3-23.30. The fragmentation characteristics of the grenades must be considered and appropriate safety precautions taken to include the following:

- (a)* Impact areas will be free of obstacles (such as trees, thick vegetation, tank hulls, deep snow, or standing water).
- (b)* A minimum side-to-side distance of 5 m between each individual during the throwing exercise is required.
- (c)* Throwing positions will protect the throwers from fragments.
- (d)* EOD personnel will destroy dud grenades in place or safe and remove before troops enter the grenade impact area. If EOD personnel are unable to locate or destroy any dud grenades, troop maneuver through the impact area is not authorized.

(2) Individuals being transported by vehicle or aircraft will not carry fragmentation, offensive, or WP grenades attached to web equipment.

17-6. Maneuver in temporary impact areas

a. The senior commanders (Army)/installation commanders (Marine Corps) may approve maneuver through temporary impact areas containing unexploded munitions, except those identified in paragraph 17-5*a*.

b. The senior commanders (Army)/installation commanders (Marine Corps) may approve maneuver through temporary impact areas after reviewing a risk assessment and accepting residual risks. The following munitions, although not identified in paragraph 17-5*a*, may present high or extremely high risk if present.

- (1) .50 caliber SLAP M903.
- (2) 20mm HE.
- (3) 30mm HE.
- (4) All HEAT ammunition because of type of fuze action and sensitivity.
- (5) All ordnance fuzed with mechanical time fuzes.

17-7. Air support

a. During live-fire exercises, the following control measures are required prior to firing aircraft-mounted weapons or dropping air-delivered ordnance:

- (1) Positive identification of personnel locations.
- (2) Positive identification of the target(s).
- (3) Positive clearance to drop/fire ordnance as given by the controlling ground or airborne forward air controller (Marine Corps).
- (4) Approved abort procedures and locations to drop unexpended bombs when necessary.
- (5) Attack flight paths, location of bomb safety lines, and access corridors will be known and visually verified by ground personnel and participating aircrews.
- (6) Direct communications will be established and maintained between the OIC, the forward air controller, and the fire support coordination center that coordinates the direct support artillery fire in the vicinity of an air strike.
- (7) Minimize danger to attacking aircraft from ricochet of ground-fired HE projectiles, and ceasing fire of flat trajectory weapons in the vicinity of air targets under attack within the SDZ (see chap 4 for vertical hazard distances).
- (8) Firing across, within, or through access corridors will not be permitted without coordination with the forward air controller.

(9) Close air support conducted by Marine Corps FW and RW aircraft will be conducted in accordance with appropriate TMs, MAWTS-1 publications, training and readiness manuals, and squadron SOPs.

b. Fire support by Air Force FW aircraft will be conducted in accordance with AFI 13-212.

Appendix A References

Section I Required Publications

Unless otherwise stated, all publications are available at <http://www.apd.army.mil/>.

AR 75-1

Malfunctions Involving Ammunition and Explosives (RCS CSGLD-1961(MI)) (Cited in paras 2-10*b*, 2-10*c*(3), 10-3*c*(1).)

AR 75-15

Policy for Explosive Ordnance Disposal (Cited in para 15-1*b*(2).)

AR 95-1

Flight Regulations (Cited in para 13-2*d*.)

AR 95-2

Airspace, Airfields/Heliports, Flight Activities, Air Traffic Control, and Navigational Aids (Cited in paras 2-4*c*, 2-5*g*(3).)

AR 95-27

Operational Procedures for Aircraft Carrying Hazardous Materials (Cited in para 13-2*d*.)

AR 385-10

The Army Safety Program (Cited in paras 2-12*e*(6)(a), 16-6.)

AR 385-63

Range Safety (Cited in paras 1-1, 1-4*a*, 2-3*a*(1), 3-3*b*, 7-2*b*(6), 11-8*a*(4), 12-6, 14-2*c*, 16-2.)

AR 405-80

Management of Title and Granting Use of Real Property (Cited in para 2-3*a*(4).)

DA Pam 385-11

Army Guidelines for Safety Color Codes, Signs, Tags, and Markings (Cited in para 2-2*a* and *g*.)

DA Pam 385-24

The Army Radiation Safety Program (Cited in para 16-6.)

DA Pam 385-30

Mishap Risk Management (Cited in paras 2-12*b*(4)(c) and (d), 2-12*d*(1), 4-1*c*, 17-3*b*.)

DA Pam 385-40

Army Accidents Investigations and Reporting (Cited in paras 2-10*b*, 16-6.)

DA Pam 385-64

Ammunition and Explosives Safety Standards (Cited in paras 2-10, 2-10*a*, 2-10*a*(2)(a)(3), 15-1*b*(1).)

ATP 3-09.60

Techniques for Multiple Launch Rocket System (MLRS) and High Mobility Artillery Rocket System (HIMARS) Operations (Cited in paras 10-12*b*(1), 10-13*c*(7).)

ATP 3-37.34

Survivability Operations (Cited in para 17-4*a*.)

ATTP 3-06.11

Combined Arms Operation in Urban Terrain (Cited in para 6-1*b*(7).)

BUMEDINST 6470.23

Medical Management of Non-Ionizing Radiation Casualties (Cited in para 16–6.) (Available at <https://rtam.telecom.usmc.mil/>) (Registration and a common access card (CAC)-enabled computer are required.)

DODI 1100.22

Policy and Procedures for Determining Workforce Mix (Cited in para 1–5a.) (Available at <http://www.dtic.mil/whs/directives/>.)

DODI 3200.16

Operational Range Clearance (Cited in para 2–10c(4).) (Available at <http://www.dtic.mil/whs/directives/>.)

FM 3–04.111

Aviation Brigades (Cited in para 2–10a(2)(b).)

FM 3–04.140

Helicopter Gunnery (Cited in paras 11–2c(2), 11–3e, 11–4e(1), 11–5b(1)(b), 11–11b(2)(a).)

FM 3–22.68

Crew Served Weapons (Cited in para 17–4f(3).)

FM 3–34.214

Explosive and Demolitions (Cited in paras 15–1b(1), 15–1f(1), 15–1f(5), 15–1i(1)(a), 15–10e(2), 15–10f.)

FM 4–25.11

First Aid (Cited in para 5–1c(7).)

FM 5–19

Composite Risk Management (Cited in paras 11–8a(4), 11–8c(2), 16–1p.)

FM 6–40

Tactics, Techniques, and Procedures for Field Artillery Manual Cannon Gunnery (Cited in paras 10–9a(4), 17–4j.)

FM 6–50

Tactics, Techniques, and Procedures for the Field Artillery Cannon Battery (Cited in para 17–4j.)

FM 10–67–1

Concept and Equipment of Petroleum Operations (Cited in para 2–10a(2)(b).)

MAWTS–1

Aerial Gunnery Manual (Available from Commanding Officer, Marine Aviation Weapons and Tactics Squadron One, Marine Corps Air Station, Yuma, AZ 85369.) (Cited in paras 11–4e(1), 11–4g(2)(a), 17–7a(9).)

MCBul 8011

Class V(W) Materiel Allowance For Training and Security (Cited in para 10–11a(2).) (Available at <http://www.mccdc.marines.mil/>.)

MCO 3500.27B

Operational Risk Management (ORM) (Cited in paras 11–8a(4), 11–8c(2), 14–2c, 16–1p.) (Available at www.marines.mil/.)

MCO 3570.1C

Range Safety (Cited in paras 1–1, 1–4a, 2–3a(1), 3–3b, 7–2b(6), 11–8a(4), 12–6, 14–2c, 16–2.) (Available at <http://www.marines.mil/>.)

MCO 5104.1C

Navy Laser Hazards Control Program (Cited in paras 16–3b(1), 16–6.) (Available at <http://www.marines.mil/>.)

MCO P5102.1B

Navy and Marine Corps Mishap and Safety Investigation Reporting and Record Keeping Manual (Cited in para 2–10b.) (Available at <http://www.marines.mil/>.)

MCO P8011.4H

Table of Allowances for Class V(W) Material Peacetime (Cited in para 10–11a(2).) (Available at <http://www.marines.mil>.)

MCO 8025.1E

Class V (W) Malfunction and Defect Reporting (Cited in paras 2–10a(2)(d), 2–10b, 2–10c(3), 10–3c(1).) (Available at <http://www.marines.mil>.)

MCRP 3–1.6.24

Tactics, Techniques, and Procedures for Multiple Launch Rocket System (MLRS) Operations (Cited in paras 10–12b(1), 10–13c(7).) (Available at <http://www.marines.mil>.)

MCRP 5–12D

Organization of the Marine Corps Forces (Cited in paras 14–2c, 16–1p.) (Available at <http://www.marines.mil>.)

MIL–HDBK–828B

Range Laser Safety (Cited in paras 11–10f, 16–1a, 16–3b(1), 16–3a, 16–5b(4).) (Available at http://www.assistdocs.com/search/search_basic.cfm.)

MIL–STD 709D

Ammunition Color Coding (Cited in para 17–7a(1).) (Available at <http://dodssp.daps.mil>.)

NAVAIR TM 11–75–63

Launchers, Single Bay LMU-23/E and Power Bay LMU-24E for Smokey Sam (Cited in para 15–11c.) (Available at <https://nossa.nmci.navy.mil/>.) (Registration and a CAC-enabled computer are required.)

NAVSEA OP5 (Including Volume 1)

Ammunition and Explosives Safety Ashore (Cited in paras 1–5g(2), 2–10, 2–10a, 2–10a(2)(a)3, 15–1b(2).) (Available at <https://nossa.nmci.navy.mil/>.) (Registration and a CAC-enabled computer are required.)

NAVSEA SWO60–AA–MMA–010

Demolition Materials (Cited in paras 1–5g(2), 15–1b.) (Available at <https://nossa.nmci.navy.mil/>.) (Registration and a CAC-enabled computer are required.)

NAVSUP P–801

Ammunition Unserviceable, Suspended and Limited Use (Cited in paras 2–10a(2)(c), 2–10b, 2–10b(1), 2–10b(2).) (Available at <https://nossa.nmci.navy.mil/>.) (Registration and a CAC-enabled computer are required.)

NEHC TM 6290.99–10

Indoor Firing Ranges Industrial Hygiene Technical Guide (Cited in para 2–8a.) (Available at http://www-nehc.med.navy.mil/downloads/IH/indoor_firing_range.pdf.)

OPNAVINST 3770.2K

Airspace Procedures and Planning Manual (Cited in para 2–4c.) (Available at <http://doni.daps.dla.mil/>.)

TB MED 524

Control of Hazards to Health from Laser Radiation (Cited in para 16–6.)

TB 9–1300–385

Munitions Restricted or Suspended (Cited in paras 2–10b, 2–10b(1), 2–10b(2).) (Available at <https://mhp.redstone.army.mil>.)

TB 9–1310–251–10

Operator’s Manual Range Clearing Procedures for Cartridge 40MM: TP, M918 (Cited in para 5–2b(9).) (Available from https://www.logsa.army.mil/etms/find_etm.cfm.)

TB 3–1365–490–10

Smoke Pot, HC, 10-lb., M1 and 30-lb., ABC–M5; Smoke Pot, Floating, HC, M4A2; SGF2, AN–M7A1; and Smoke Pot, Floating, MK7MOD0 and Smoke Pot, Floating, Screening, TA, Practice, M8 (Cited in para 13–4d.) (Available from https://www.logsa.army.mil/etms/find_etm.cfm.)

TC 1-600

Unmanned Aircraft System Commander's Guide and Aircrew Training Manual (Cited in para 11-5b(1)(b).)

TC 3-04.11

Commander's Aircrew Training Program for Individual, Crew, and Collective Training (Cited in paras 11-2c(2), 11-3e.)

TC 3-04.35

Aircrew Training Manual, Utility Helicopter, Mi-17 Series (Cited in para 11-3e.)

TC 3-21.75

The Warrior Ethos and Soldier Combat Skills (Cited in para 17-4g(1).)

TC 3-22.23

M18A1 Claymore Munition (Cited in para 15-7c(1)(g).)

TC 3-23.30

Grenades and Pyrotechnic Signals (Cited in paras 5-1a, 5-1c(7), 17-5d(1).)

TC 25-8

Training Ranges (Cited in paras 2-2g, 5-1a, 5-1e(2), 11-3e.) (Available at <http://www.marines.mil>.)

TM 08655A-10A

Light armored vehicle-mortar variants (Cited in para 9-11.) (Available at <http://www.marines.mil>.)

TM 3-23.25

Shoulder-Launched Munitions (Cited in para 6-1a(1).)

TM 9-1300-200

Ammunition, General (Cited in para 15-7a.) (Available from https://www.logsa.army.mil/etms/find_etm.cfm.)

TM 9-1330-200-12

Operator's and Organizational Unit Maintenance Manual for Grenades (Cited in para 5-1c(4).) (Available at <http://www.logsa.army.mil>.)

TM 9-1345-203-12

Operator's and Unit Maintenance Manual for Land Mines (Cited in para 15-8g.) (Available from [https://www.logsa.army.mil/.](https://www.logsa.army.mil/))

TM 9-1370-207-10

Pyrotechnic Simulators (Cited in para 15-10b and c.) (Available from [https://www.logsa.army.mil/.](https://www.logsa.army.mil/))

TM 43-0001-28

Army Ammunition Data Sheets for Artillery Ammunition: Guns, Howitzers, Mortars, Recoilless Rifles, Grenade Launchers and Artillery Fuzes (Federal Supply Class 1310, 1315, 1320, 1390) (Cited in paras 9-11, 10-3d.) (Available at [http://www.logsa.army.mil/.](http://www.logsa.army.mil/))

TM 43-0001-29

Army Ammunition Data Sheets for Grenades (Cited in para 5-1c(4).) (Available at [http://www.logsa.army.mil/.](http://www.logsa.army.mil/))

USAF AFI 13-212

Range Planning and Operations (Cited in para 17-7b.) (Available at [http://afpubs.hq.af.mil/.](http://afpubs.hq.af.mil/))

29 CFR 1910.1025

Occupational Safety and Health Regulations for Lead (Cited in para 2-7a(1).)

29 CFR 1926.200b

Safety and Health Regulations for Construction: Accident Prevention Signs and Tags-Signs, Signals, and Barricades (Cited in para 2-2a.) (Available at [http://www.access.gpo.gov/.](http://www.access.gpo.gov/))

33 CFR 334

Danger Zone and Restricted Area Regulations (Cited in para 2-6a, b, and c.) (Available at <http://www.access.gpo.gov/>.)

Section II

Related Publications

A related publication is a source of additional information. The user does not have to read it to understand this publication. Unless otherwise stated, all publications are available at <http://www.apd.army.mil/>.

AR 15-6

Procedures for Investigating Officers and Boards of Officers

AR 25-30

The Army Publishing Program

AR 40-5

Preventive Medicine

AR 40-10

Health Hazard Assessment Program in Support of the Army Acquisition Process

AR 200-1

Environmental Protection and Enhancement

AR 360-1

The Army Public Affairs Program

AR 405-90

Disposal of Real Estate

DA PAM 40-501

Hearing Conservation Program

AFI 48-139

Laser and Optical Radiation Protection Program (Available at <http://www.e-publishing.af.mil/>.)

ANSI Z136.1

American National Standard for Safe Use of Lasers (Available from <http://webstore.ansi.org/>.)

CTA 50-900

Clothing and Individual Equipment (Available at <https://webtaads.belvoir.army.mil/usafmsa>.)

DODD 3000.03E

DOD Executive Agent for Non-Lethal Weapons (NLW), and NLW Policy (Available at <http://www.dtic.mil/whs/directives/>.)

DODD 5030.19

Military Airspace and Air Traffic Service Functions (Available at <http://www.dtic.mil/whs/directives/>.) Department of Health, Education, and Welfare Publication Number 76-130 (Publication PB 266-426). Lead Exposure and Design Considerations for Indoor Firing Ranges, Technical Information, December 1975, National Institute for Occupational Safety and Health (NIOSH) (Available at National Technical Information Service, (800) 553-6847.)

FM 3-20.12

Tank Gunnery (Abrams)

FM 3-20.21

Heavy Brigade Combat Team (HBCT) Gunnery

FM 3-22.65

Browning Machine Gun, Caliber .50, HB, M2

FM 3-34.210

Explosive Hazards Operations

FM 4-30.51

Unexploded Ordnance (UXO) Procedures

FM 23-65

Browning Machine Gun, Caliber .50 HB, M2

FAA Handbook 7400.2

Procedures for Handling Airspace Matters (Available from www.faa.gov/.)

Federal Acquisition Regulations Subpart 7.5

Inherently Governmental Functions (Available at http://www.acquisition.gov/far/html/Subpart%207_5.html.)

JP 3-09

Joint Fire Support

Marine Corps TM 1185-14/1

Operation, Organizational, and Intermediate Maintenance Instructions with Illustrated Parts Breakdown (Smoky Sam Simulator/Antiaircraft Artillery Visual Cueing System) (Available at http://www.logcom.usmc.mil/sp_logon/, access request required for site access..)

Marine Corps TM 1185-14/2

Loading and Firing Checklist for LMU-23A/E Single Bay Launcher (Available at http://www.logcom.usmc.mil/sp_logon/, access request required for site access.)

Marine Corps TM 1290-12/1

Operators' Manual-Simulator Laser Target (AN/GVT-1) (Available at http://www.logcom.usmc.mil/sp_logon/, access request required for site access.)

MCO 3574.2J

Entry Level and Sustainment Level Marksmanship Training with the M16A2 Service Rifle and M9 Service Pistol (Available at www.marines.mil.)

MCO 8011.4

USMC Training Ammunition Class V (W) Materiel (Peacetime) (Available at www.marines.mil.)

MCO 8027.1D

Interservice Responsibilities for Explosive Ordnance Disposal (Available at www.marines.mil.)

MCO P4030.19K

Preparing Hazardous Materials for Military Air Shipments (Available at <http://www.marines.mil>.)

MCO P8020.10B

Marine Corps Ammunition Management and Explosives Safety Policy Program (Available at <http://www.marines.mil>.)

MCWP 3-15.1

Machines Guns and Machine Gun Gunnery (Available at <http://www.marines.mil>.)

NAVSEA SW020-AF-HBK-010

Motor Vehicle Driver and Shipping Inspector's Manual for Ammunition, Explosives and Related Hazardous Materials (Available at <https://nossa.nmci.navy.mil/>.) (Registration and a CAC-enabled computer are required.)

SPAWAR INST 5100.12B

Navy Laser Hazards Control Program (Available at <https://nossa.nmci.navy.mil/>.) (Registration and a CAC-enabled computer are required.)

Technical Paper 18

Minimum Qualifications for Unexploded Ordnance (UXO) Technicians and Personnel (Available at <https://www.ddesb.pentagon.mil/documents/TechnicalPapers.aspx>.)

TM 9-1375-213-12

Operators and Unit Maintenance Manual (Including Repair Parts and Special Tools List) Demolition Materials (Available from <https://www.logsa.army.mil/>.)

TM 9-6920-361-13&P

Operator, Organizational, and Direct Support Maintenance Manual (Including Repair Parts and Special Tools List) Field Artillery Trainer Kits (With Field Artillery Trainer M31) (Available from <https://www.logsa.army.mil/>.)

TM 43-0001-27

Army Ammunition Data Sheets Small Caliber Ammunition (FSC 1305) (Available from <https://www.logsa.army.mil/>.)

TM 43-0001-30

Army Ammunition Data Sheets for Rocket Systems, Rocket Fuzes, Rocket Motors (FSC 1340) (Available at https://www.logsa.army.mil/etms/find_etm.cfm.)

TM 43-0001-36

Army Ammunition Data Sheets for Land Mines (FSC 1345) (Available from <https://www.logsa.army.mil/>.)

TM 43-0001-37

Army Ammunition Data Sheets for Military Pyrotechnics (FSC 1370) (Available from <https://www.logsa.army.mil/>.)

TM 43-0001-38

Army Ammunition Data Sheets for Demolition Materials (Available from <https://www.logsa.army.mil/>.)

TM 60-series publications

Explosive Ordnance Disposal Technical Manuals (Commander, U.S. Army EOD Technical Detachment, 2008 Stump Neck Road, Indian Head, MD 20640-5096.)

21 CFR 1040

Performance Standards for Light-Emitting Products (Available from <http://ecfr.gpoaccess.gov/>.)

29 CFR 1910

Occupational Safety and Health Standards (Available from www.access.gpo.gov/.)

33 CFR 334.10

Navigation and Navigable Waters (Available from <http://ecfr.gpoaccess.gov/>.)

40 CFR 260

Environmental Protection Agency, Military Munitions Rule: Hazardous Waste Identification and Management; Explosives Emergencies; Manifest Exemption for Transport of Hazardous Waste on Right-of-Ways on Contiguous Properties; Final Rule (Available from www.access.gpo.gov/.)

Section III**Prescribed Forms**

Unless otherwise indicated, DA forms are available on the Army Publishing Directorate Web site at <http://www.apd.army.mil/>.

DA Form 5687

Initial Inspection Checklist for Indoor Ranges (Prescribed in para 2-7d(1).)

DA Form 5688

Detailed Inspection Checklist for Indoor Ranges (Prescribed in para 2-7d(2).)

Section IV
Referenced Forms

DA Form 2028
Recommended Changes to Publications and Blank Forms

Glossary

Section I Abbreviations

ACOM

Army commands

AGL

above ground level

AMC

U.S. Army Materiel Command

AP

armor piercing

APERS

anti-personnel

API

armor-piercing incendiary

AR

Army Regulation

ARSO

assistant range safety officer

ASCC

Army Service component command

ASP

ammunition supply point

ATC

air traffic control

ATWESS

anti-tank weapons effect signature simulator

AT&A

air traffic and airspace officer

BFA

blank firing adapter

CAC

common access card

CALFEX

combined arms live-fire exercise

CBRN

chemical, biological, radiological, and nuclear

CCMCK

close combat mission capability kit

CFA

controlled firing area

CFR

Code of Federal Regulations

CG

commanding general

cm

centimeter

CoRA

Certificates of Risk Acceptance

CS

0-chlorobenzyl denemalononitrite

CVC

combat vehicle crewman

DA

Department of the Army

DDESB

Department of Defense Explosives Safety Board

DDI

drill, dummy, and inert

DES

demolitions effects simulators

DOD

Department of Defense

DODD

Department of Defense directive

DODI

Department of Defense instruction

DODIC

Department of Defense identification code

DRU

direct reporting unit

DU

depleted uranium

DZ

drop zone

EFP

explosively formed penetrator

EOD

explosive ordnance disposal

FAA

Federal Aviation Administration

FIST

fire support team

FM

field manual

ft

feet

FW

fixed wing

GTL

gun target line

GS

general schedule

HC

hexachloroethane

HE

high explosive

HEAT

high-explosive anti-tank

HEDP

high-explosive dual-purpose

HEP

high-explosive plastic

HIMARS

High Mobility Artillery Rocket System

HMMWV

high-mobility multipurpose wheeled vehicle

IBA

improved body armor

ICM

improved conventional munitions

IED

improvised explosive device

IR

infrared

JP

Joint Publication

kg

kilogram

LAW

light anti-tank weapon

lb

pound

LDA

launcher danger area

LOA

letter of agreement

LSDZ

laser surface danger zone

m

meter

m³

cubic meter

MAAWS

multi-role antiarmor anti-personnel weapons system

MAM

Munition Adapter Module

MCCDC

Marine Corps Combat Development Command

MCO

Marine Corps order

MDI

modernized demolition initiator

MEA

mission essential area

METL

mission-essential task list

mg/m

milligram/meters

MHz

megahertz

MIL-HDBK

Military Handbook

MLRS

Multiple Launch Rocket System

mm

millimeter

MOPP

mission oriented protective posture

MOS

military occupational specialty

MPE

maximum permissible exposure

m/s

meters per second

MSD

minimum safe distance

MSL

mean sea level

MTL

missile target line

NAVSUP

U.S. Naval Supply Systems Command

NCO

noncommissioned officer

NLW

nonlethal weapon

NR

not required

NVD

night vision devices

ODCS

Office of the Deputy Chief of Staff

OIC

officer in charge

PE

probable error

PPE

personal protective equipment

QE

quadrant elevation

RCO

range control officer

RRPR

reduced range practice rocket

RSO

range safety officer

RW

rotary wing

SARSA

Small Arms Range Safety Area

SDZ

surface danger zone

SESAMS

Special Effects Small Arms Marking System

SLAP

saboted light armor penetrator

SMAW

shoulder-launched multipurpose assault weapon

SOP

standard operating procedure

SOUM

safety of use message

SRSO

senior range safety officer

SUA

special use airspace

TA

terephthalic acid

TB

technical bulletin

T

time

TC

training circular

TM

technical manual

TNT

trinitrotoluene

TOW

tube-launched, optically tracked, wire-guided

TP

training practice

TRADOC

U.S. Army Training and Doctrine Command

UAS

Unmanned Aircraft System

USACE

U.S. Army Corps of Engineers

USATCES

U.S. Army Technical Center for Explosives Safety

VMC

visual meteorological conditions

VT

variable time

WP

white phosphorous

Section II**Terms****140 dBP contour**

The distance at which the impulse noise produced by the weapon or explosive is 140 decibels peak level. See also hearing hazard zone.

ammunition lot

A quantity of components, each of which is manufactured by one manufacturer under uniform conditions, and which is expected to function in a uniform manner. The lot is designated and identified by assignment of an ammunition lot number and preparation of an ammunition data card.

Angle P

The angle beginning at the firing point, located to the left and right of the dispersion area, which defines the area which contains projectiles after making initial contact with the target medium.

Angle Q

The angle beginning at distance Y, located to the left and right of the dispersion area, which defines the area which contains projectiles after making initial contact with the impact medium.

approved hearing protector (or protection)

Hearing protector types that are approved for use by the Army and are listed in DA Pam 40-501.

Area A

The secondary danger area (buffer zone) that laterally parallels the impact area or ricochet area (depending on the weapon system) and contains fragments, debris, and components from frangible or explosive projectiles and warheads functioning on the right or left edge of the impact area or ricochet area.

Area B

The secondary danger area (buffer zone) on the downrange side of the impact area and Area A which contains fragments, debris, and components from frangible or exploding projectiles and warheads functioning on the far edge of the impact area and Area A.

Area C

The secondary danger area (buffer zone) on the up range side of the impact area and parallel to Area B which contains fragments, debris, and components from frangible or exploding projectiles and warheads functioning on the near edge of the impact area.

Area D

The safe area between Areas C and E for indirect, overhead fire of unprotected personnel in training.

Area E

The danger area between an indirect fire weapon system and Area D. This area is endangered by muzzle debris, overpressure, blast, and hazardous impulse noise. Personnel in service batteries firing from approved tactical configurations may occupy Area E.

Area F

The danger area to the rear of a weapon system that is endangered by back-blast debris, overpressure, blast, and hazardous impulse noise.

Area H

The area to the rear of a weapon system (for example, TOW missile) that contains warhead particles (collapsed shape charge and warhead fragments) during an "eject only" firing event.

Area I

The area immediately in front of certain missile weapon systems designated as the initial zone of impact for "eject only" firing events. Area I may not be occupied under deviation.

Area R

The portion of the SDZ behind the firer where personnel, equipment and facilities may be endangered by ricochets to the rear of the firing line.

Army Special Operations Forces

Those active and reserve component Army forces designated by the Secretary of Defense that are specifically organized, trained, and equipped to conduct and support special operations.

assistant Range Safety Officer

Officer, WO, or NCO designated and briefed by the OIC and RSO, who assists the RSO in carrying out the safety responsibilities for the range or activity.

backstop, laser

Opaque structures or terrain in the controlled area of a LSDZ such as a hill, dense tree line, or a windowless building that would completely obstruct any view beyond it and completely terminate a laser beam that may miss the target.

barrier

A permanent or temporary impediment to foot and or vehicular traffic which personnel are prohibited to pass without approval from the RMA (Army), range control (Marine Corps). A barrier may be sentinel, wire fencing, gate, sign, or other access-limiting device.

buttoned-up

All hatch covers are in a closed and secure position.

cease-fire

A command given by anyone observing an unsafe firing condition on any training complex to immediately terminate an active (hot, wet) firing status of a weapon system(s).

central register

An official record of range safety deviations held at the respective ACOM/ASCC/DRU.

certified ammunition

Ammunition, to include fuzes, propellants, and projectiles, which have been cleared by the U.S. Army Materiel Command for overhead fire of unprotected personnel.

cold firing status

A firing condition where authorization to fire a weapon system has not been given or has been revoked by the installation range operations firing desk (Army), range control office (Marine Corps). Also referred to as a dry firing status.

combined arms live-fire exercises (Army)/combined arms exercise (Marine Corps)

A combat exercise in which Army/Marine Corps combined arms teams in combat formation conduct coordinated combat firing and maneuver practice in executing the assault, seizure, and defense of appropriate objectives. Tactical air support may be included.

command responsibility

As it relates to range safety, commanders down the entire chain of command are responsible for the safety of their personnel.

conservation

The protection, improvement, and use of natural resources according to principles that will provide optimum public benefit and support of military operations.

contaminated area

Any area where there are known or suspected unexploded munitions (dud ammunition or explosives) regardless of type.

control tower

A structure usually situated behind the firing line or position from which range operations of a training event is controlled.

cookoff

A functioning of any or all of explosive components due to high temperatures within a weapon system.

crew-served weapon system

Any weapon system requiring two or more personnel to fire the system.

cross-sectional terrain profile

A profile of the SDZ being considered for deviation at a point laterally downrange where a hill mass is expected to attenuate projectiles and/or hazardous fragments.

decibel peak level

A logarithmic method of expressing the peak pressure caused by an explosion.

dedicated impact area

See impact area.

deviation

A departure from the requirements of this pamphlet and the policy in AR 385–63/ MCO 3570.1C.

direct fire

Fire delivered on a target when the weapon system is laid by sighting directly on the target using the weapon system sighting equipment.

dispersion area

The area within the SDZ located between the GTL and the ricochet area. This area accounts for human error, gun or cannon tube wear, propellant temperature, and so forth.

Distance D

Distance along specific angle, measured from the weapon target line, at the firing position down range for selected direct fire weapons. Distance D defines maximum projectile distance along this line.

Distance L

The distance down range from the launch point where the launch dispersion angle intersects the flight corridor boundaries for the PATRIOT missile.

Distance W

The maximum lateral distance a projectile will ricochet after impacting within the dispersion area. Distance W defines the maximum lateral edge of the ricochet area.

Distance X

The maximum distance a projectile (to include guided missiles and rockets) will travel when fired or launched at a given quadrant elevation with a given charge or propulsion system.

Distance Y

The maximum distance downrange at which a lateral ricochet is expected to occur when a projectile is fired at a given quadrant elevation.

double hearing protector (or protection)

Wearing earplugs in combination with noise muffs or noise attenuating helmets. Impulse levels can be so high that single hearing protection does not adequately protect hearing.

downrange

A descriptive term used to address the orientation of personnel, materiel, or property relative to the direction or path of

ammunition and or explosives (to include guided missiles and rockets) fired or launched from weapon systems. The direction of orientation is from the firing line or position toward the target.

dud

An explosive item or component of a weapon system that fails to function as intended when fired.

eject only firing event

A firing sequence where the launch motor of a missile functions, ejecting the missile out of the launcher, but the flight motor fails to ignite, causing the missile to tumble. As the missile tumbles and strikes the ground, sufficient G-Force initiates the warhead causing warhead particles to be projected outward.

far edge

The boundary of the impact area that borders the outside edge of Area B and is farthest from the firing point or position.

field expedient explosive device

A standard item of explosive that is combined with other standard explosive items or non-explosive items using techniques and procedures outlined in doctrinal publications (FMs and TMs).

final safety acceptance inspection

ACOMs, ASCCs, and DRUs safety inspection of new construction or modification of a range prior to release from the contractor or other contracting agent, Government or non-Government.

firing lane

The area within which a weapon system is fired. It consists of a start-fire line, cease fire-disarm line, and left and right limits of fire.

firing line

The line which consists of firing points or positions, from which weapon systems are fired downrange.

firing position

The point or location at which a weapon system (excluding demolitions) is placed for firing. For demolitions, the firing position is the point or location at which the firing crew is located during demolition operations.

flak jacket

Fragmentation body armor protective vest (CTA 50-900 update.)

fork

The change in angle of elevation necessary to produce a change to the center of impact equivalent to four probable errors.

guided missile

An unmanned vehicle moving above the surface of the earth whose trajectory or flight is capable of being altered by an external or internal mechanism.

gun target line

An imaginary line drawn between the firing position and target position. Also referred to as the line of fire.

HC smoke

Hexachloroethane-zinc oxide used to generate screening smoke.

hangfire

An undesired delay in the functioning of a firing system. A hangfire for a rocket occurs if the rocket propellant is ignited by the firing impulse but the rocket fails to exit the launcher within the expected time.

hearing hazard, hearing hazard zone

All personnel exposed to levels of 140 dBp and above must wear hearing protection. The area where the impulse noise levels are 140 dBp or higher and hearing protection is required.

hearing protection zone

Area on the range within which all personnel must wear hearing protection during weapons fire. It may be larger than the hearing hazard zone, but never smaller.

high-hazard impact area

See impact area.

hot firing status

A firing condition where authorization to fire a weapon system has been given by the installation range operations firing desk (Army), range control office (Marine Corps). Also referred to as a wet firing status.

impact area

The ground and associated airspace within the training complex used to contain fired, placed, dropped, thrown, or launched AE, and the resulting fragments, debris, and components from various weapon systems. Indirect fire weapon system impact areas include probable error for range and deflection. Direct fire weapon system impact areas encompass the total SDZ from the firing point or position downrange to Distance X. It also includes Area B when required.

a. Temporary impact area. An impact area within the training complex used for a limited period of time to contain fired, placed, dropped, thrown, or launched AE and the resulting fragments, debris, and components. Temporary impact areas are normally used for non-dud producing AE, and should be able to be cleared and returned to other training support following termination of firing.

b. Dedicated impact area. An impact area that is permanently designated within the training complex and used indefinitely to contain fired, placed, dropped, thrown, or launched AE and the resulting fragments, debris, and components. Dedicated impact areas are normally used for non-sensitive AE.

c. High-hazard impact area. An impact area that is permanently designated within the training complex and used to contain sensitive high explosive AE and the resulting fragments, debris, and components. High hazard impact areas are normally established as part of dedicated impact areas where access is limited and strictly controlled due to the extreme hazard of dud ordnance (for example, ICM, HEAT, 40-mm, and other highly sensitive AE.)

improved conventional munitions

Munitions characterized by the delivery of two or more antipersonnel or antimateriel and/or antiarmor sub-munitions.

indirect fire

Fire delivered on a target when the weapon system is not in line of sight with the target.

installation

An aggregation of contiguous or near contiguous, common mission supporting real property holdings under the jurisdiction of the Department of Defense within and outside the continental United States. Examples include, but are not limited to, posts, camps, bases, and stations.

installation Range Management Authority (Army), Range Control Officer (Marine Corps)

A commissioned officer, WO, NCO, or civilian who serves as the central point of control and coordination for all activities conducted within the installation/community training complex and implements and enforces the installation/community range safety program. This may include the scheduling and maintenance of the training complex.

intrabeam viewing

Looking directly into the path of a laser beam or reflected beam.

intra-line distances

The distance used for separating certain specified areas and locations within explosive establishments.

instructor pilot

A qualified warrant or commissioned officer that is placed on military orders and is assigned the responsibility for the safe operation of assigned aircraft and associated weapon systems.

large rocket

A stabilized, free ballistic trajectory, long range field artillery type rocket with a range capability of greater than 100 km when using a nonnuclear warhead.

laser

A device capable of producing a narrow beam of intense light (LASER-light amplification by stimulated emission of radiation). See TB MED 524, MIL-HDBK-828B, and JP 3-09 for more information on lasers.

laser buffer zone

A safety margin on either side, above, and below the approved target area extending to a distance at which the beam is terminated by a backstop extending across the target zone or the NOHD limit is reached. A vertical buffer zone covers the angular distances below the highest point on a backstop or above the non-lasing area. The laser horizontal buffer zone covers the angular distance to the left of the left most target and to the right of the right most target.

laser range finder

A range finder employing a laser device to emit a pulsed laser beam that is aimed at the target. The range is determined automatically by electronically measuring the time it takes for the light beam to travel from the laser to the target, be reflected from the target, and return to the range finder.

laser safety eyewear

Protective eyewear designed specifically to permit the user to be exposed to either a direct or reflected laser beam from a specific laser device without eye injury.

laser surface danger zone

A V-shaped zone designed to contain a laser beam (while lasing) with buffer zones on either side, above, and below the approved target.

logistics assistance representative

Department of Army civilian personnel in the grade of GS-11 and above who have received training in specific weapon systems and are qualified in accordance with AR 75-1 to assist in performing malfunction investigations.

low-angle fire

Fire delivered at angles of elevation equal to or below the angle corresponding to the maximum range of the gun and ammunition.

malfunction

Failure of an ammunition item to function as expected when fired, launched, or when explosive items function under conditions that should not cause functioning. Malfunctions include hangfires, misfires, duds, abnormal functioning and premature functioning of explosive items under normal handling, maintenance, storage, transportation, and tactical deployment. Malfunctions do not include accidents or incidents that arise solely from negligence, malpractice, or situations such as vehicle accidents or fires.

military operations in urban terrain

A terrain complex where manmade construction impacts on the tactical options available to commanders. Military operations in urban terrain facilities replicate urban sprawl environments.

misfire

A complete failure to fire that is not necessarily hazardous. Because it cannot be readily distinguished from a delay in functioning (hangfire), it must be handled as worst case in accordance with procedures for the weapon system.

mission-essential area

The area within the SDZ located adjacent to the impact area that is allowed to be occupied only by essential personnel needed to accomplish the assigned task or mission.

mission-essential personnel

Those individuals who are directly involved or in support of weapon systems firing without whom the firing mission could not take place.

navigable waterway

Any body of water open to the free movement of marine vessels.

near edge

The boundary of the impact area that borders Area C and is nearest to the firing point or position.

nominal ocular hazard distance

The intrabeam distance within which the laser beam's irradiance or radiant exposure falls below the applicable exposure limit.

nominal ocular hazard distance-optical

The nominal ocular hazard distance when viewed with optical aids.

nominal ocular hazard distance-magnified

The nominal ocular hazard distance for intrabeam viewing through 7x50 binoculars that transmit 70 percent at 1064 nanometers and 85 percent at 694.3 nanometers.

nominal ocular hazard distance-single

The nominal ocular hazard distance for a laser device operating in the single pulse mode.

non-participating personnel

Personnel that are not under the direct OIC/RSO control/responsibility and are not involved in the overall exercise/training event in any way.

nonstandard explosive item

An explosive device, material, or component that has not been through a DoD Service munitions qualification process, such as being type classified by AMC, or is a standard explosive item that has been altered to change its characteristics and function.

Officer In Charge

The officer, WO, or NCO responsible for personnel conducting firing or operations within the training complex.

operational area

Multiple firing points contained in a designated area from which weapons such as artillery can be fired safely.

operational range

A range that is under the jurisdiction, custody, or control of the Secretary of Defense and- that is used for range activities, or although not currently being used for range activities, that is still considered by the Secretary to be a range and has not been put to a new use that is incompatible with range activities.

overhead fire

Weapon system firing that is delivered over the heads of unprotected personnel in training or personnel located anywhere in the SDZ.

participating personnel

Personnel that are under direct OIC/RSO control/responsibility participating in or part of an overall exercise/training event and directly involved in some or all of the tasks or events associated with the overall exercise/training.

primary danger area

An area within the SDZ where hazards are known to exist and in which no unprotected Soldier/Marine or materiel is permitted since injury or death to such personnel and damage to materiel is probable. Target, dispersion, and ricochet areas are primary danger areas.

probable error

A measure of the impact distribution in the dispersion pattern around the center of impact dimensionally expressed in firing tables as one interval of the dispersion rectangle.

proper eye protection (or eye armor)

Approved eye protection, as a minimum, when required by safety and or installation/community range regulations and or standing operating procedures.

proper hearing protection

Approved single or double hearing protection, as a minimum, when required by safety or installation range regulations or standing operating procedures.

public traffic route distance

The distance in feet used to separate any public highway, navigable stream, passenger railroad, or aircraft taxiway from potential explosion sites. (See DA Pam 385–64 for quantity-distance tables.)

quality assurance specialist (ammunition surveillance)

Department of Army Civilian personnel in the grade of GS–09 or above who have received 2 years of ammunition training and are qualified in accordance with AR 75–1 to assist in performing malfunction investigations.

range error

Difference between the range to the point of impact of a particular projectile and the range to the mean point of impact of a group of artillery projectiles fired with the same data.

range officer

See “installation Range Management Authority” (Army), Range Control Officer (Marine Corps)”.

range personnel

Persons designated to assist the RMA (Army), RCO (Marine Corps) in executing the Installation Range Safety Program.

Range Safety Officer

The officer, WO, or NCO who is the direct representative of the OIC of firing or other operations. The RSO is responsible to the OIC for insuring the adequacy of safety of firing, training operations, and ensuring compliance with laser range safety requirements and local standing operating procedures.

rear range

The orientation of personnel, materiel, or property to the rear of a weapon system.

ricochet area

The area located to the left and right of the dispersion area that contains projectiles after making initial contact with the target medium. For SDZs having Angles P and Q, it is also the area located to the left and right of the dispersion area. The ricochet area is defined by Distance W.

right and left range

The orientation of personnel, materiel, or property within the SDZ relative to the GTL.

risk management

The process of identifying, assessing, and controlling risks arising from operational factors and making decisions that balance risk cost with mission benefits.

safe area

An area within the SDZ where the probability of injury is minimal to exposed Soldiers/Marines or those provided with protective cover.

safety certification program

A program established and maintained by the battalion/squadron commander to ensure that personnel under their command designated as OICs and RSOs are competent and qualified to carry out the responsibilities and duties of the respective positions.

secondary danger zone

An area outside of the primary danger area which provides containment of fragments, debris, and components from frangible or high explosive projectiles and warheads functioning on the far edge of the primary danger area. Areas A, B, and C are secondary danger areas.

senior Range Safety Officer

The officer designated as the RSO for crew served guided missiles and heavy rockets, excluding direct fire antitank missiles and rockets.

single hearing protector (or protection)

Wearing either earplugs, noise muffs or noise attenuating helmets.

special use airspace

Airspace of defined dimension identified by an area on the surface of the earth wherein activities must be confined because of their nature and or wherein limitations may be imposed upon aircraft operations that are not a part of those activities.

specularly reflective surface

A mirror like surface capable of reflecting a laser beam.

subcaliber ammunition

Practice ammunition of a caliber smaller than standard for the weapon system. Subcaliber ammunition is economical and may be fired in relatively smaller areas. It is used with special subcaliber equipment and devices to simulate firing conditions with standard ammunition.

surface danger zone

The ground and airspace designated within the training complex (to include associated safety areas) for vertical and lateral containment of projectiles, fragments, debris, and components resulting from the firing, launching, or detonation of weapon systems to include explosives and demolitions.

target area

The point or location within the SDZ where targets (static/moving, point/array) are emplaced for weapon system engagement. For demolitions, it is the point or location where explosive charges are emplaced.

temporary impact area

See impact area.

training complex

Firing ranges and weapons training facilities designated for firing AE, heavy rockets, and guided missiles for training and target practice, and non-live fire sites for maneuver exercises and operations.

training site

A designated location to train, usually within the confines of the training complex. A specific firing range and or weapons training facility designated for firing ammunition and explosives, heavy rockets, and guided missiles for training and target practice, and non-live-fire sites for maneuver exercises and operations.

trajectory safety officer

Assists the SRSO and is responsible for determining when crew served guided missiles and heavy rockets should be destroyed or thrust terminated.

unexploded ordnance

AE which have been primed, fused, armed, or otherwise prepared for action and which have been fired, dropped, launched, projected or placed in such a manner as to constitute a hazard to operations, installations/communities, personnel, or materiel, and remains unexploded either by malfunction or design or any other cause.

unit commander

A commander of an Army or Marine Corps element whose structure is prescribed by competent authority, such as a table of organization and equipment.

uprange

The orientation of personnel, materiel, or property relative to the direction or path of AEs (to include guided missiles and rockets) fired or launched from weapon systems. The orientation is from the target area or impact area toward the firing line or position.

weapon system qualified

An individual, military or civilian, who has completed a standard program of instruction for a particular weapon system.

weapon system knowledgeable

An individual, military or civilian, who has completed a standard program of instruction for a particular weapon system or has completed familiarization training established by the senior commander. Familiarization training may involve live-fire training. Familiarization training should be approved by proponent school.

Section III

Special Abbreviations and Terms

APFSDS-T

armor piercing, fin-stabilized discarding sabot-tracer

BB

bunker buster

CAX

combined arms exercise

CPR

common practice round

CREW

Counter Radio-controlled improvised explosive device Electronic Warfare

DAM

Demolition Attack Munition

DAR

Department of the Army representative

dBp

decibels peak

DMOIC

Digital Missile Ordnance Inhibit Circuit

EFSS

Expeditionary Fire Support System

ENA

exposure not allowed

FAH

final attack heading

FS

sulfur trioxide-chlorosulfonic acid solution

GREM

Grenade Rifle Entry Munition

HEAA

high explosive anti-armor assault

IMOIC

Improved Missile Ordnance Inhibit Circuit

IP

intersecting point

JPADS

Joint Precision Airdrop System

JTAC

joint terminal attack controller

LOAL

Lock-On-After-Launch

LOBL

Lock-On-Before-Launch

MAE

maximum allowable environment

Max Ord

maximum ordinate

MCCM

modular crowd control munitions

MEP

mission essential personnel

MGL

Miniature Grenade Launcher

MOIC

Missile Ordnance Inhibit Circuit

MOICE

MOIC Enhancement

NAVAIR

Naval Air

NE

novel explosive

NHA

noise hazard area

NL/TLMS

non-lethal/tube launched munition system

NOHD

nominal ocular hazard distance

NOLSC

Naval Operational Logistics Support Center

OPAREA

operational area

ORAHT

On Range Ammunition Handling Tool

RLEM

Rifle Launched Entry Munition

RMA

range management authority

RMTK

Range Managers Toolkit

SA

stay above

SB

stay below

SLAM

Selectable Lightweight Attack Munition

TCM Ranges

TRADOC Capability Manager Ranges

TP-T

target practice-tracer

TPCSDS-T

target practice, cone-stabilized discarding sabot-tracer

UXO

unexploded ordnance

V/m

volts per meter

VI

vertical interval

WDZ

weapon danger zone

UNCLASSIFIED

PIN 079965-000