

600 Yards

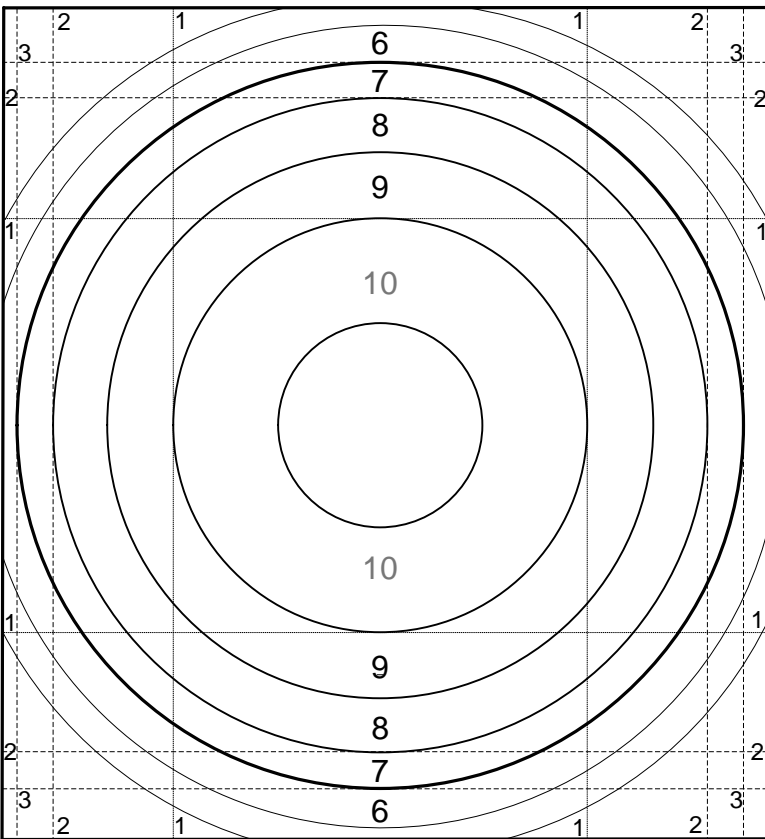

Place		Date										
Target No.		Relay										
Time		Time										
Rifle		Ammunition										
Light Direction		Wind Direction										
Temp	MPH	Mirage	MM / Sights									
Elevation Zero		Windage Zero										
Elevation Used		Windage Used										
0-1-T50%	SS1 SS2	1	2	3	4	5	6	7	8	9	10	TOTAL
Elevation												
Windage												
Call												
Value												
GRP 8/04/05	SS3 SS4	11	12	13	14	15	16	17	18	19	20	TOTAL
Elevation												
Windage												
Call												
Value												
Reloading Information		Sights		Score								
Brass	Primers	E on										
Powder	Gr. Wt.	W on										
Bullet	OAL											

600 Yards

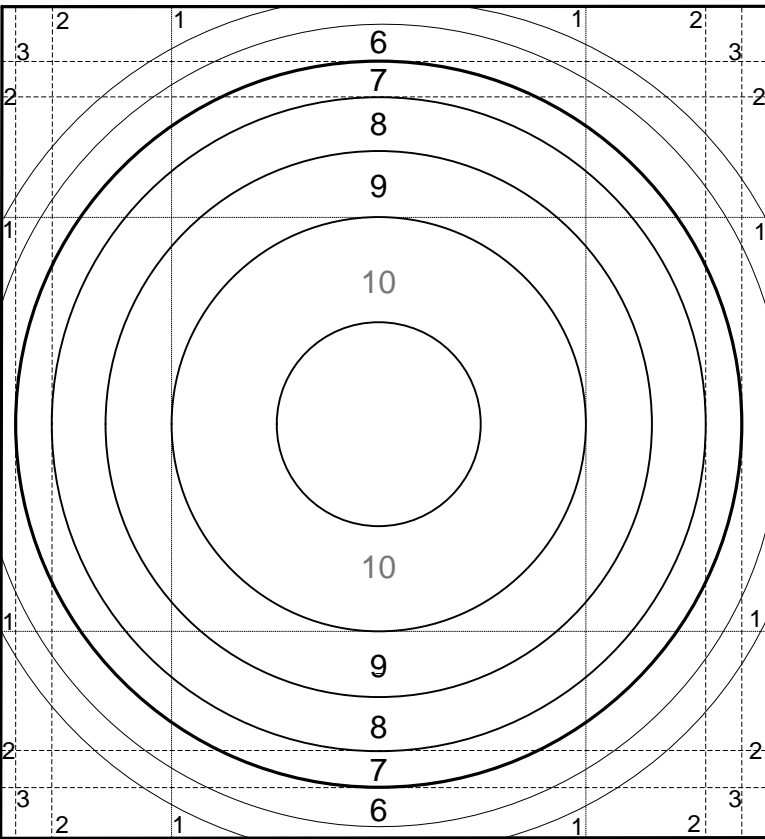

Place		Date										
Target No.		Relay										
Time		Time										
Rifle		Ammunition										
Light Direction		Wind Direction										
Temp	MPH	Mirage	MM / Sights									
Elevation Zero		Windage Zero										
Elevation Used		Windage Used										
0-1-T50%	SS1 SS2	1	2	3	4	5	6	7	8	9	10	TOTAL
Elevation												
Windage												
Call												
Value												
GRP 8/04/05	SS3 SS4	11	12	13	14	15	16	17	18	19	20	TOTAL
Elevation												
Windage												
Call												
Value												
Reloading Information		Sights		Score								
Brass	Primers	E on										
Powder	Gr. Wt.	W on										
Bullet	OAL											