

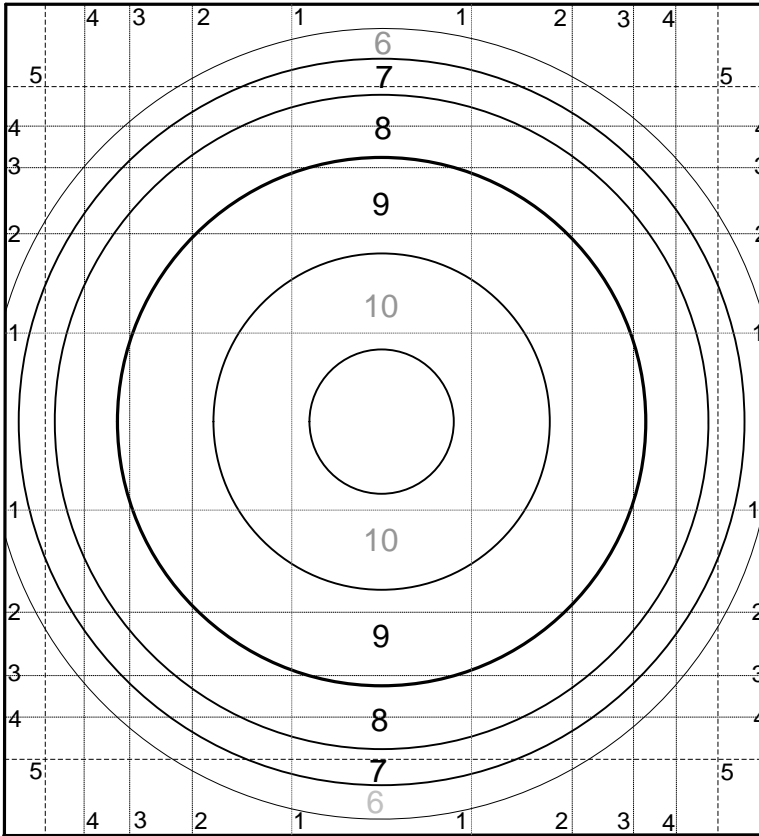











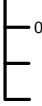





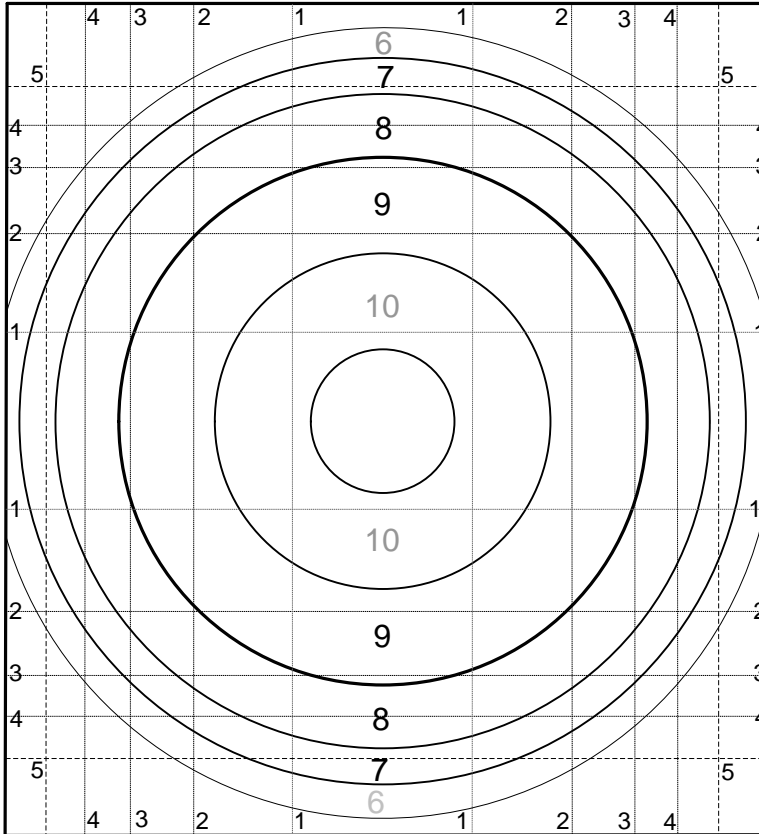

# 200 Yards Slow Fire

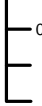

Place		Date	
Target No.		Relay	
		Time	
Rifle		Ammunition	
Light Direction		Wind Direction	
Temp	MPH	Mirage	MM / Sights
			
Elevation Zero		Windage Zero	
Elevation Used		Windage Used	
0-1-T90%	SS1	SS2	1 2 3 4 5 6 7 8 9 10
Elevation			
Windage			
Call			
Value			
GRP 8/04/05	SS3	SS4	11 12 13 14 15 16 17 18 19 20
Elevation			
Windage			
Call			
Value			
Reloading Information		Sights	
Brass	Primers	E on	
Powder	Gr. Wt.	W on	
Bullet	OAL	Score	

# 200 Yards Slow Fire



Place		Date	
Target No.		Relay	
		Time	
Rifle		Ammunition	
Light Direction		Wind Direction	
Temp	MPH	Mirage	MM / Sights
			
Elevation Zero		Windage Zero	
Elevation Used		Windage Used	
0-1-T90%	SS1	SS2	1 2 3 4 5 6 7 8 9 10
Elevation			
Windage			
Call			
Value			
GRP 8/04/05	SS3	SS4	11 12 13 14 15 16 17 18 19 20
Elevation			
Windage			
Call			
Value			
Reloading Information		Sights	
Brass	Primers	E on	
Powder	Gr. Wt.	W on	
Bullet	OAL	Score	